

Scatola art. 644.0240 75x230x75mm
 Junction Box item 644.0240 75x230x75

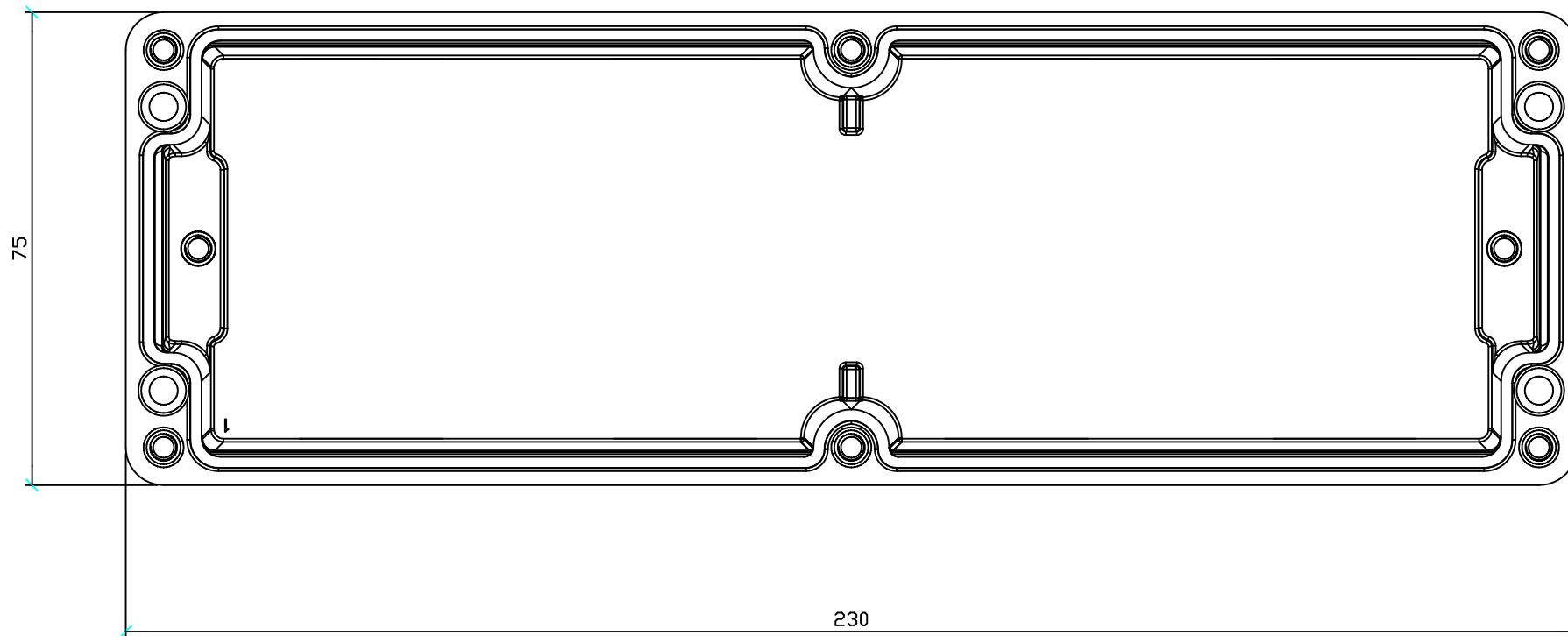

N.6 tappi M20 e N.2 tappi M25 e piastra di continuità



APPROVATO	RESP. UTE
REV.	MODIFICA

DATA	14/05/2009
DISEG.	F.Verzeroli
VISTO	F.Verzeroli
APPR.	

SCAME
 PARRE - (Bergamo)

A termine di legge ci riserviamo la proprieta' di questo disegno con divieto di riproduzione e di renderlo comunque noto a terzi o a ditte concorrenti

RS Components		
AF 01407_8	644.0240-RS02	FOGLIO 2 DI 3
		SEGUE 3

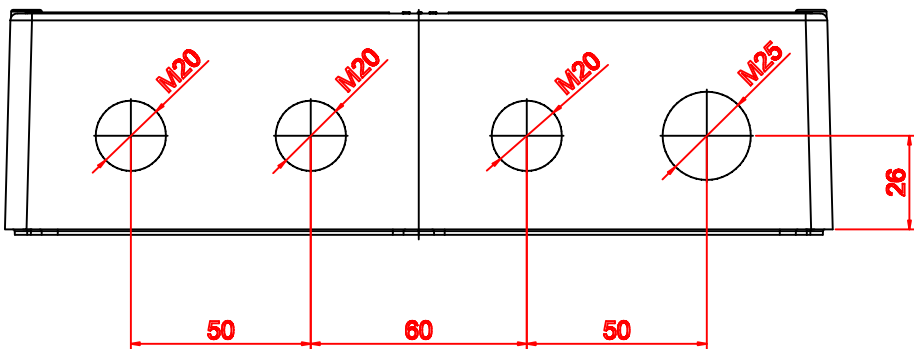
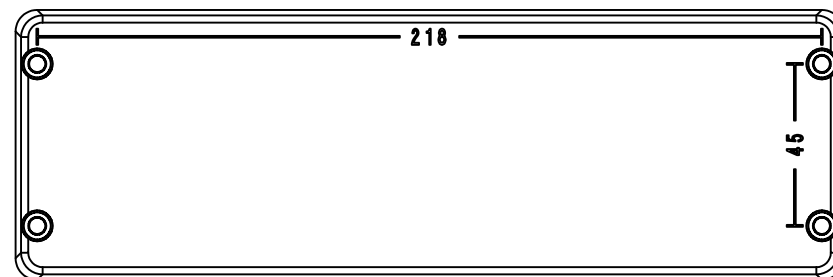
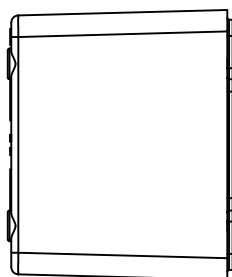
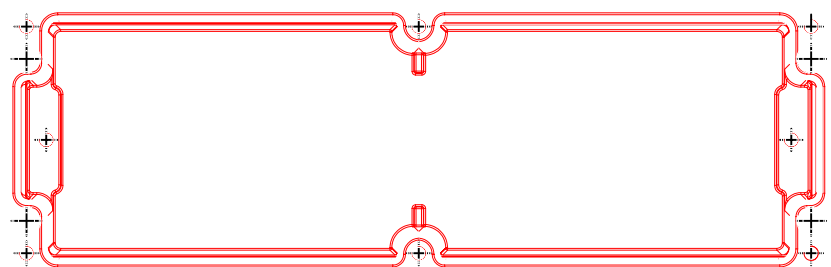
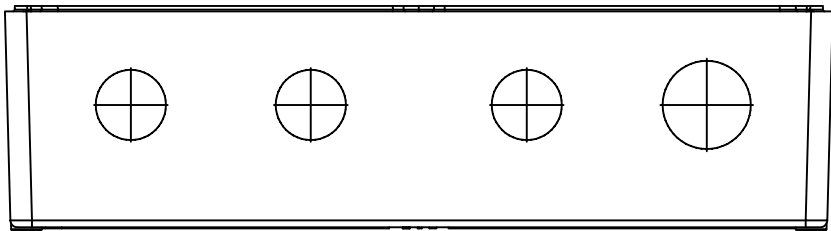

REV.	MODIFICA
------	----------

APPROVATO RESP. UTE

DATA 14/05/2009
 DISEG. F.Verzeroli
 VISTO F.Verzeroli
 APPR.

SCAME
 PARRE - (Bergamo)

A termine di legge ci riserviamo la proprieta' di questo disegno con divieto di riproduzione e di renderlo comunque noto a terzi o a ditte concorrenti

RS Components

AF 01407_8

SC88003

FOGLIO	2 DI	3
SEGUE		3

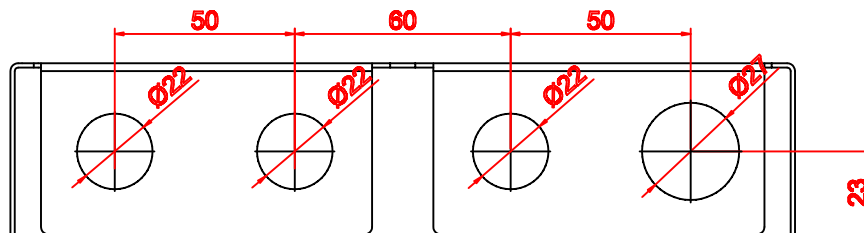
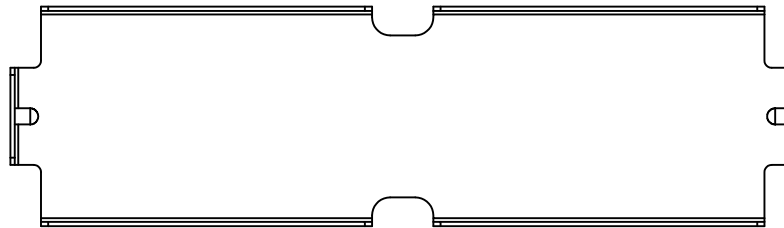
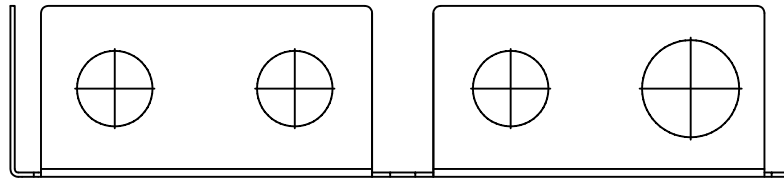

REV.	MODIFICA	APPROVATO RESP. UTE

DATA	14/05/2009
DISEG.	F.Verzeroli
VISTO	F.Verzeroli
APPR.	

SCAME
PARRE - (Bergamo)

A termine di legge ci riserviamo la proprieta' di questo disegno con divieto di riproduzione e di renderlo comunque noto a terzi o a ditte concorrenti

RS Components	
AF 01407_8	MP30041

Foglio	3 DI	3