



# WTB2S-2P3110

W2S-2

PHOTOELECTRIC SENSORS

**SICK**  
Sensor Intelligence.



### Ordering information

Type	Part no.
WTB2S-2P3110	1064395

Other models and accessories → [www.sick.com/W2S-2](http://www.sick.com/W2S-2)

Illustration may differ



### Detailed technical data

#### Features

<b>Sensor/ detection principle</b>	Photoelectric proximity sensor, Background suppression
<b>Dimensions (W x H x D)</b>	7.7 mm x 21.8 mm x 13.5 mm
<b>Housing design (light emission)</b>	Rectangular
<b>Sensing range max.</b>	1 mm ... 18 mm <sup>1)</sup>
<b>Sensing range</b>	3 mm ... 15 mm <sup>1)</sup>
<b>Background suppression typ. from</b>	20 mm
<b>Type of light</b>	Visible red light
<b>Light source</b>	PinPoint LED <sup>2)</sup>
<b>Light spot size (distance)</b>	Ø 2 mm (8 mm)
<b>Wave length</b>	640 nm
<b>Adjustment</b>	None
<b>Special applications</b>	Detecting small objects

<sup>1)</sup> Object with 90 % reflectance (referred to standard white, DIN 5033).

<sup>2)</sup> Average service life: 100,000 h at T<sub>J</sub> = +25 °C.

Mechanics/electronics

<b>Supply voltage</b>	10 V DC ... 30 V DC <sup>1)</sup>
<b>Ripple</b>	≤ 5 V <sub>pp</sub> <sup>2)</sup>
<b>Power consumption</b>	≤ 20 mA <sup>3)</sup>
<b>Switching output</b>	PNP
<b>Switching mode</b>	Light switching
<b>Output current I<sub>max.</sub></b>	< 50 mA
<b>Response time</b>	< 0.4 ms <sup>4)</sup>
<b>Switching frequency</b>	1,200 Hz <sup>5)</sup>
<b>Connection type</b>	Cable with connector M8, 3-pin, 200 mm <sup>6)</sup>
<b>Cable material</b>	PVC
<b>Cable diameter</b>	Ø 3 mm
<b>Circuit protection</b>	A <sup>7)</sup> B <sup>8)</sup> D <sup>9)</sup>
<b>Housing material</b>	Plastic, ABS/PC
<b>Optics material</b>	Plastic, PMMA
<b>Enclosure rating</b>	IP67
<b>Ambient operating temperature</b>	-25 °C ... +50 °C
<b>Ambient storage temperature</b>	-40 °C ... +75 °C
<b>UL File No.</b>	NRKH.E181493

1) Limit values.

2) May not exceed or fall below U<sub>v</sub> tolerances.

3) Without load.

4) Signal transit time with resistive load.

5) With light/dark ratio 1:1.

6) Do not bend below 0 °C.

7) A = V<sub>S</sub> connections reverse-polarity protected.

8) B = output reverse-polarity protected.

9) D = outputs overcurrent and short-circuit protected.

Classifications

<b>ECl@ss 5.0</b>	27270904
<b>ECl@ss 5.1.4</b>	27270904
<b>ECl@ss 6.0</b>	27270904
<b>ECl@ss 6.2</b>	27270904
<b>ECl@ss 7.0</b>	27270904
<b>ECl@ss 8.0</b>	27270904
<b>ECl@ss 8.1</b>	27270904
<b>ECl@ss 9.0</b>	27270904
<b>ETIM 5.0</b>	EC002719
<b>ETIM 6.0</b>	EC002719
<b>UNSPSC 16.0901</b>	39121528

### Connection diagram

cd-045

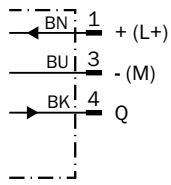

### Light spot size

WTB2S-2, 18 mm

Spot diameter in mm (inch)

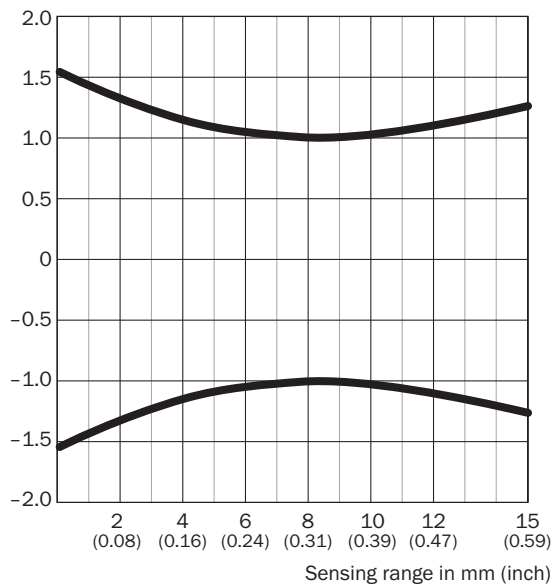

### Dimensions in mm (inch)

Sensing range	Spot diameter
<b>4</b> (0.16)	2.3 (0.09)
<b>8</b> (0.31)	2.0 (0.08)
<b>15</b> (0.59)	2.5 (0.10)

### Sensing range diagram

WTB2S-2, 18 mm

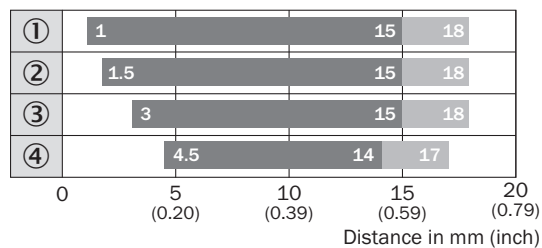

■ Sensing range    ■ Sensing range max.

- ① Sensing range on white, 90% remission
- ② Sensing range on gray, 18% remission
- ③ Sensing range on black, 6% remission
- ④ Sensing range on ultra black, 1% remission

**Dimensional drawing** (Dimensions in mm (inch))

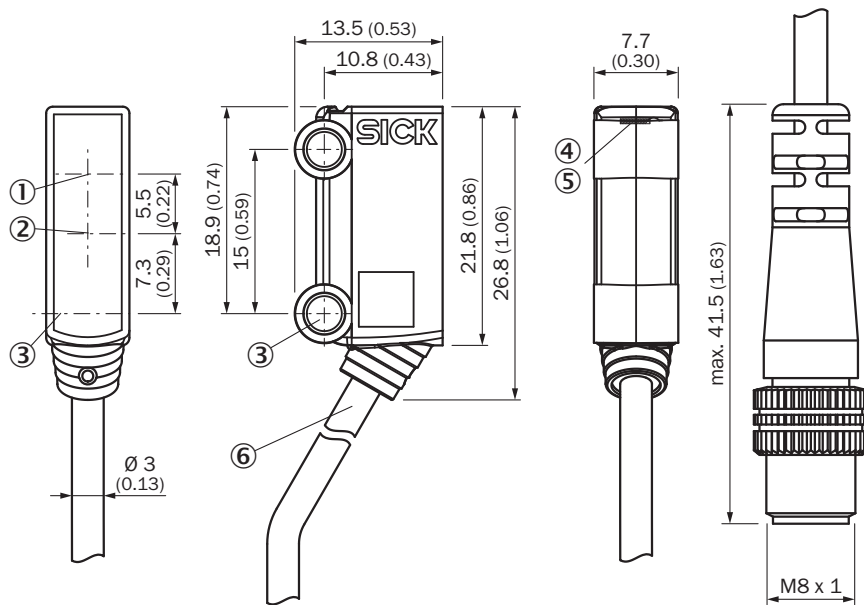

WTB2S-2, 18 mm, 36 mm, WTV2S-2



- ① Optical axis receiver
- ② Optical axis sender
- ③ Mounting hole, Ø 3.2 mm
- ④ LED indicator green: Supply voltage active
- ⑤ LED indicator yellow: Status of received light beam
- ⑥ Connection

**Recommended accessories**

Other models and accessories → [www.sick.com/W2S-2](http://www.sick.com/W2S-2)

	Brief description	Type	Part no.
<b>Mounting brackets and plates</b>			
	Mounting bracket for floor mounting, steel, zinc coated, without mounting hardware	BEF-W2S-A	4034748
	Mounting bracket for wall mounting, steel, zinc coated, without mounting hardware	BEF-W2S-B	4034749
<b>Terminal and alignment brackets</b>			
	Ball clamp bracket, Plastic, mounting hardware included	BEF-GH-MINI01	2023160
<b>Plug connectors and cables</b>			
	Head A: female connector, M8, 3-pin, straight, A-coded Head B: Flying leads Cable: Sensor/actuator cable, PVC, unshielded, 2 m	YF8U13-020VA1XLEAX	2095860
	Head A: female connector, M8, 3-pin, straight, A-coded Head B: Flying leads Cable: Sensor/actuator cable, PVC, unshielded, 5 m	YF8U13-050VA1XLEAX	2095884

	Brief description	Type	Part no.
	Head A: female connector, M8, 3-pin, angled, A-coded Head B: Flying leads Cable: Sensor/actuator cable, PVC, unshielded, 2 m	YG8U13-020VA1XLEAX	2096165
	Head A: female connector, M8, 3-pin, angled, A-coded Head B: Flying leads Cable: Sensor/actuator cable, PVC, unshielded, 5 m	YG8U13-050VA1XLEAX	2096166

## SICK AT A GLANCE

SICK is one of the leading manufacturers of intelligent sensors and sensor solutions for industrial applications. A unique range of products and services creates the perfect basis for controlling processes securely and efficiently, protecting individuals from accidents and preventing damage to the environment.

We have extensive experience in a wide range of industries and understand their processes and requirements. With intelligent sensors, we can deliver exactly what our customers need. In application centers in Europe, Asia and North America, system solutions are tested and optimized in accordance with customer specifications. All this makes us a reliable supplier and development partner.

Comprehensive services complete our offering: SICK LifeTime Services provide support throughout the machine life cycle and ensure safety and productivity.

For us, that is “Sensor Intelligence.”

## WORLDWIDE PRESENCE:

Contacts and other locations –[www.sick.com](http://www.sick.com)