

Sensor Solutions for Hoisting Applications



Telemecanique

Sensors

Simply easy!

> Telemecanique Sensors

Simply easy!

Simplicity



Expertise



Proximity



Telemecanique Sensors is a world-class global brand offering a comprehensive line of products with over 25,000 types of sensors, including limit switches, pressure sensors, photoelectric sensors and proximity sensors. In addition, we provide state-of-the-art RFID systems that are compatible with many PLC manufacturers.

Telemecanique Sensors has all the right agency approvals, such as IEC, NEMA, CE, CCC, UL, CSA, and EAC.

Telemecanique Sensors is focused on three core values — Simplicity, Proximity, and Expertise. We have become experts in factory automation sensors as well as specialists in demanding applications, making our customers' lives "Simply easy!"

> Innovation focus

OsiSense™ XUK9T offers dedicated functions for overhead cranes:
anti-collision and tandem



Robust detection

- Up to 70m (230 ft.) range using time-of-flight method
- Simple alignment with a reflector is allowed by a bright red laser spot

Improved operator safety

- When several cranes use the same rail, the risk of collisions or dropped load is avoided by the anti-collision function
- Monitoring the synchronization of two cranes to translate heavy or large loads is made possible with the tandem function

Easy installation and teach-in

- Compact size: 50mm x 50mm x 23mm (2" x 2" x 1")
- Teach-in button available on the device or via an external wire

> Overhead and gantry crane

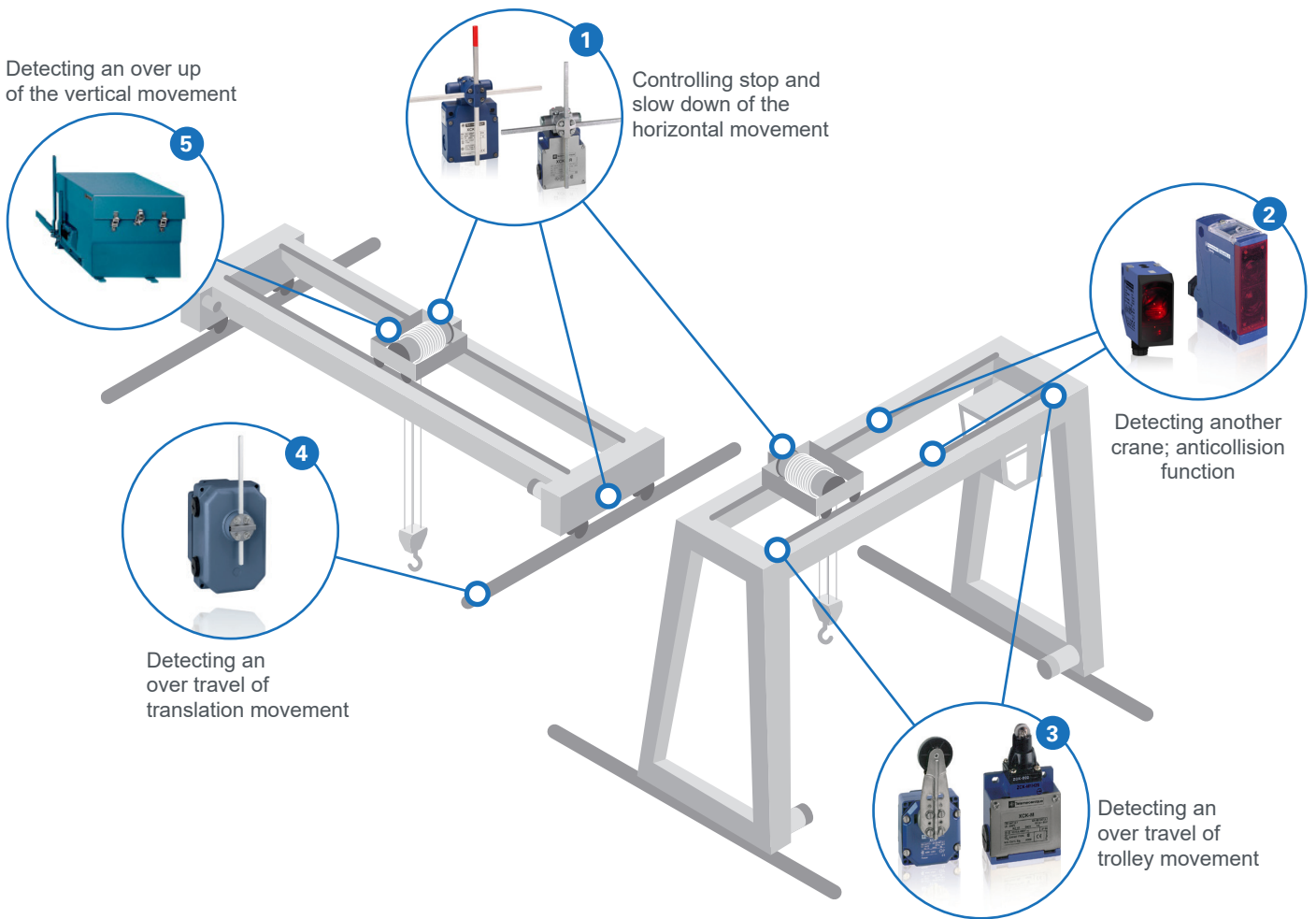

- 1 XCKVR / XCKMR Limit Switches 2 ways / 2 speeds by one single sensor, compactness and robustness with positivity.
- 2 XUX / XUK9T Photoelectric Sensors Long distance detection.
- 3 XCKM / XCR Limit Switches Robustness with positivity.
- 4 5 XF Limit Switch The ultimate hoisting protection.



> Mobile crane

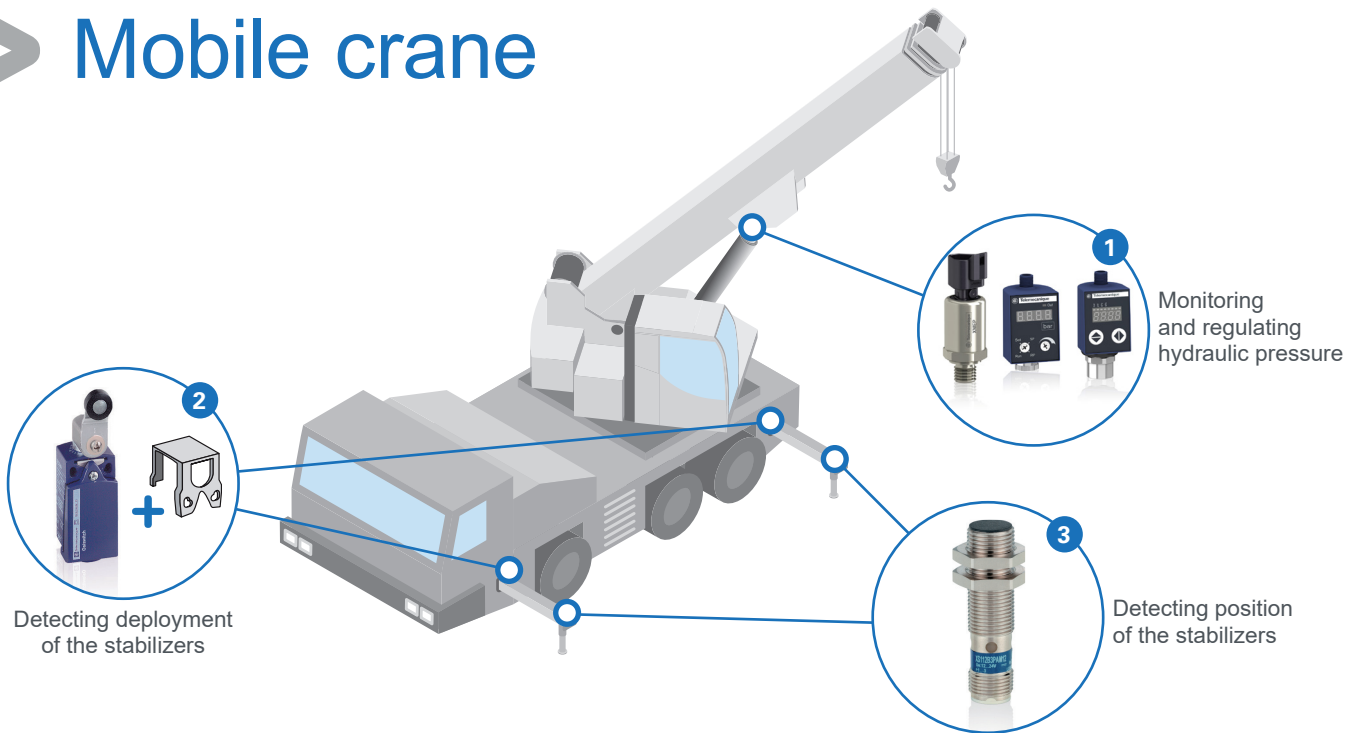

- 1 XMEP / XMLR / ZMLP Pressure Sensors / Monitor Compact and robust for reliable regulation.
- 2 XCKD Limit Switch + XCKZ05 Accessory Robust for increased resistance to impact.
- 3 XS Inductive Sensor Ease of installation and adjustable distance detection.

> Block hoist

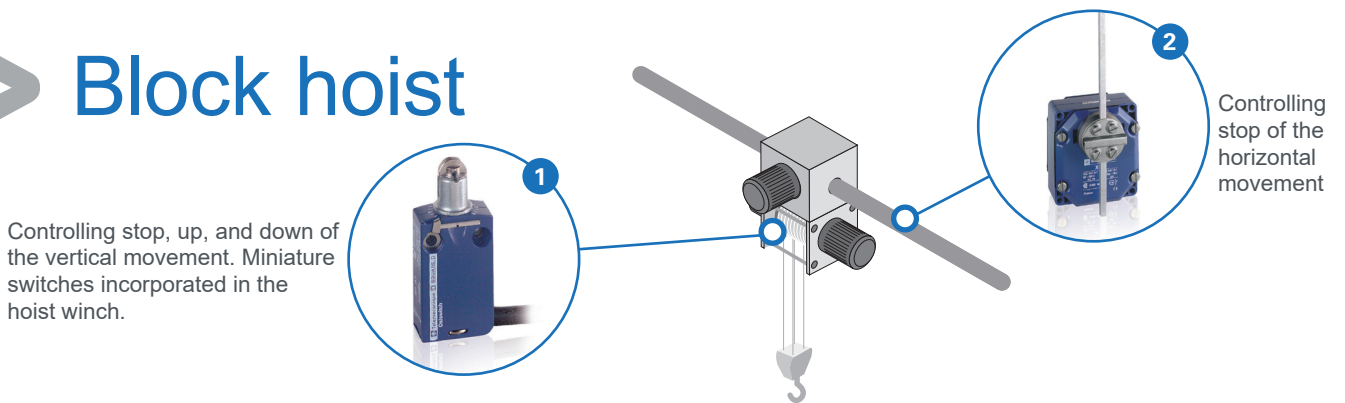

- 1 XCMD Limit Switch Compact with modular head for easy mechanical integration.
- 2 XCR Limit Switch 2 ways / 1 speed, compact and robust with positivity.



> Tower crane

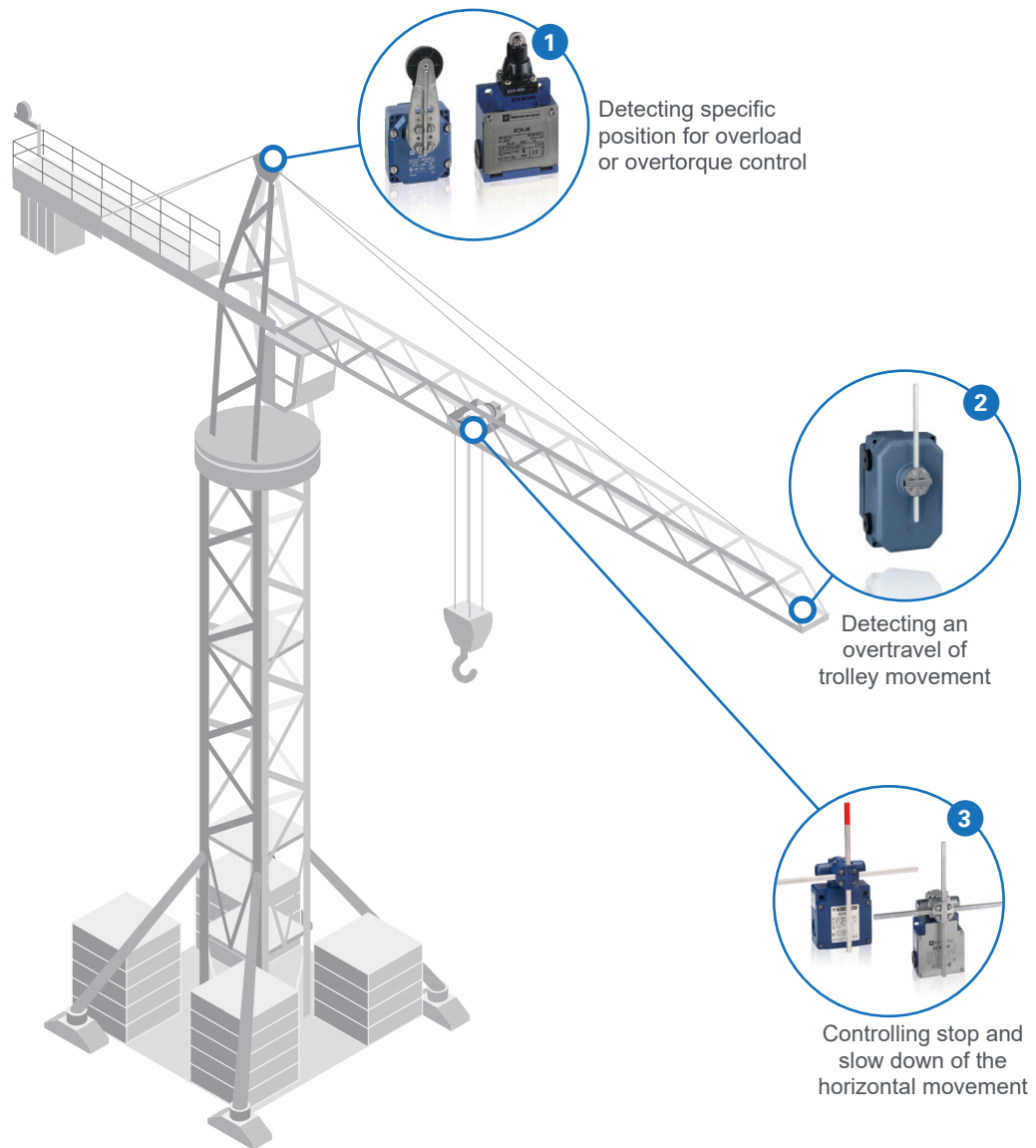

1 XCKM / XCR Limit Switches

Robust with positivity.

2 XF Limit Switch

The ultimate trolley protection.

3 XCKVR / XCKMR Limit Switches

2 ways / 2 speeds by one single sensor, compact and robust with positivity



> Harbour crane

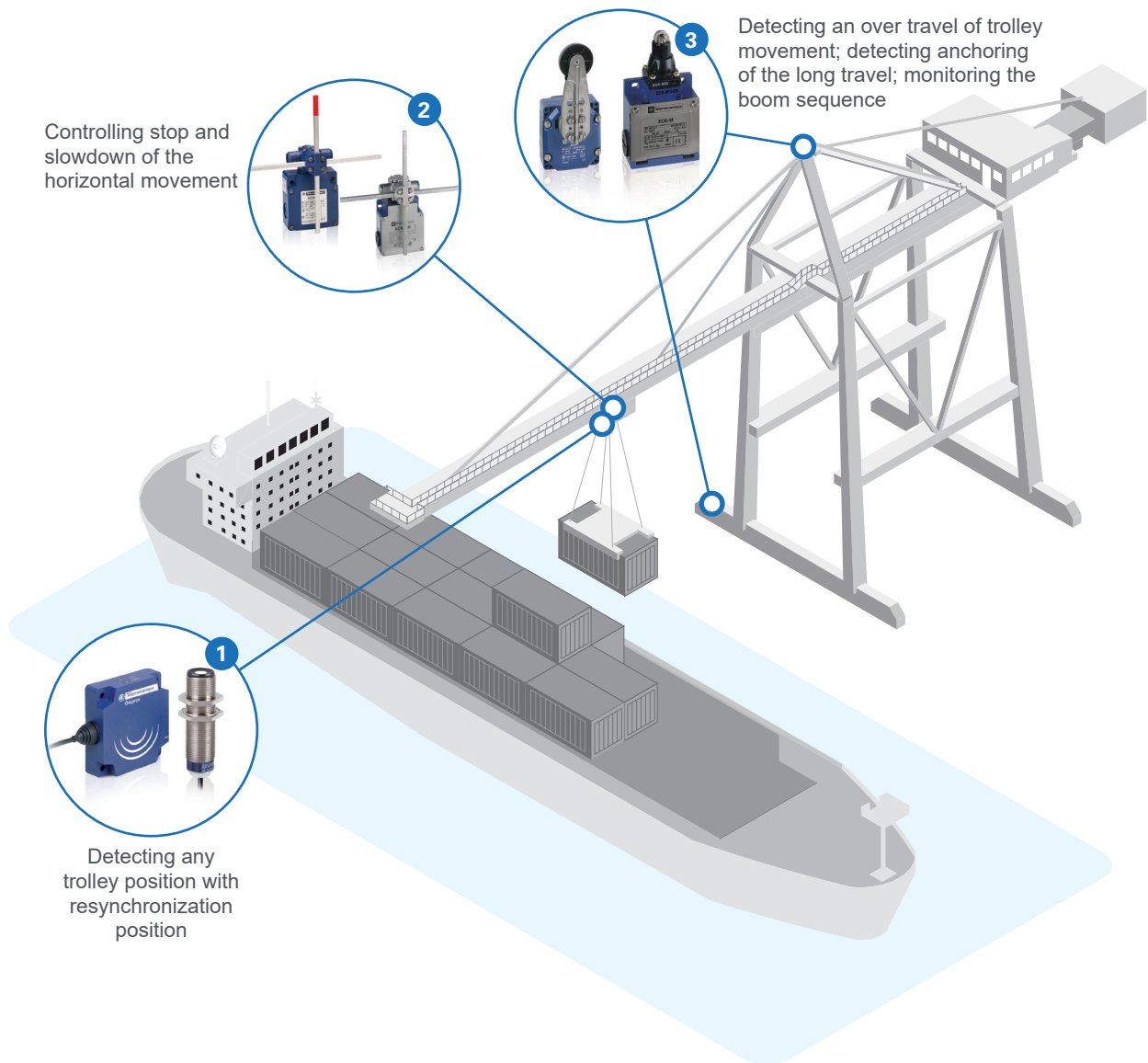

1 XS Inductive Sensor

Easy installation and adjustment.

2 XCKVR / XCKMR Limit Switches

2 ways / 2 speeds by one single sensor, compact and robust with positivity.













3 XCKM / XCR Limit Switches

Robust with positivity.



> Choose the best-suited product for your application

Limit switches

	Contact	Connection				
	XCKD Metal NO+NC Snap	M16	XCKD2110P16	XCKD2102P16	XCKD2118P16	
		Pg11	XCKD2110G11	XCKD2102G11	XCKD2118G11	
	XCMD Metal NO+NC Snap NO+NC Slow	cable	XCMD2110L1	XCMD2102L1	XCMD2115L1	
			XCMD2510L1	XCMD2502L1	XCMD2515L1	
	XCKM NO+NC Snap	M20	XCKM110H29	XCKM102H29	XCKM115H29	XCKM121H29
		Pg13	XCKM110	XCKM102	XCKM115	XCKM121
	XF9D 4 poles, 25A 4 poles, 65A	Pg21	XF9D251			
		Pg29	XF9D651			
	XF9F 3 poles, 115A 3 poles, 185A 3 poles, 265A	Pg36	XF9F1151*			
			XF9F1851*			
			XF9F2651*			
			* reset knob : replace the last 1 by 2 in the reference			
	XCKVR Plastic "By Pass" "Single Speed" "Double Speed"	M20x1.5	XCKVR24SR1H29			
			XCKVR44D1H29			
			XCKVR54SR1H29			
	XCKMR Metal "By Pass" "Single Speed" "Double Speed" "Double Speed"	M20x1.5	XCKMR24SR1H29			
			XCKMR44D1H29			
			XCKMR54D1H29			
		Pg13.5	XCKMR54D1			
	XCRA NO+NC Snap	Pg13.5	XCRA11	XCRA15		

Photoelectric sensors

XU						
Sensing distance			11 m	70 m	Recommended Reflector	Recommended Cable
AC/DC	Relay	Terminals	XUX9ARCTN16		XUJC100	XZCP29P12L10
24 V	PNP	M12 - 5 pins	XUX9APANM12		XUJC250	
		M12 - 8 pins	XUK9TAH2MM12		XUJC250	XZCP29P12L10

Inductive sensors



XS	Sensing distance		Ø 12 mm	Ø 18 mm	15x32x8 mm	26x26x13 mm	40x40x15 mm	
DC 3 wires NO	PNP	cable	4 mm	8 mm	5 mm	10 mm	15 mm	
		connector	XS112B3PAL2	XS118B3PAL2	XS7F1A1PAL2	XS7E1A1PAL2	XS7C1A1PAL2	
	NPN	cable	XS112B3PAM12	XS118B3PAM12	XS7F1A1PAL01M8	XS7E1A1PAM8	XS7C1A1PAM8	
		connector	XS112B3NAL2	XS118B3NAL2	XS7F1A1NAL2	XS7E1A1NAL2	XS7C1A1NAL2	
	DC 4 wires NO+NC	PNP	connector	XS112B3NAM12	XS118B3NAM12	XS7F1A1NAL01M8	XS7E1A1NAM8	XS7C1A1NAM8
			connector	XS112B3PCM12	XS118B3PCM12			

Pressure sensors

XMEP	Connector	Analogue output	0...60 bar	0...100 bar	0...250 bar	0...400 bar	0...600 bar
	M12	0,5-4, 5V	XMEP060BD11F	XMEP100BD11F	XMEP250BD11F	XMEP400BD11F	XMEP600BD11F
		4-20mA	XMEP060BD21F	XMEP100BD21F	XMEP250BD21F	XMEP400BD21F	XMEP600BD21F
		0-10V	XMEP060BD71F	XMEP100BD71F	XMEP250BD71F	XMEP400BD71F	XMEP600BD71F
	Deutsch DT04-3P	0,5-4, 5V	XMEP060BT11F	XMEP100BT11F	XMEP250BT11F	XMEP400BT11F	XMEP600BT11F
		4-20mA	XMEP060BT21F	XMEP100BT21F	XMEP250BT21F	XMEP400BT21F	XMEP600BT21F
		0-10V	XMEP060BT71F	XMEP100BT71F	XMEP250BT71F	XMEP400BT71F	XMEP600BT71F
	AMP Superseal 1,5 3-pin	0,5-4, 5V	XMEP060BV11F	XMEP100BV11F	XMEP250BV11F	XMEP400BV11F	XMEP600BV11F
		4-20mA	XMEP060BV21F	XMEP100BV21F	XMEP250BV21F	XMEP400BV21F	XMEP600BV21F
		0-10V	XMEP060BV71F	XMEP100BV71F	XMEP250BV71F	XMEP400BV71F	XMEP600BV71F
XMLR	Outputs		0...100 bar	0...160 bar	0...250 bar	0...400 bar	0...600 bar
	2 switching outputs		XMLR100M2P05	XMLR160M2P05	XMLR250M2P05	XMLR400M2P05	XMLR600M2P05
	Analogue 4...20mA + 1 switching output		XMLR100M1P05	XMLR160M1P05	XMLR250M1P05	XMLR400M1P05	XMLR600M1P05



Display for XMEP

PNP
2 switching outputs
ZMLPA2P0SH

PNP
Analogue 4...20mA
+ 1 switching output
ZMLPA2P0SH

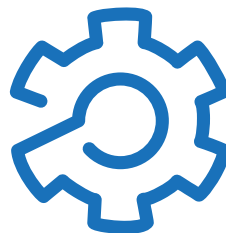

Robust and reliable

Discover our complete offer:
www.tesensors.com or
 contact your local sales agency

Schneider Electric Industries SAS

Head Office
 35, rue Joseph Monier – CS 30323
 F92506 Rueil-Malmaison Cedex
 FRANCE

www.tesensors.com

Due to the constant evolution of standards and equipment, the specifications indicated in the text and images of this document can only be guaranteed after confirmation by our departments. Print: Schneider Electric Photos: Schneider Electric

©2021 Schneider Electric. All Rights Reserved. Schneider Electric, OsiSense, and Telemecanique are trademarks and the property of Schneider Electric SE, its subsidiaries and affiliated companies. All other trademarks are the property of their respective owners.