

# High Operating Temperature Radial Leaded Multilayer Ceramic Capacitors for Automotive Applications, 50 V<sub>DC</sub>, 100 V<sub>DC</sub>, 200 V<sub>DC</sub>



## FEATURES

- AEC-Q200 qualified with PPAP available
- High reliability MLCC insert with wet build process
- High operating temperature up to 175 °C
- High capacitance with small size
- Radial mounting style
- Crimp and straight leadstyles
- Material categorization:  
for definitions of compliance please see [www.vishay.com/doc?99912](http://www.vishay.com/doc?99912)



## APPLICATIONS

- Automotive applications up to 175 °C

QUICK REFERENCE DATA						
DESCRIPTION	VALUE					
Ceramic Class	1			2		
Ceramic Dielectric	C0G			X0U		
Voltage (V <sub>DC</sub> )	50	100	200	50	100	200
Min. Capacitance (pF)	100	100	100	47 000	47 000	82 000
Max. Capacitance (pF)	12 000	12 000	8200	1 000 000	470 000	180 000
Mounting	Radial					

## MARKING

Marking indicates capacitance value and tolerance in accordance with “EIA 198”.

## OPERATING TEMPERATURE RANGE

-55 °C to +175 °C (voltage derating above 150 °C)

## TEMPERATURE CHARACTERISTICS

Class 1: C0G (± 30 ppm/K within -55 °C to +175 °C)  
Class 2: X0U (+22 % / -56 % within -55 °C to +175 °C)

## SECTIONAL SPECIFICATIONS

Climatic category (acc. to EN 60058-1)  
55/125/21

## APPROVALS

EIA 198  
IEC 60384-9  
AEC-Q200

## DESIGN

- The capacitors consist of a high reliability MLCC
- Leads wires are 0.5 mm or 0.6 mm and are made of 100 % tinned copper clad steel wire
- The capacitors may be supplied with straight or kinked leads having a lead spacing of 2.5 mm and 5.0 mm
- Coating is made of flame retardant epoxy resin in accordance with UL 94 V-0

## CAPACITANCE RANGE

100 pF to 1 μF

## TOLERANCE ON CAPACITANCE

± 5 %, ± 10 %, ± 20 %

## RATED VOLTAGE

50 V<sub>DC</sub>, 100 V<sub>DC</sub>, 200 V<sub>DC</sub>

## TEST VOLTAGE

- 50 V<sub>DC</sub> and 100 V<sub>DC</sub>: 250 % of rated voltage
- 200 V<sub>DC</sub>: 200 % of rated voltage

## INSULATION RESISTANCE

- 50 V<sub>DC</sub>, 100 V<sub>DC</sub>: 100 GΩ or 1000 ΩF whichever is less at rated voltage within 2 min of charging
- 200 V<sub>DC</sub>: 10 GΩ or 100 ΩF whichever is less at rated voltage within 2 min of charging

## DISSIPATION FACTOR

Class 1: 0.1 % max.  
(C ≤ 1000 pF, at 1 MHz, 1 V; C > 1000 pF, at 1 kHz, 1 V)  
Class 2: 2.5 % max. (at 1 kHz, 1 V)

**LEAD CONFIGURATION AND DIMENSIONS** in millimeters

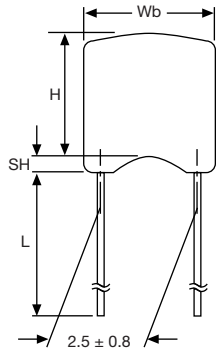

**L2**

Component outline for lead spacing 2.5 mm ± 0.5 mm (straight leads)

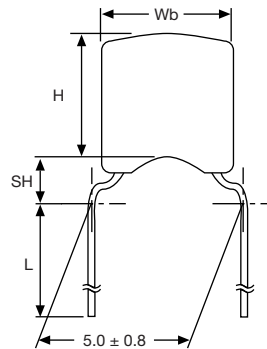

**H5**

Component outline for lead spacing 5.0 mm ± 0.5 mm (flat bent leads)

SIZE CODE	Wb <sub>MAX.</sub>	H <sub>MAX.</sub>	T <sub>MAX.</sub>	LEAD DIAMETER	MAXIMUM SEATING HEIGHT (SH)	
					L2	H5
15	3.0 - 3.8	2.0 - 3.8	1.6 - 2.6	0.50 ± 0.05	1.6	2.6
20	4.3 - 5.1	2.5 - 5.1	1.9 - 3.2	0.50 ± 0.05	1.6	2.6

**Notes**

- Bulk packed types have a standard lead length L = 30 mm ± 5 mm.
- L2 and H5 are preferred styles.

**MARKING** (two sides)

**SIZE 15 CAPACITANCE VALUE ≥ 100 pF**

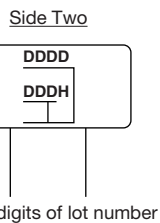
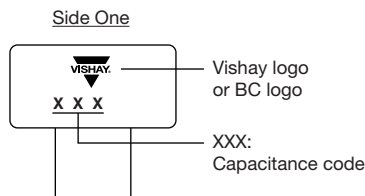

**SIZE 20**

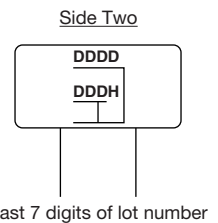
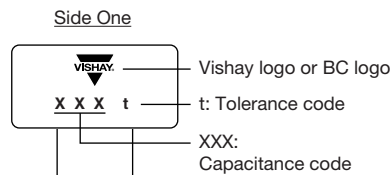

**Notes**

- Two significant digits followed by one digit for the multiplier: 1 = \* 10, 2 = \* 100, 3 = \* 1000, 4 = \* 10 000, 5 = \* 100 000.
- The tolerance codes are J = ± 5 %, K = ± 10 %, M = ± 20 %

**ORDERING CODE INFORMATION**

K	104	K	15	X0U	F	5	3	H	5	H
1	2 3 4	5	6 7	8 9 10	11	12	13	14	15	16
Product Type	Capacitance (pF)	Capacitance Tolerance	Size Code	T.C. Code	Rated Voltage	Lead Diameter	Packaging/Lead Length	Lead Style	Lead Spacing	AEC-Q200 qualified
K = Radial leaded MLCC	The first two digits are the significant figures of capacitance and the last digit is a multiplier as follows: 1 = * 10 2 = * 100 3 = * 1000 4 = * 10 000 5 = * 100 000	J = ± 5 % K = ± 10 % M = ± 20 %	Please refer to relevant datasheet	Please refer to relevant datasheet	F = 50 V <sub>DC</sub> H = 100 V <sub>DC</sub> K = 200 V <sub>DC</sub>	5 = 0.50 mm ± 0.05 mm 6 = 0.60 mm ± 0.05 mm	3 = Bulk T = Tape and reel U = Ammo	H = Flat crimp L = Straight K = Outside crimp	2 = 2.5 mm 5 = 5.0 mm	H = High operating temperature



ORDERING CODES

DIELECTRIC COG			
CAP. (pF)	50 V <sub>DC</sub>	100 V <sub>DC</sub>	200 V <sub>DC</sub>
100	K101#15C0GF5###H	K101#15C0GH5###H	K101#15C0GK5###H
120	K121#15C0GF5###H	K121#15C0GH5###H	K121#15C0GK5###H
150	K151#15C0GF5###H	K151#15C0GH5###H	K151#15C0GK5###H
180	K181#15C0GF5###H	K181#15C0GH5###H	K181#15C0GK5###H
220	K221#15C0GF5###H	K221#15C0GH5###H	K221#15C0GK5###H
270	K271#15C0GF5###H	K271#15C0GH5###H	K271#15C0GK5###H
330	K331#15C0GF5###H	K331#15C0GH5###H	K331#15C0GK5###H
390	K391#15C0GF5###H	K391#15C0GH5###H	K391#15C0GK5###H
470	K471#15C0GF5###H	K471#15C0GH5###H	K471#15C0GK5###H
560	K561#15C0GF5###H	K561#15C0GH5###H	K561#15C0GK5###H
680	K681#15C0GF5###H	K681#15C0GH5###H	K681#15C0GK5###H
820	K821#15C0GF5###H	K821#15C0GH5###H	K821#15C0GK5###H
1000	K102#15C0GF5###H	K102#15C0GH5###H	K102#15C0GK5###H
1200	K122#15C0GF5###H	K122#15C0GH5###H	K122#20C0GK6###H
1500	K152#15C0GF5###H	K152#15C0GH5###H	K152#20C0GK6###H
1800	K182#15C0GF5###H	K182#15C0GH5###H	K182#20C0GK6###H
2200	K222#15C0GF5###H	K222#20C0GH6###H	K222#20C0GK6###H
2700	K272#15C0GF5###H	K272#20C0GH6###H	K272#20C0GK6###H
3300	K332#15C0GF5###H	K332#20C0GH6###H	K332#20C0GK6###H
3900	K392#15C0GF5###H	K392#20C0GH6###H	K392#20C0GK6###H
4700	K472#20C0GF6###H	K472#20C0GH6###H	K472#20C0GK6###H
5600	K562#20C0GF6###H	K562#20C0GH6###H	K562#20C0GK6###H
6800	K682#20C0GF6###H	K682#20C0GH6###H	K682#20C0GK6###H
8200	K822#20C0GF6###H	K822#20C0GH6###H	K822#20C0GK6###H
10 000	K103#20C0GF6###H	K103#20C0GH6###H	/
12 000	K123#20C0GF6###H	K123#20C0GH6###H	/

DIELECTRIC XOU			
CAP. (pF)	50 V <sub>DC</sub>	100 V <sub>DC</sub>	200 V <sub>DC</sub>
47 000	K473#15X0UF5###H	K473#15X0UH5###H	/
56 000	K563#15X0UF5###H	K563#15X0UH5###H	/
68 000	K683#15X0UF5###H	K683#15X0UH5###H	/
82 000	K823#15X0UF5###H	K823#15X0UH5###H	K823#20X0UK6###H
100 000	K104#15X0UF5###H	K104#15X0UH5###H	K104#20X0UK6###H
120 000	K124#15X0UF5###H	K124#20X0UH6###H	K124#20X0UK6###H
150 000	K154#15X0UF5###H	K154#20X0UH6###H	K154#20X0UK6###H
180 000	K184#20X0UF6###H	K184#20X0UH6###H	K184#20X0UK6###H
220 000	K224#20X0UF6###H	K224#20X0UH6###H	/
270 000	K274#20X0UF6###H	K274#20X0UH6###H	/
330 000	K334#20X0UF6###H	K334#20X0UH6###H	/
390 000	K394#20X0UF6###H	K394#20X0UH6###H	/
470 000	K474#20X0UF6###H	K474#20X0UH6###H	/
560 000	K564#20X0UF6###H	/	/
680 000	K684#20X0UF6###H	/	/
820 000	K824#20X0UF6###H	/	/
1 000 000	K105#20X0UF6###H	/	/

Notes

- Lead diameter is 0.5 mm or 0.6 mm
- # 5th digit is capacitance tolerance code: ± 5 % = J; ± 10 % = K; ± 20 % = M
- # 13th digit is packaging code: Bulk = 3; Reel = T; Ammo = U
- # 14th digit is lead style code: L; H; K (L and H are preferred lead configuration)
- # 15th digit is lead spacing code: 2.5 mm = 2; 5.0 mm = 5



**RATED VOLTAGE VS. TEMPERATURE** (Typical)

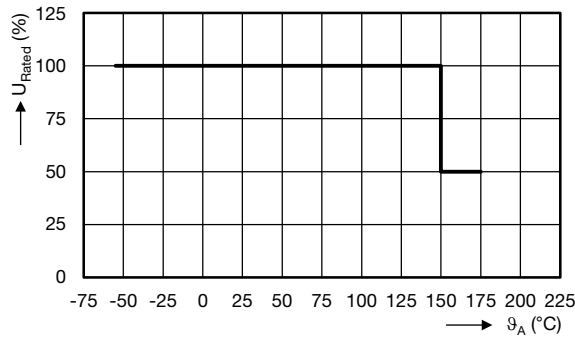

**CAPACITANCE CHANGE VS. TEMPERATURE** (Typical)

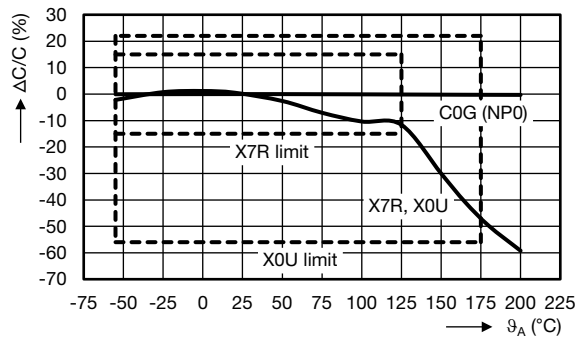

**DISSIPATION FACTOR VS. TEMPERATURE** (Typical)

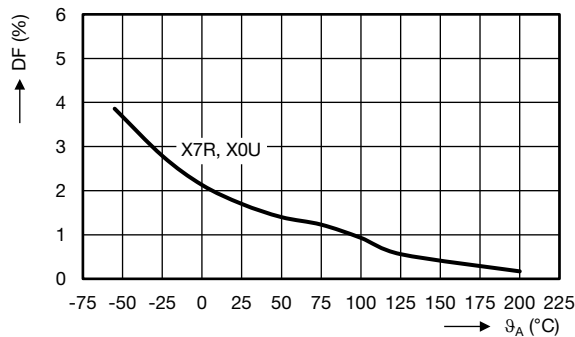

**INSULATION RESISTANCE VS. TEMPERATURE** (Typical)

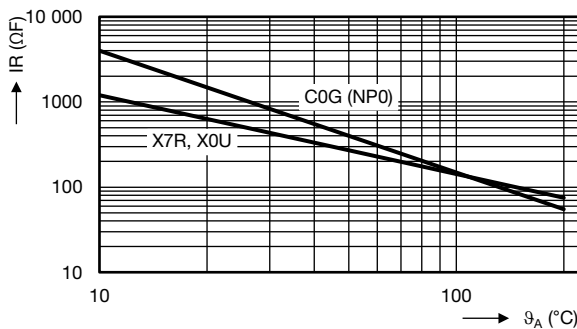

**TAPING AND PACKAGING**
**LABELLING**

Each reel is provided with a label showing the following details:

Manufacturer, K style, capacitance, tolerance, batch number, quantity of components, rated voltage, dielectric.

On special request other designations can be shown.

For example:

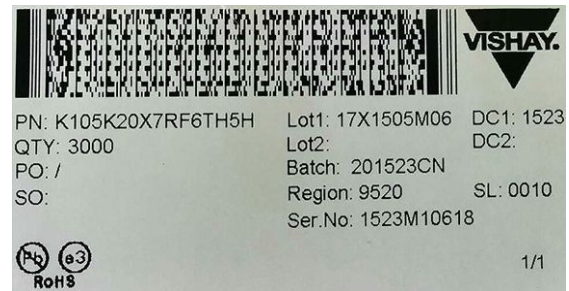

PACKAGING QUANTITIES AND BOX DIMENSIONS			
PACKAGING	SIZE CODE	SMALLEST PACKAGING QUANTITY (SPQ)	BOX DIMENSIONS L x W x H (mm)
Tape on reel	15	4000	370 x 370 x 60
	20	3000	
Ammopack	15, 20	2500	335 x 290 x 50
Bulk <sup>(1)</sup>	15, 20	5000	245 x 120 x 65

**Note**

<sup>(1)</sup> SPQ contains one or a multiple of poly-bags, 1000 units per bag.

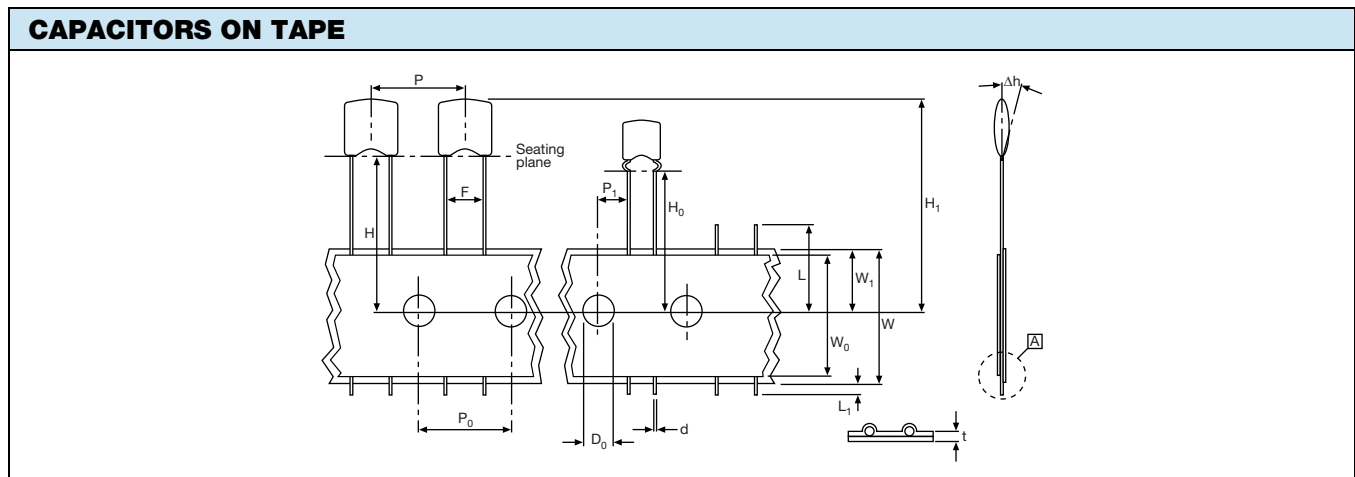

PARAMETER	SYMBOL	DIMENSIONS	
		mm	INCH
Cut-off length	L	≤ 11	≤ 0.443
Lead end protrusion	L <sub>1</sub>	≤ 1	≤ 0.039
Height to seating plane (straight leads)	H	≥ 18	≥ 0.709
Height to seating plane (crimp leads)	H <sub>0</sub>	16.0 ± 0.5	0.630 ± 0.020
Top of component height	H <sub>1</sub>	≤ 32	≤ 1.26
Body inclination	Δh	0 ± 1.0	0 ± 0.039
Carrier tape width	W	18.0 +1.0/-0.5	0.709 +0.039/-0.020
Hold down tape width	W <sub>0</sub>	15.0 REF.	0.591 REF.
Sprocket hole position	W <sub>1</sub>	9.00 +0.075/-0.50	0.354 +0.030/-0.020
Lead space	F	2.50 +0.60/-0.40	0.100 +0.024/-0.016
		5.00 +0.60/-0.40	0.200 +0.024/-0.016
Sprocket hole pitch	P <sub>0</sub>	12.70 ± 0.30	0.500 ± 0.012
Sprocket hole center to lead center at F = 2.5 mm	P <sub>1</sub>	5.08 ± 0.70	0.200 ± 0.028
Sprocket hole center to lead center at F = 5 mm		3.85 ± 0.70	0.150 ± 0.028
Sprocket hole diameter	D <sub>0</sub>	4.0 ± 0.30	0.157 ± 0.012
Overall tape thickness	t	≤ 0.90	≤ 0.035
Wire lead diameter	d	0.50 ± 0.05	0.020 ± 0.002
Taping pitch	P	12.7 REF.	0.50 REF.

**REEL DATA**

A maximum of 0.5 % of the total number of capacitors per reel may be missing.

A maximum of 1 consecutive vacant positions is followed by 6 consecutive components.

Tape begins and ends with a minimum of 4 empty positions (50 mm tape).

Maximum of 5 splicers per reel.

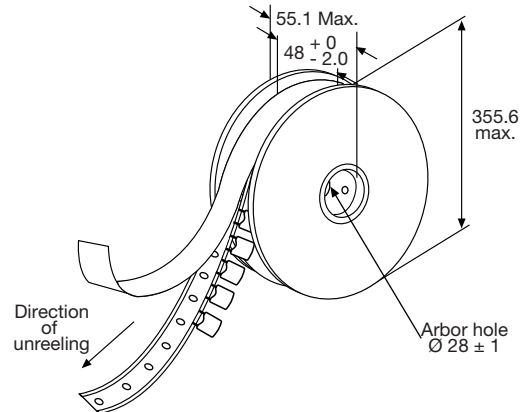
**REEL**

REEL DIMENSIONS		
REEL SIZE		(mm)
A	Outer diameter	355.6 max.
L	Hole diameter	28 ± 1
K	Core diameter	90
H <sub>1</sub>	Internal width	48 +0/-2
H <sub>2</sub>	External width	55 max.

**AMMOPACK DATA**

A maximum of 0.5 % of the total number of capacitors per pack may be missing.

A maximum of 1 consecutive vacant positions is followed by 6 consecutive components.

Tape begins and ends with a minimum of 4 empty positions (50 mm tape).

Maximum of 5 splicers per pack.

The cumulative pitch tolerance over 20 consecutive units is not to exceed ± 1.0 mm.

Lead space (F) shall be measured at 3.6 mm ± 0.5 mm from the capacitor seating plane.

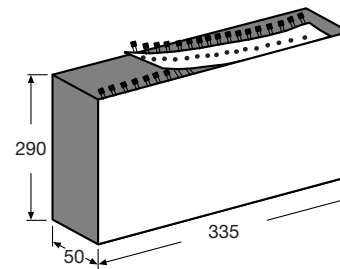
**AMMOPACK**

RELATED DOCUMENTS	
General Information	<a href="http://www.vishay.com/doc?45214">www.vishay.com/doc?45214</a>

SAMPLE KIT	
Part Number	HOTC-KIT-KH
Link	<a href="http://www.vishay.com/doc?45234">www.vishay.com/doc?45234</a>