

# Network cable - NBC-M12MSX/ 2,0-94F/R4RC



1407476

<https://www.phoenixcontact.com/gb/products/1407476>

Please be informed that the data shown in this PDF document is generated from our Online Catalog. Please find the complete data in the user documentation. Our General Terms of Use for Downloads are valid.



Network cable, Ethernet CAT6<sub>A</sub> (10 Gbps), CC-Link IE CAT6<sub>A</sub> (10 Gbps), 8-position halogen-free, shielded (Advanced Shielding Technology), Plug straight M12 SPEEDCON / IP67, coding: X, on Plug straight RJ45 Push Pull / IP67, cable length: 2 m

## Commercial Data

Item number	1407476
Packing unit	1 pc
Minimum order quantity	1 pc
Sales Key	BF1CMJ
Product Key	BF1CMJ
Catalog Page	Page 403 (C-2-2019)
GTIN	4046356776752
Weight per Piece (including packing)	174.7 g
Weight per Piece (excluding packing)	94.68 g
Customs tariff number	85444210
Country of origin	PL

# Network cable - NBC-M12MSX/ 2,0-94F/R4RC



1407476

<https://www.phoenixcontact.com/gb/products/1407476>

## Technical Data

### Notes

General	Further products with variable cable type and variable cable length can be found in the accessories section
---------	---

### Product properties

Product type	Data cable preassembled
Number of positions	8
Application	Standard
No. of cable outlets	1
Number of slots	1
Shielded	yes
Coding	X - data

### Interfaces

Bus system	Ethernet
Signal type/category	Ethernet CAT6 <sub>A</sub> , 10 Gbps
	CC-Link IE CAT6 <sub>A</sub> , 10 Gbps
	Ethernet CAT6 <sub>A</sub> , 10 Gbps
	CC-Link IE CAT6 <sub>A</sub> , 10 Gbps

### LED signaling

Status display	No
Status display present	No

### Electrical properties

Nominal voltage $U_N$	48 V AC
	60 V DC
Nominal current $I_N$	0.5 A
Transmission medium	Copper

### Material specifications

Color Handle area	gray / black
Material of grip body	TPU, hardly inflammable, self-extinguishing
Contact material	CuSn
Contact surface material	Ni/Au
Contact carrier material	PA
Cable gland material	Zinc die-cast, nickel-plated
Housing material	Plastic

### Connector

#### Header 1

Type	Plug straight M12 SPEEDCON / IP67
------	-----------------------------------

# Network cable - NBC-M12MSX/ 2,0-94F/R4RC



1407476

<https://www.phoenixcontact.com/gb/products/1407476>

Number of positions	8
Coding type	X (Data)
Handle color	black
Material	CuZn (Contact)
	Ni/Au (Contact surface)
	PP (Contact carriers)
	TPU, hardly inflammable, self-extinguishing (Grip)
	Zinc die-cast, nickel-plated (Screw connection)
Insertion/withdrawal cycles	≥ 100
Contact resistance	≤ 5 mΩ
Insulation resistance	≥ 100 MΩ
Tightening torque	0.4 Nm
Degree of protection	IP67
Ambient temperature (operation)	-25 °C ... 90 °C

## Head 2

Type	Plug straight RJ45 Push Pull / IP67
Number of positions	8 (8)
Handle color	silver
Material	CuSn (Contact)
	Ni/Au (Contact surface)
	PC (Contact carriers)
	Zinc die-cast, nickel-plated (Housing)
Insertion/withdrawal cycles	≥ 750
Ambient temperature (operation)	-40 °C ... 70 °C

## Cable / line

Cable length	2 m
Cable weight	42 kg/km
UL AWM Style	20963 (80°C/30 V)
Number of positions	8
Shielded	yes
Cable type	Ethernet 10 Gbit [94F]
Signal runtime	5.13 ns/m
Conductor structure signal line	7x 0.16 mm
AWG signal line	26
Conductor cross section	4x 2x 0.14 mm <sup>2</sup>
Wire diameter incl. insulation	1.04 mm
External cable diameter	6.4 mm ±0.2 mm
Outer sheath, material	PUR
External sheath, color	water blue RAL 5021
Conductor material	Bare Cu litz wires
Material wire insulation	Foamed PE
Single wire, color	white/blue-blue, white/orange-orange, white/green-green, white/brown-brown

# Network cable - NBC-M12MSX/ 2,0-94F/R4RC



1407476

<https://www.phoenixcontact.com/gb/products/1407476>

Thickness, outer sheath	0.65 mm
Twisted pairs	2 cores to the pair
Type of pair shielding	Aluminum-lined foil
Overall twist	4 pairs for core
Optical shield covering	70 %
Insulation resistance	≥ 500 MΩ*km
Loop resistance	≤ 290.00 Ω/km
Wave impedance	100 Ω ±5 Ω (at 100 MHz)
Cable capacity	47 nF/km
Nominal voltage, cable	≤ 100 V
Test voltage Core/Core	700 V (50 Hz, 1 min.)
Test voltage Core/Shield	700 V (50 Hz, 1 min.)
Minimum bending radius, fixed installation	4 x D
Minimum bending radius, flexible installation	8 x D
Tensile strength	≤ 100 N
Near end crosstalk attenuation (NEXT)	75.3 dB (with 1 MHz)
	66.3 dB (at 4 MHz)
	61.8 dB (at 8 MHz)
	60.3 dB (at 10 MHz)
	57.2 dB (at 16 MHz)
	55.8 dB (at 20 MHz)
	54.3 dB (at 25 MHz)
	52.8 dB (at 31.25 MHz)
	48.4 dB (at 62.5 MHz)
	45.3 dB (at 100 MHz)
	40.8 dB (at 200 MHz)
	39.3 dB (at 250 MHz)
	38.1 dB (at 300 MHz)
	36.3 dB (at 400 MHz)
34.8 dB (at 500 MHz)	
Power-summated near end crosstalk attenuation (PSNEXT)	72.3 dB (with 1 MHz)
	63.3 dB (at 4 MHz)
	58.8 dB (at 8 MHz)
	57.3 dB (at 10 MHz)
	54.2 dB (at 16 MHz)
	52.8 dB (at 20 MHz)
	51.3 dB (at 25 MHz)
	49.9 dB (at 31.25 MHz)
	45.4 dB (at 62.5 MHz)
	42.3 dB (at 100 MHz)
	37.8 dB (at 200 MHz)
	36.3 dB (at 250 MHz)
	35.1 dB (at 300 MHz)
	33.3 dB (at 400 MHz)

# Network cable - NBC-M12MSX/ 2,0-94F/R4RC



1407476

<https://www.phoenixcontact.com/gb/products/1407476>

Return loss (RL)	31.8 dB (at 500 MHz)
	20 dB (with 1 MHz)
	23 dB (at 4 MHz)
	24.5 dB (at 8 MHz)
	25 dB (at 10 MHz)
	25 dB (at 16 MHz)
	25 dB (at 20 MHz)
	24.2 dB (at 25 MHz)
	23.3 dB (at 31.25 MHz)
	20.7 dB (at 62.5 MHz)
	19 dB (at 100 MHz)
	16.4 dB (at 200 MHz)
	15.6 dB (at 250 MHz)
	15.6 dB (at 300 MHz)
	15.6 dB (at 400 MHz)
15.6 dB (at 500 MHz)	
Shield attenuation	3.1 dB (with 1 MHz)
	5.7 dB (at 4 MHz)
	8 dB (at 8 MHz)
	8.9 dB (at 10 MHz)
	11.2 dB (at 16 MHz)
	12.6 dB (at 20 MHz)
	14.1 dB (at 25 MHz)
	15.8 dB (at 31.25 MHz)
	22.5 dB (at 62.5 MHz)
	28.7 dB (at 100 MHz)
	41.4 dB (at 200 MHz)
	46.6 dB (at 250 MHz)
	51.4 dB (at 300 MHz)
	60.1 dB (at 400 MHz)
	67.9 dB (at 500 MHz)
≥ 80 dB (at 30 ... 100 MHz)	
Halogen-free	according to IEC 60754-1
Flame resistance	according to IEC 60332-1-2
Resistance to oil	in accordance with DIN EN 60811-2-1
Ambient temperature (operation)	-40 °C ... 80 °C (cable, fixed installation)
	-20 °C ... 80 °C (Cable, flexible installation)
Ambient temperature (installation)	-20 °C ... 80 °C
Cable structure	
Signal type/category	Ethernet CAT6 <sub>A</sub> , 10 Gbps
	CC-Link IE CAT6 <sub>A</sub> , 10 Gbps

## Ambient conditions

# Network cable - NBC-M12MSX/ 2,0-94F/R4RC



1407476

<https://www.phoenixcontact.com/gb/products/1407476>

Degree of protection	IP65 (M12 connector)
	IP67 (M12 connector)
	IP67 (RJ45 connector)
Degree of protection	IP65/IP67
Ambient temperature (operation)	-25 °C ... 90 °C (M12 connector)
	-40 °C ... 70 °C (RJ45 connector)

## Standards and regulations

M12

Standards/specifications	IEC 61076-2-109
--------------------------	-----------------

1407476

<https://www.phoenixcontact.com/gb/products/1407476>

## Drawings

Dimensional drawing

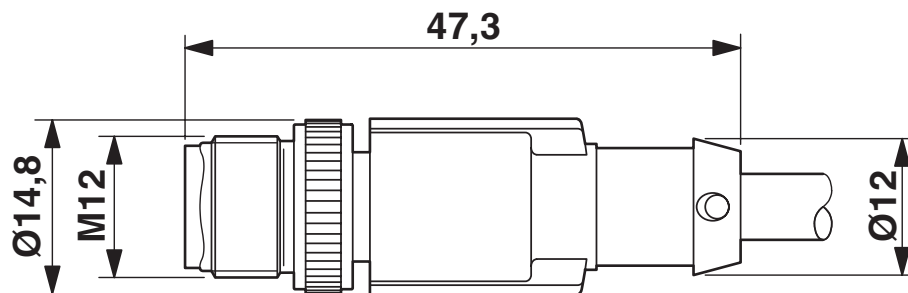

Plug, M12 x 1, straight, shielded

Circuit diagram

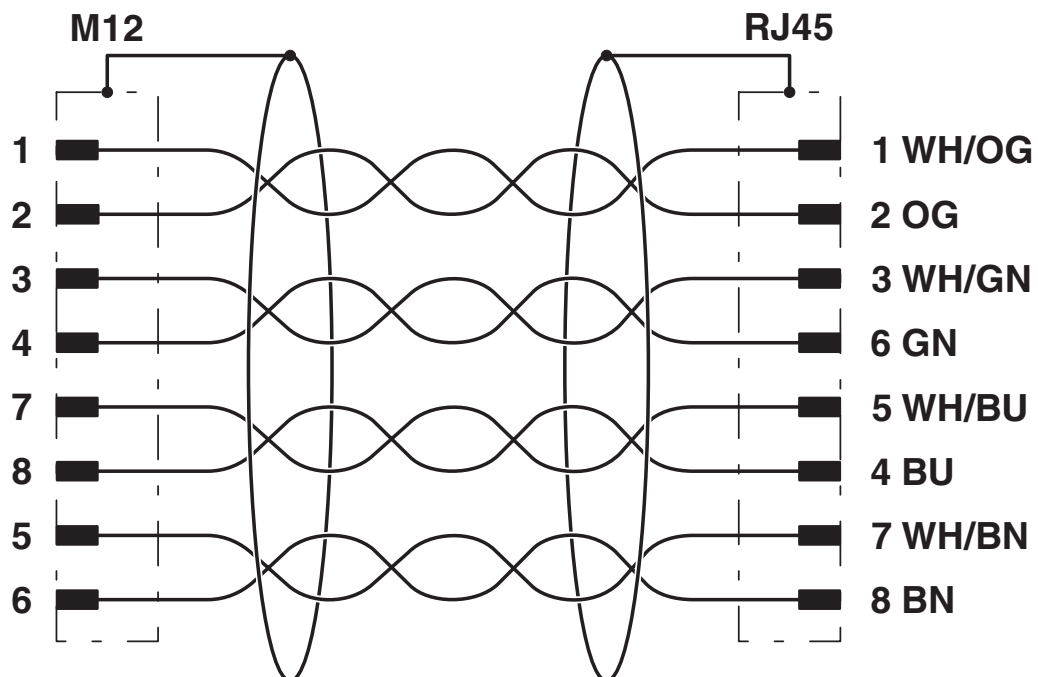

Contact assignment of the M12 and RJ45 plug

# Network cable - NBC-M12MSX/ 2,0-94F/R4RC

1407476

<https://www.phoenixcontact.com/gb/products/1407476>



Schematic diagram

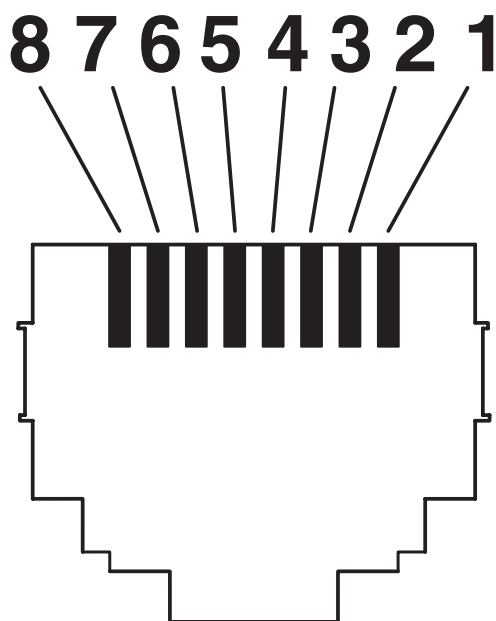

Connector pin assignment plug RJ45



# Network cable - NBC-M12MSX/ 2,0-94F/R4RC

1407476

<https://www.phoenixcontact.com/gb/products/1407476>



Dimensional drawing

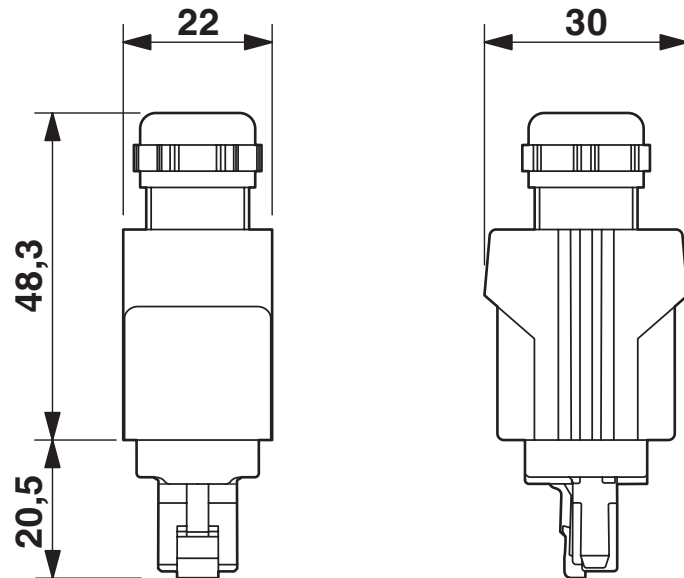

RJ45 Push-Pull connector, IP67

Schematic diagram

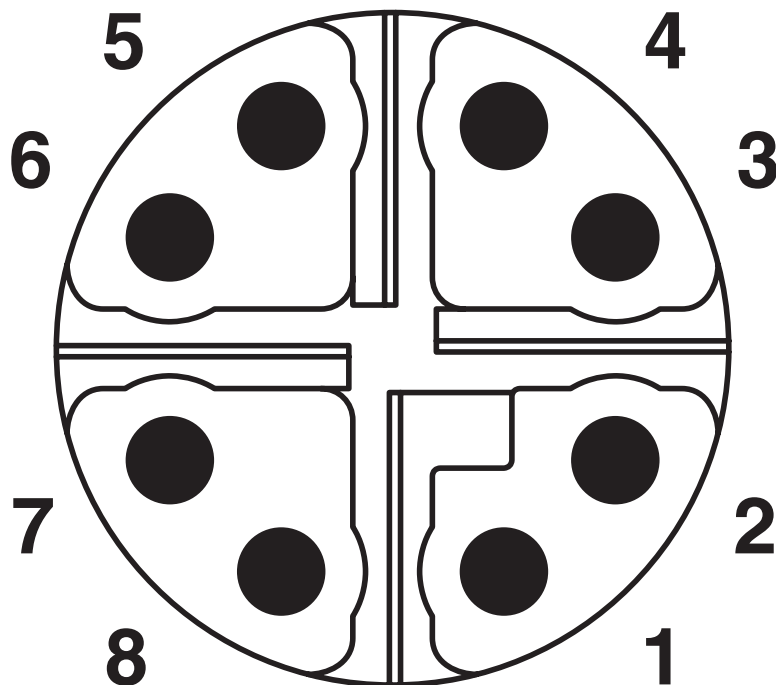

Pin assignment of M12 plug, 8-pos., X-coded, pin side view

# Network cable - NBC-M12MSX/ 2,0-94F/R4RC





1407476

<https://www.phoenixcontact.com/gb/products/1407476>

## Approvals

 <b>UL Listed</b> Approval ID: FILE E 335024				
	Nominal Voltage $U_N$	Nominal Current $I_N$	Cross Section AWG	Cross Section $\text{mm}^2$
	30 V	0.5 A	-	-

 <b>cUL Listed</b> Approval ID: FILE E 335024				
	Nominal Voltage $U_N$	Nominal Current $I_N$	Cross Section AWG	Cross Section $\text{mm}^2$
	30 V	0.5 A	-	-

 <b>EAC</b> Approval ID: RU D-DE.HB35.B.00387				
---	--	--	--	--

<b>cULus Listed</b>				
---------------------	--	--	--	--

# Network cable - NBC-M12MSX/ 2,0-94F/R4RC



1407476

<https://www.phoenixcontact.com/gb/products/1407476>

## Classifications

### ECLASS

ECLASS-9.0	27060308
ECLASS-10.0.1	27060308
ECLASS-11.0	27060307

### ETIM

ETIM 8.0	EC001855
----------	----------

### UNSPSC

UNSPSC 21.0	26121600
-------------	----------

# Network cable - NBC-M12MSX/ 2,0-94F/R4RC



1407476

<https://www.phoenixcontact.com/gb/products/1407476>

## Environmental Product Compliance

REACH SVHC	Lead 7439-92-1
China RoHS	Environmentally friendly use period: unlimited = EFUP-e
	No hazardous substances above threshold values

# Network cable - NBC-M12MSX/ 2,0-94F/R4RC



1407476

<https://www.phoenixcontact.com/gb/products/1407476>

## Accessories

### Network cable

Network cable - NBC-M12MSX-R4RC-10G/.../... - 1408646

<https://www.phoenixcontact.com/gb/products/1408646>



Network cable, Ethernet CAT6<sub>A</sub> (10 Gbps), CC-Link IE CAT6<sub>A</sub> (10 Gbps), 8-position, Variable cable type, shielded (Advanced Shielding Technology), Plug straight M12 / IP67, coding: X, on Plug straight RJ45 Push Pull / IP67, cable length: Free input (0.2 ... 40.0 m)

---

### Torque screwdriver

Torque screwdriver - TSD 04 SAC - 1208429

<https://www.phoenixcontact.com/gb/products/1208429>



Torque screwdriver, with preset torque of 0.4 Nm and 4 mm hexagonal drive for M12 connectors

# Network cable - NBC-M12MSX/ 2,0-94F/R4RC

1407476

<https://www.phoenixcontact.com/gb/products/1407476>

## Network cable

Network cable - NBC-M12MSX-R4QC-10G/.../... - 1408645

<https://www.phoenixcontact.com/gb/products/1408645>



Network cable, Ethernet CAT6<sub>A</sub> (10 Gbps), CC-Link IE CAT6<sub>A</sub> (10 Gbps), 8-position, Variable cable type, shielded (Advanced Shielding Technology), Plug straight M12 / IP67, coding: X, on Plug straight RJ45 Push Pull / IP67, cable length: Free input (0.2 ... 40.0 m)

---

## Torque screwdriver

Torque screwdriver - TSD-M 1,2NM - 1212224

<https://www.phoenixcontact.com/gb/products/1212224>



Torque screw driver, accuracy as per EN ISO 6789 standard, adjustable from 0.3 - 1.2 Nm

# Network cable - NBC-M12MSX/ 2,0-94F/R4RC



1407476

<https://www.phoenixcontact.com/gb/products/1407476>

## Adapter insert

Adapter insert - TSD-M SAC-BIT ADAPTER - 1212600

<https://www.phoenixcontact.com/gb/products/1212600>



Adapter bit for TSD-M...torque tools, E6.3-1/4" drive with 4 mm hexagon to accommodate SAC bits

---

## Tool

Tool - SAC BIT M12-D15 - 1208432

<https://www.phoenixcontact.com/gb/products/1208432>



Nut for assembling sensor/actuator cables with M12 connector and M12 connectors for assembly, with a knurl diameter of 15 mm, for 4 mm hexagonal drive

# Network cable - NBC-M12MSX/ 2,0-94F/R4RC



1407476

<https://www.phoenixcontact.com/gb/products/1407476>

## Sealing cap

Sealing cap - PROT-M12 FS-PA-CHAIN - 1430873

<https://www.phoenixcontact.com/gb/products/1430873>

M12 sealing cap made of plastic with fixing band, for sensor cables, for free M12 plugs



---

## Locking clip

Locking clip - SAC-M12-EXCLIP-M - 1558988

<https://www.phoenixcontact.com/gb/products/1558988>

Locking clip for the pin side of sensor/actuator cables with M12 connector and M12 connectors for assembly, for knurl diameter: 15 mm or for Allen key with a wrench size of 14 mm, prevents the disconnection of plug-in connections without tools





# Network cable - NBC-M12MSX/ 2,0-94F/R4RC



1407476

<https://www.phoenixcontact.com/gb/products/1407476>

## Cable-cutting tool

Cable-cutting tool - CUTFOX 12 - 1212128

<https://www.phoenixcontact.com/gb/products/1212128>



**Cable cutter**, for copper and aluminum up to 12 mm diameter (up to 35 mm<sup>2</sup>)

---

## Diagonal cutter

Diagonal cutter - CUTFOX-S VDE - 1212207

<https://www.phoenixcontact.com/gb/products/1212207>



Diagonal cutter for hard (piano wire) and soft wires, VDE 1000 V AC/1500 V DC tested

# Network cable - NBC-M12MSX/ 2,0-94F/R4RC

1407476

<https://www.phoenixcontact.com/gb/products/1407476>

## Stripping tool

Stripping tool - VS-CABLE-STRIP-VARIO - 1657407

<https://www.phoenixcontact.com/gb/products/1657407>

Stripping tool, for the multi-level stripping of shielded cables



---

## Diagonal cutter

Diagonal cutter - MICROFOX-SP-1 - 1212487

<https://www.phoenixcontact.com/gb/products/1212487>

Electronic diagonal cutter, tapered head, without chamfer, with opening spring, non-reflective phosphate-treated surface, punched version



# Network cable - NBC-M12MSX/ 2,0-94F/R4RC



1407476

<https://www.phoenixcontact.com/gb/products/1407476>

## Stripping tool

Stripping tool - WIREFOX 4 - 1212156

<https://www.phoenixcontact.com/gb/products/1212156>



Stripping tool, for cables and conductors (especially for rubber and silicone insulations) from 0.1 - 4 mm<sup>2</sup>, self-adjusting, stripping length of up to 18 mm, cutting capacity of up to 10 mm<sup>2</sup> stranded/1.5 mm<sup>2</sup> solid, replaceable stripping blade

---

## Stripping tool

Stripping tool - WIREFOX-E 4 - 1212704

<https://www.phoenixcontact.com/gb/products/1212704>



Stripping tool, for cables and conductors (especially for rubber and silicone insulations) from 0.1 - 4 mm<sup>2</sup>, self-adjusting, stripping length of up to 18 mm, cutting capacity of up to 10 mm<sup>2</sup> stranded/1.5 mm<sup>2</sup> solid, replaceable stripping blade

# Network cable - NBC-M12MSX/ 2,0-94F/R4RC



1407476

<https://www.phoenixcontact.com/gb/products/1407476>

## Stripping tool

Stripping tool - WIREFOX 10 - 1212150

<https://www.phoenixcontact.com/gb/products/1212150>



Stripping tool, for cables and conductors from 0.02 - 10 mm<sup>2</sup>, self-adjusting, stripping length of up to 18 mm, cutting capacity of up to 10 mm<sup>2</sup> stranded/1.5 mm<sup>2</sup> solid, replaceable stripping blade

---

## Protective hose adapter

Protective hose adapter - WP-CTA POM 13,0 BK - 1422884

<https://www.phoenixcontact.com/gb/products/1422884>



Protective hose adapter, for corrugated hoses with a nominal size of 13 (10 x 13), corrugated in parallel

# Network cable - NBC-M12MSX/ 2,0-94F/R4RC

1407476

<https://www.phoenixcontact.com/gb/products/1407476>

## Protective hose

Protective hose - WP-PA HF 13,0 BK - 3240681

<https://www.phoenixcontact.com/gb/products/3240681>



Protective hose, material: PA 6, filament: without, UV-resistant: yes, flexible, degree of protection: IP68, color: black, inflammability class in acc. with UL 94: V0, inner diameter: 10 mm, Total length: 50 m

---

## Protective hose

Protective hose - WP-PA HF-HB 13,0 BK - 3240839

<https://www.phoenixcontact.com/gb/products/3240839>



Protective hose, material: PA 6, filament: without, UV-resistant: yes, flexible, degree of protection: IP68, color: black, inflammability class in acc. with UL 94: HB, inner diameter: 10 mm, Total length: 50 m

# Network cable - NBC-M12MSX/ 2,0-94F/R4RC

1407476

<https://www.phoenixcontact.com/gb/products/1407476>

## Data connector

Data connector - SACC-M12MSX-8QO SH ETH - 1411043

<https://www.phoenixcontact.com/gb/products/1411043>



Data connector, Ethernet CAT6<sub>A</sub> (10 Gbps), 8-position, halogen-free, shielded, Plug straight M12 SPEEDCON, Coding: X, Insulation displacement connection, knurl material: Zinc die-cast, nickel-plated, external cable diameter 5 mm ... 9.7 mm

---

## Data connector

Data connector - SACC-M12FSX-8QO SH ETH - 1414586

<https://www.phoenixcontact.com/gb/products/1414586>



Data connector, Ethernet CAT6<sub>A</sub> (10 Gbps), 8-position, halogen-free, shielded, Socket straight M12 SPEEDCON, Coding: X, Insulation displacement connection, knurl material: Zinc die-cast, nickel-plated, external cable diameter 5 mm ... 9.7 mm

# Network cable - NBC-M12MSX/ 2,0-94F/R4RC

1407476

<https://www.phoenixcontact.com/gb/products/1407476>

## Conductor connectors

Conductor connectors - SACC-CC-8QO SH ETH - 1414412

<https://www.phoenixcontact.com/gb/products/1414412>



Cable connector, Ethernet CAT6<sub>A</sub> (10 Gbps), 8-pos., halogen-free, shielded, insulation displacement connection, housing material: zinc die-cast, nickel-plated, outer cable diameter of 5 mm ... 9.7 mm

---

## Data connector

Data connector - VS-08-M12MS-10G-P SCO - 1417430

<https://www.phoenixcontact.com/gb/products/1417430>



Data connector, Ethernet CAT6<sub>A</sub> (10 Gbps), 8-position, shielded, Plug straight M12 SPEEDCON, Coding: X, Piercecon<sup>®</sup>, knurl material: Zinc die-cast, nickel-plated, external cable diameter 4 mm ... 8 mm

# Network cable - NBC-M12MSX/ 2,0-94F/R4RC



1407476

<https://www.phoenixcontact.com/gb/products/1407476>

## Data connector

Data connector - VS-08-M12MR-10G-P SCO - 1417443

<https://www.phoenixcontact.com/gb/products/1417443>



Data connector, Ethernet CAT6<sub>A</sub> (10 Gbps), 8-position, shielded, Plug angled M12 SPEEDCON, Coding: X, Piercecon<sup>®</sup>, knurl material: Zinc die-cast, nickel-plated, external cable diameter 4 mm ... 8 mm

---

## Data connector

Data connector - SACC-M12MSX-8CT-CL SH - 1422844

<https://www.phoenixcontact.com/gb/products/1422844>



Data connector, Ethernet CAT6<sub>A</sub> (10 Gbps), PROFINET CAT6<sub>A</sub> (10 Gbps), 8-position, shielded, Plug straight M12, Coding: X, Crimp connection, knurl material: Zinc die-cast, tin-plated, external cable diameter 6.5 mm ... 10 mm, without crimp contacts



# Network cable - NBC-M12MSX/ 2,0-94F/R4RC



1407476

<https://www.phoenixcontact.com/gb/products/1407476>

## Data connector

Data connector - SACC-M12MRX-8CT-CL SH - 1422845

<https://www.phoenixcontact.com/gb/products/1422845>



Data connector, Ethernet CAT6<sub>A</sub> (10 Gbps), PROFINET CAT6<sub>A</sub> (10 Gbps), 8-position, shielded, Plug angled M12, Coding: X, Crimp connection, knurl material: Zinc die-cast, tin-plated, external cable diameter 6.5 mm ... 10 mm, without crimp contacts

---

## RJ45 connector

RJ45 connector - VS-08-RJ45-10G/Q - 1419001

<https://www.phoenixcontact.com/gb/products/1419001>



RJ45 connector, IP20, CAT6<sub>A</sub>, 8-pos., with QUICKON fast connection technology, for 26 ... 24 AWG 1-wire and 7-wire conductors, color: black

# Network cable - NBC-M12MSX/ 2,0-94F/R4RC

1407476

<https://www.phoenixcontact.com/gb/products/1407476>

## RJ45 connector

RJ45 connector - CUC-IND-C1ZNI-S/R4IE8 - 1421607

<https://www.phoenixcontact.com/gb/products/1421607>



RJ45 connector, type: RJ45, degree of protection: IP20, number of positions: 8, 1 Gbps, CAT5 (IEC 11801:2002), material: Zinc die-cast, connection method: IDC fast connection, connection cross section: AWG 26- 24, cable outlet: straight, color: green, Ethernet

---

## RJ45 connector

RJ45 connector - CUC-IND-C1ZNI-T/R4IE8 - 1421877

<https://www.phoenixcontact.com/gb/products/1421877>



RJ45 connector, type: RJ45, degree of protection: IP20, number of positions: 8, 1 Gbps, CAT5 (IEC 11801:2002), material: Zinc die-cast, connection method: IDC fast connection, connection cross section: AWG 26- 24, cable outlet: angled, Ethernet

# Network cable - NBC-M12MSX/ 2,0-94F/R4RC



1407476

<https://www.phoenixcontact.com/gb/products/1407476>

## RJ45 connector

RJ45 connector - CUC-IND-C1ZNI-B/R4IE8 - 1421876

<https://www.phoenixcontact.com/gb/products/1421876>



RJ45 connector, type: RJ45, degree of protection: IP20, number of positions: 8, 1 Gbps, CAT5 (IEC 11801:2002), material: Zinc die-cast, connection method: IDC fast connection, connection cross section: AWG 26- 24, cable outlet: angled, Ethernet

---

## RJ45 connector

RJ45 connector - CUC-V06-C1PGY-S/R4CEA:1 - 1414406

<https://www.phoenixcontact.com/gb/products/1414406>



RJ45 connector, type: RJ45, degree of protection: IP67, 10 Gbps, CAT6<sub>A</sub>, material: PA, connection method: Crimp connection, connection cross section: AWG 24- 27, cable outlet: straight, color: gray, Ethernet/PROFINET

# Network cable - NBC-M12MSX/ 2,0-94F/R4RC



1407476

<https://www.phoenixcontact.com/gb/products/1407476>

## RJ45 connector

RJ45 connector - CUC-V06-C1PBK-S/R4CEA:1 - 1414410

<https://www.phoenixcontact.com/gb/products/1414410>



RJ45 connector, type: RJ45, degree of protection: IP67, number of positions: 8, 10 Gbps, CAT6<sub>A</sub>, material: PA, connection method: Crimp connection, connection cross section: AWG 24- 27, cable outlet: straight, color: black, Ethernet/PROFINET

## RJ45 connector

RJ45 connector - VS-PPC-C1-RJ45-POBK-8I10G - 1422205

<https://www.phoenixcontact.com/gb/products/1422205>



RJ45 connector, IP67, with push/pull interlocking (Version 14), plastic housing, for 10 Gbps, for 24 ... 27 AWG stranded conductors

Phoenix Contact 2022 © - all rights reserved  
<https://www.phoenixcontact.com>

PHOENIX CONTACT Ltd  
Halesfield 13, Telford  
Shropshire, TF7 4PG  
01952 681700  
[info@phoenixcontact.co.uk](mailto:info@phoenixcontact.co.uk)