



ATV Series™



18 Position Heavy Duty Connectors

The ATV Series™ connectors further expands the proven reliability of the AT Series™ with a compact 18 position sealed flange design. The durable thermoplastic housings feature built-in contact sealing to eliminate individual wire-sealing grommets, while an integral interfacial seal protects mated connectors. The ATV Series™ is perfectly suited to on and off highway applications, marine, industrial, and agriculture markets in harsh environments.

Key Features

- 18 Position cavity arrangement
- Rectangular, thermoplastic housing
- Accepts contact size 16 (13A)
- 14-22AWG
- Flange Mount or In-line (Flangeless) Capability
- Integrated latch for mating
- Integrated wedgelock confirms contact alignment/retention
- Available in custom color options



| | |
|------------------------------|---|
| Housings | Thermoplastic |
| Seals | Silicone Elastomer |
| Secondary Locks | Thermoplastic |
| Contacts | Copper Alloy, Nickel Plated, Gold optional |
| Temperature | Operating temperature range: -55°C to +125°C at rated current |
| Dielectric Value | Meets or exceeds 1500 volts minimum |
| Drop Test | Shall not become detached or loosened when placed at 750mm and dropped to concrete eight times. |
| Shock | No latch disengagement or discontinuity shall be the result when subjected to 50 g's in each of three axis (X, Y & Z) |
| Vibration | Continued continuity without degradation to mechanical or physical attributes following vibration. (max acceleration 20 g's at Sine sweep of 10-2000Hz) |
| Connector Terminal Retention | When subjected to a direct pull, contacts achieve a minimum pull-out force of 25 lbs. |
| Connector Retention | A mated connector subjected to a pulling force by the exiting wire bundle at 25 lbs. times the number of contacts to a maximum of 100 lbs. applying load for 30 seconds |
| Thermal Shock | Subjected to 10 cycles at -55°C to +125°C with no cracking, chipping or other damage detrimental to the normal operation of the connector |
| Insulation Resistance | 1000 megohms minimum at 25°C |
| Mating Cycle Durability | Following 100 cycles of connection engagement and disengagement, degradation either mechanical or electrical is not evident |
| Contact Millivolt Drop | Size 16 contacts with 16AWG conductor - 100 mV drop max at 13A test current |
| Water Immersion | IP67-rated in mated condition |







A Series™ Family

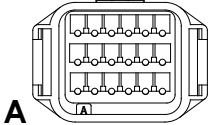

Standard products. Custom solutions
Customer Service +1 800 394 7732

ATV Series™ Heavy Duty Connectors

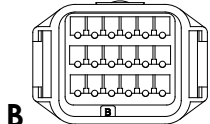
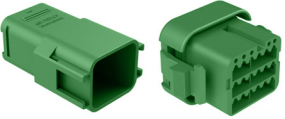
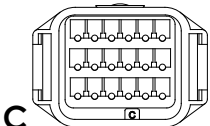
| Image | Part Number | Description |
|---|--|--|
|  | ATV02-18PA | 18 Pos., Flange Mount Receptacle, Size 16 Contact, Key A, Grey |
| | ATV02-18PA-RR01 | 18 Pos., Flange Mount Receptacle, Size 16 Contact, Key A, Double Reduced Seal, Grey |
| | ATV02-18PB | 18 Pos., Flange Mount Receptacle, Size 16 Contact, Key B, Black |
| | ATV02-18PB-RR01 | 18 Pos., Flange Mount Receptacle, Size 16 Contact, Key B, Double Reduced Seal, Black |
| | ATV02-18PC | 18 Pos., Flange Mount Receptacle, Size 16 Contact, Key C, Green |
| | ATV02-18PC-RR01 | 18 Pos., Flange Mount Receptacle, Size 16 Contact, Key C, Double Reduced Seal, Green |
| | ATV02-18PD | 18 Pos., Flange Mount Receptacle, Size 16 Contact, Key D, Brown |
| ATV02-18PD-RR01 | 18 Pos., Flange Mount Receptacle, Size 16 Contact, Key D, Double Reduced Seal, Brown | |
|  | ATV04-18PA | 18 Pos., In-Line Receptacle, Size 16 Contact, Key A, Grey |
| | ATV04-18PA-RR01 | 18 Pos., In-Line Receptacle, Size 16 Contact, Key A, Double Reduced Seal, Grey |
| | ATV04-18PB | 18 Pos., In-Line Receptacle, Size 16 Contact, Key B, Black |
| | ATV04-18PB-RR01 | 18 Pos., In-Line Receptacle, Size 16 Contact, Key B, Double Reduced Seal, Black |
| | ATV04-18PC | 18 Pos., In-Line Receptacle, Size 16 Contact, Key C, Green |
| | ATV04-18PC-RR01 | 18 Pos., In-Line Receptacle, Size 16 Contact, Key C, Double Reduced Seal, Green |
| | ATV04-18PD | 18 Pos., In-Line Receptacle, Size 16 Contact, Key D, Brown |
| ATV04-18PD-RR01 | 18 Pos., In-Line Receptacle, Size 16 Contact, Key D, Double Reduced Seal, Brown | |
|  | ATV06-18SA | 18 Pos., Plug, Size 16 Contact, Key A, Standard Seal, Grey |
| | ATV06-18SA-RR01 | 18 Pos., Plug, Size 16 Contact, Key A, Double Reduced Seal, Grey |
| | ATV06-18SB | 18 Pos., Plug, Size 16 Contact, Key B, Standard Seal, Black |
| | ATV06-18SB-RR01 | 18 Pos., Plug, Size 16 Contact, Key B, Double Reduced Seal, Black |
| | ATV06-18SC | 18 Pos., Plug, Size 16 Contact, Key C, Standard Seal, Green |
| | ATV06-18SC-RR01 | 18 Pos., Plug, Size 16 Contact, Key C, Double Reduced Seal, Green |
| | ATV06-18SD | 18 Pos., Plug, Size 16 Contact, Key D, Standard Seal, Brown |
| ATV06-18SD-RR01 | 18 Pos., Plug, Size 16 Contact, Key D, Double Reduced Seal, Brown | |
|  | AWV-18P | Wedgelock For 18 Pos., ATV Receptacle, Green |
| | AWV-18S | Wedgelock For 18 Pos., ATV Plug, Green |

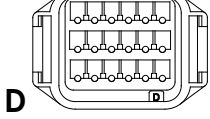
| Image | Keying Option A, B, C, D |
|--|---|
|  |  |
|  |  |
|  |  |
|  |  |

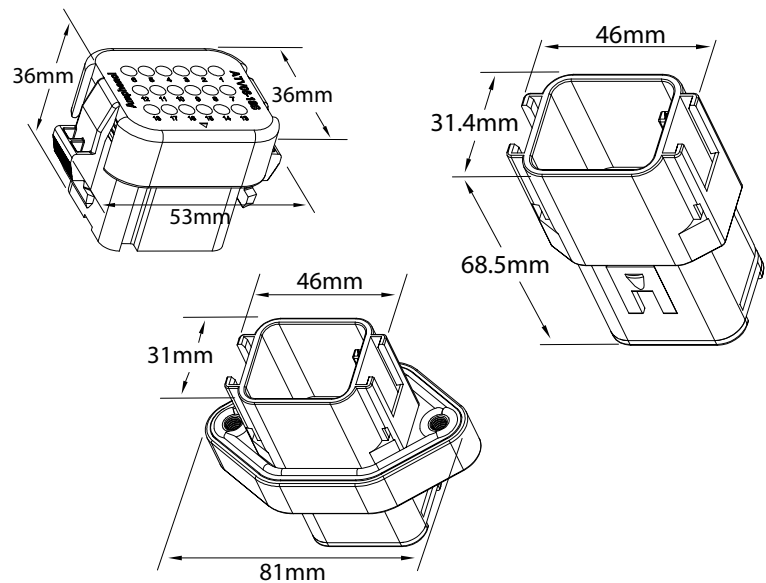

For more information, contact: Customer Service, +1 800 394 7732, csr@amphenol-sine.com