

Indicator lights, 22 mm, round, plastic, amber, lens, smooth



Product brand name	SIRIUS ACT
Product designation	Indicator lights
Design of the product	Actuating/signaling element
Product type designation	3SU1

### Actuator

Color	
<ul style="list-style-type: none"> <li>of the actuating element</li> </ul>	amber
Material of the actuating element	plastic
Shape of the actuating element	round
Outer diameter of the actuating element	29.45 mm

### Front ring

Product component front ring	No
------------------------------	----

### General technical data

Protection class IP	IP66, IP67, IP69(IP69K)
Degree of protection NEMA rating	NEMA 1, 2, 3, 3R, 4, 4X, 12, 13
Shock resistance	
<ul style="list-style-type: none"> <li>acc. to IEC 60068-2-27</li> </ul>	Sinusoidal half-wave 50 g / 11 ms
<ul style="list-style-type: none"> <li>for railway applications acc. to DIN EN 61373</li> </ul>	Category 1, Class B

Reference code acc. to DIN EN 81346-2	P
Reference code acc. to DIN EN 61346-2	P

### Connections/Terminals

Tightening torque of the screws in the bracket	1 ... 1.2 N·m
--	---------------





### Ambient conditions

<b>Ambient temperature</b>	
<ul style="list-style-type: none"> <li>during operation</li> <li>during storage</li> </ul>	<p>-25 ... +70 °C</p> <p>-40 ... +80 °C</p>
Environmental category during operation acc. to IEC 60721	3M6, 3S2, 3B2, 3C3, 3K6 (with relative air humidity of 10 ... 95 %)

### Installation/ mounting/ dimensions

Height	29.5 mm
Width	29.5 mm
Shape of the installation opening	round
Mounting diameter	22.3 mm
Positive tolerance of installation diameter	0.4 mm
Mounting height	11.8 mm
Installation width	29.5 mm
Installation depth	24.4 mm

### Certificates/approvals

General Product Approval	Declaration of Conformity	Test Certificates
 CSA	 UL	 EAC
	 EG-Konf.	<a href="#">Miscellaneous</a>
		<a href="#">Special Test Certificate</a>

### Test Certificates

Test Certificates	Marine / Shipping
<a href="#">Type Test Certificates/Test Report</a>	 ABS  LRS  PRS  RINA  RMRS

### Marine / Shipping

Marine / Shipping	other
 DNV-GL DNVGL.COM/AF	<a href="#">Confirmation</a>

## Further information

### Information- and Downloadcenter (Catalogs, Brochures,...)

<http://www.siemens.com/industrial-controls/catalogs>

### Industry Mall (Online ordering system)

<https://mall.industry.siemens.com/mall/en/en/Catalog/product?mfb=3SU1001-6AA00-0AA0>

### Cax online generator

<http://support.automation.siemens.com/WW/CAXorder/default.aspx?lang=en&mfb=3SU1001-6AA00-0AA0>

### Service&Support (Manuals, Certificates, Characteristics, FAQs,...)

<https://support.industry.siemens.com/cs/ww/en/ps/3SU1001-6AA00-0AA0>

### Image database (product images, 2D dimension drawings, 3D models, device circuit diagrams, EPLAN macros, ...)

[http://www.automation.siemens.com/bilddb/cax\\_de.aspx?mfb=3SU1001-6AA00-0AA0&lang=en](http://www.automation.siemens.com/bilddb/cax_de.aspx?mfb=3SU1001-6AA00-0AA0&lang=en)

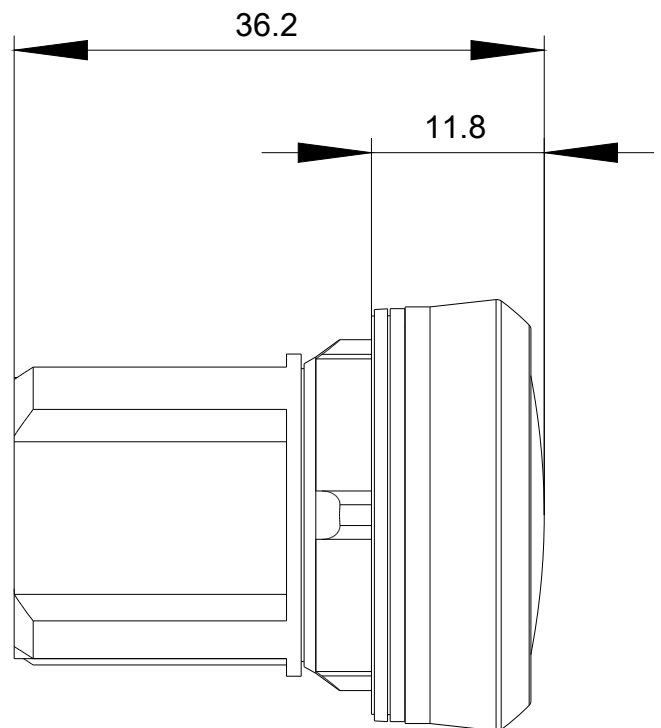
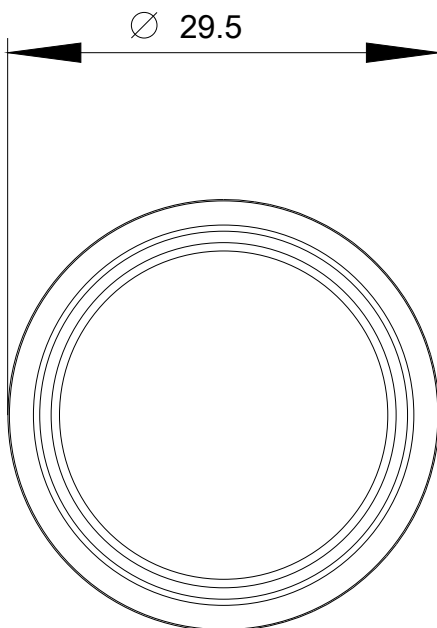

last modified:

09/12/2019