



Our *passion* is enclosures.



technoBOX

Standard enclosures made of ABS

Technical data

technoBOX



External hinges



Fancy external mounting feet,
90° rotating

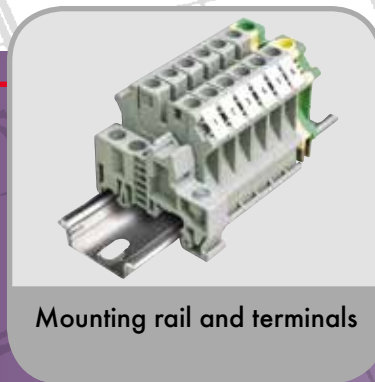

Mounting rail and terminals



Alternative design due to
slanted lid edges



Mounting plate

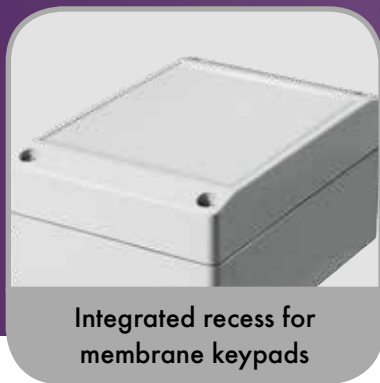

Integrated recess for
membrane keypads



Front plate

Enclosure: Thermoplastic ABS, halogen-free, 1° mould slope for casting ejection, internal measures diminishing circulatory towards enclosure bottom by 1°.

Flammability: UL 94 HB

Integrated recess: In the lid for membrane keypad or front plates

Components: Fastening dome for self-tapping screws in the lower and upper section.

Ingress protection: IP66 / EN 60529

Gasket: Chloroprene (CR), gasket (-30°C to +90°C)

Lid screws: Stainless steel 1.4567 (V2A), captive

Surface: RAL 7035, light grey

Optionally available:

Gasket: EMC gasket (-55°C to +160°C)

EMC screen: Aluminium coating 2.5µm

Surface: Special material on request

Further options, see delivery overview.

Delivery overview technoBOX

Type	Mat.-Nr.	L	W	H	D	E	g	M*	T	F*	A	S	EMV
TBA 060	220.060.000	66	51	35	53	38	50	○	●	○	●	○	●
TBA 080	220.080.000	83	81	60	70	50	170	●	●	●	●	●	●
TBA 082	220.082.000	121	81	60	108	50	220	●	●	●	●	●	●
TBA 084	220.084.000	161	81	60	148	50	220	●	●	●	●	●	●
TBA 102	220.102.000	151	101	60	138	70	230	●	●	●	●	●	●
TBA 104	220.104.000	201	101	60	188	70	300	●	●	●	●	●	●
TBA 120	220.120.000	123	121	80	110	90	240	●	●	●	●	●	●
TBA 122	220.122.000	201	121	80	188	90	400	●	●	●	●	●	●
TBA 160	220.160.000	161	161	80	148	130	450	●	●	●	●	●	●
TBA 162	220.162.000	241	161	80	228	130	650	●	●	●	●	●	●

* On request

□ Standard ● Available ○ Not available

Approvals:

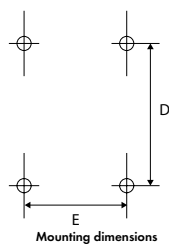
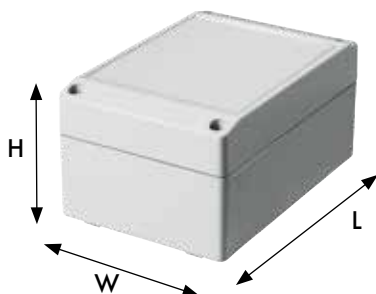

ROLEC Attachment and mounting dimensions

technoBOX

TBA 060

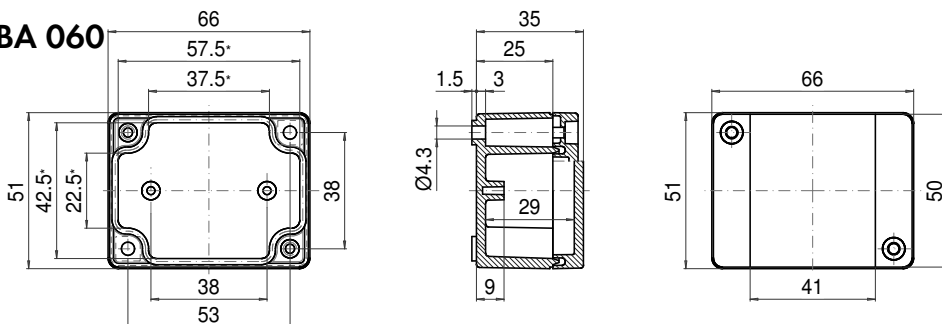

* Please note: Mould slope for casting ejection, dimensions in the amount of the bottom!

Maximum number of cable glands per enclosure side

A		A/B	C/D
C	D		
M 16	PG 7	2	1
	PG 9	2	1
	PG 11		
M 20	PG 13,5		
	PG 16		
M 25	PG 21		
M 32	PG 29		
M 40	PG 36		
M 50	PG 42		
M 63	PG 48		

TBA 080

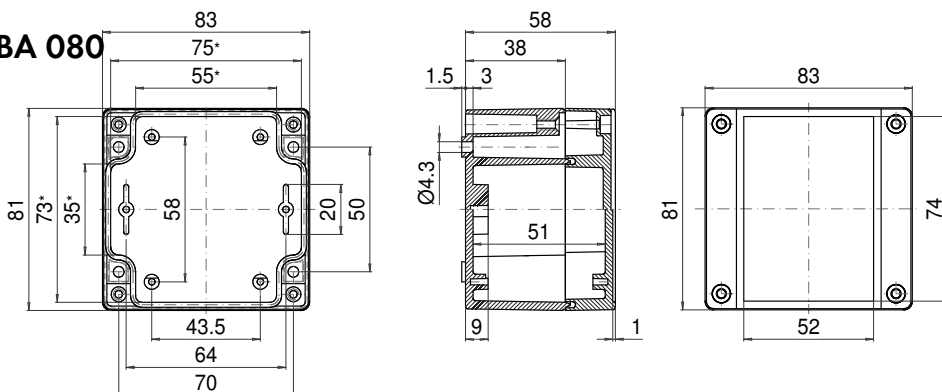

* Please note: Mould slope for casting ejection, dimensions in the amount of the bottom!

Maximum number of cable glands per enclosure side

A		A/B	C/D
C	D		
M 16	PG 7	4	2
	PG 9	3	1
	PG 11	2	1
M 20	PG 13,5	2	1
	PG 16	2	1
M 25	PG 21		
M 32	PG 29		
M 40	PG 36		
M 50	PG 42		
M 63	PG 48		

TBA 082

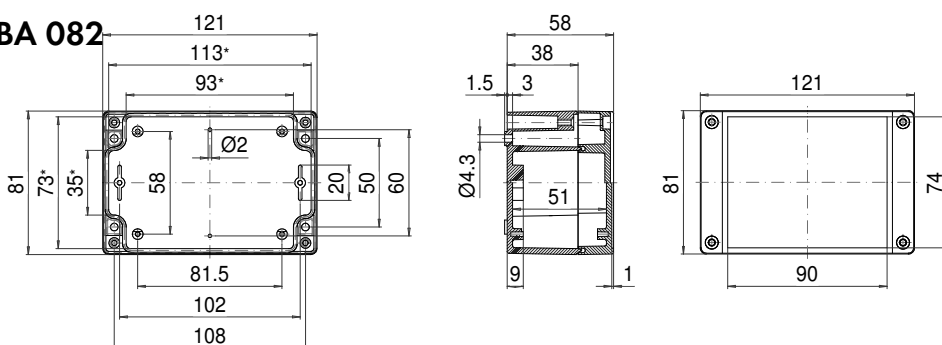

* Please note: Mould slope for casting ejection, dimensions in the amount of the bottom!

Maximum number of cable glands per enclosure side

A		A/B	C/D
C	D		
M 16	PG 7	8	3
	PG 9	5	2
	PG 11	4	1
M 20	PG 13,5	3	1
	PG 16	3	1
M 25	PG 21		
M 32	PG 29		
M 40	PG 36		
M 50	PG 42		
M 63	PG 48		

TBA 084

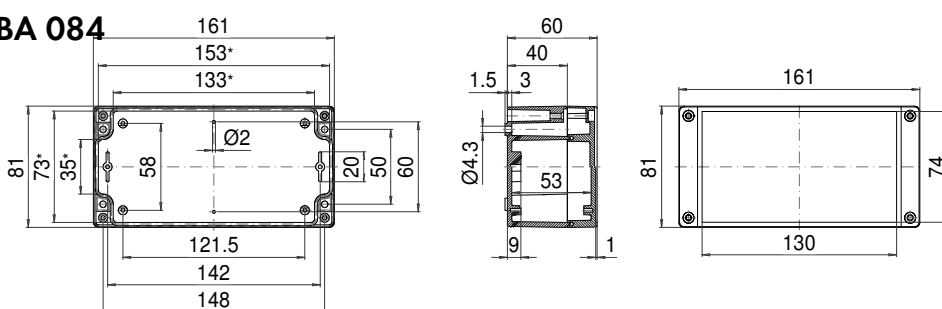

* Please note: Mould slope for casting ejection, dimensions in the amount of the bottom!

Maximum number of cable glands per enclosure side

A		A/B	C/D
C	D		
M 16	PG 7	13	3
	PG 9	8	2
	PG 11	6	1
M 20	PG 13,5	5	1
	PG 16	4	1
M 25	PG 21		
M 32	PG 29		
M 40	PG 36		
M 50	PG 42		
M 63	PG 48		

TBA 102

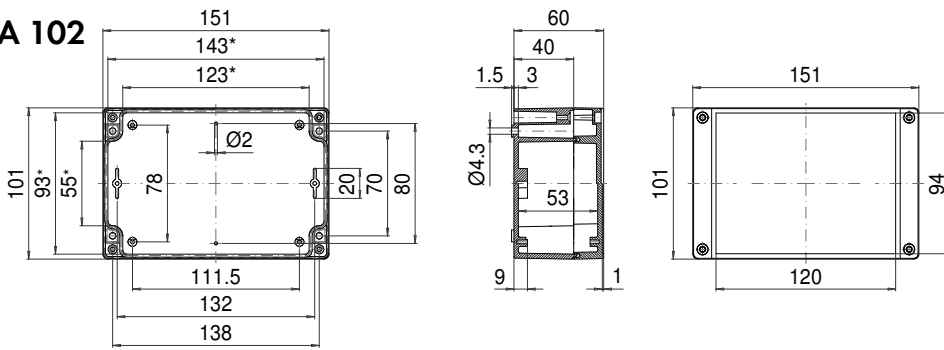

* Please note: Mould slope for casting ejection, dimensions in the amount of the bottom!

Maximum number of cable glands per enclosure side

A		A/B/C/D	
C	D	A	B/C/D
	B	PG 7	16 6
M 16		PG 9	8 4
		PG 11	7 3
M 20		PG 13,5	5 2
		PG 16	3 1
M 25		PG 21	3 1
M 32		PG 29	
M 40		PG 36	
M 50		PG 42	
M 63		PG 48	

TBA 104

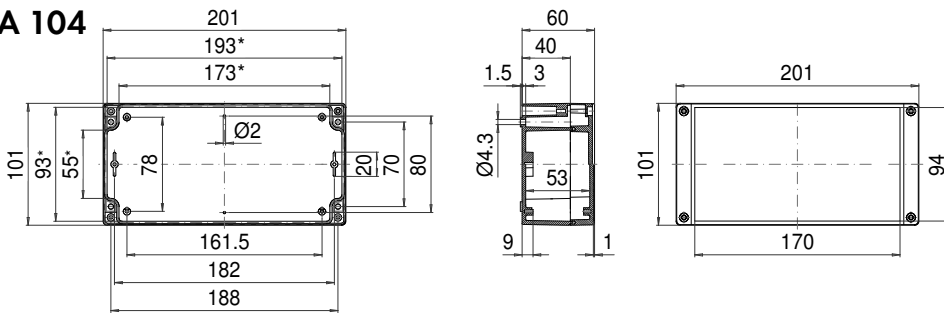

* Please note: Mould slope for casting ejection, dimensions in the amount of the bottom!

Maximum number of cable glands per enclosure side

A		A/B/C/D	
C	D	A	B/C/D
	B	PG 7	23 6
M 16		PG 9	12 4
		PG 11	9 3
M 20		PG 13,5	7 2
		PG 16	5 1
M 25		PG 21	4 1
M 32		PG 29	
M 40		PG 36	
M 50		PG 42	
M 63		PG 48	

TBA 120

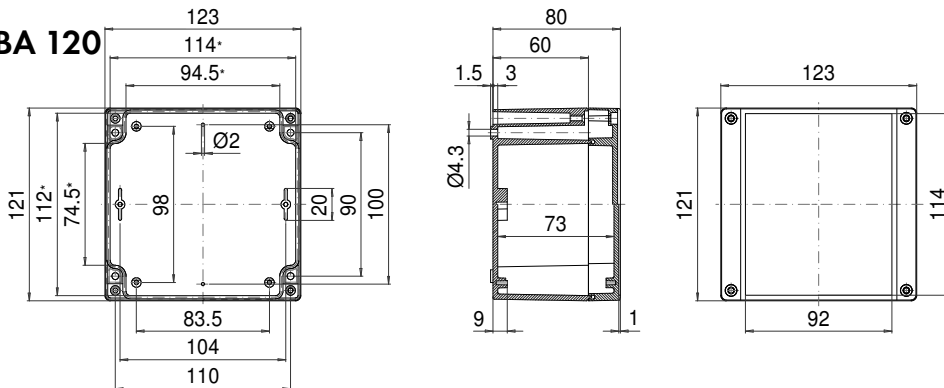

* Please note: Mould slope for casting ejection, dimensions in the amount of the bottom!

Maximum number of cable glands per enclosure side

A		A/B/C/D	
C	D	A	B/C/D
	B	PG 7	15 12
M 16		PG 9	10 9
		PG 11	8 6
M 20		PG 13,5	6 6
		PG 16	6 4
M 25		PG 21	4 3
M 32		PG 29	2 1
M 40		PG 36	1 1
M 50		PG 42	
M 63		PG 48	

TBA 122

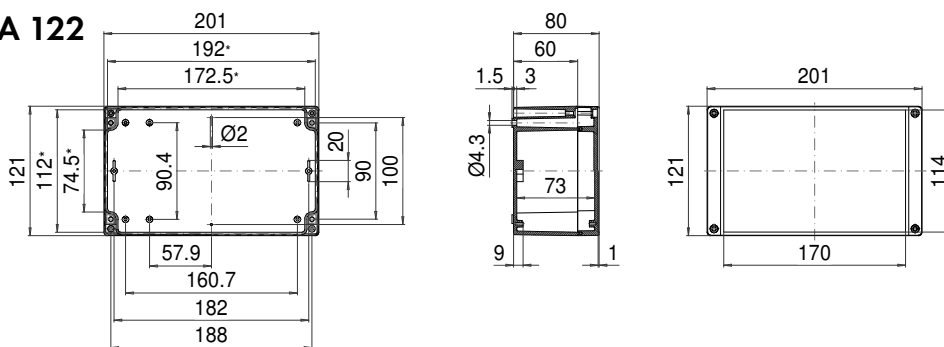

* Please note: Mould slope for casting ejection, dimensions in the amount of the bottom!

Maximum number of cable glands per enclosure side

A		A/B/C/D	
C	D	A	B/C/D
	B	PG 7	20 8
M 16		PG 9	16 6
		PG 11	12 4
M 20		PG 13,5	12 4
		PG 16	7 3
M 25		PG 21	4 2
M 32		PG 29	3 1
M 40		PG 36	
M 50		PG 42	
M 63		PG 48	

ROLEC Attachment and mounting dimensions

technoBOX

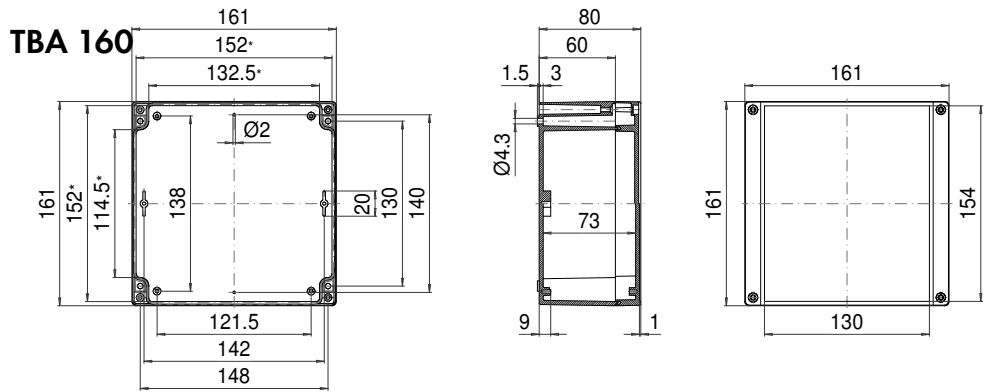

* Please note: Mould slope for casting ejection, dimensions in the amount of the bottom!

Maximum number of cable glands per enclosure side				
C	A	A/B C/D		
	B	PG 7	18	16
M 16	PG 9	10	8	
	PG 11	8	7	
M 20	PG 13,5	6	5	
	PG 16	4	4	
M 25	PG 21	3	3	
M 32	PG 29			
M 40	PG 36			
M 50	PG 42			
M 63	PG 48			

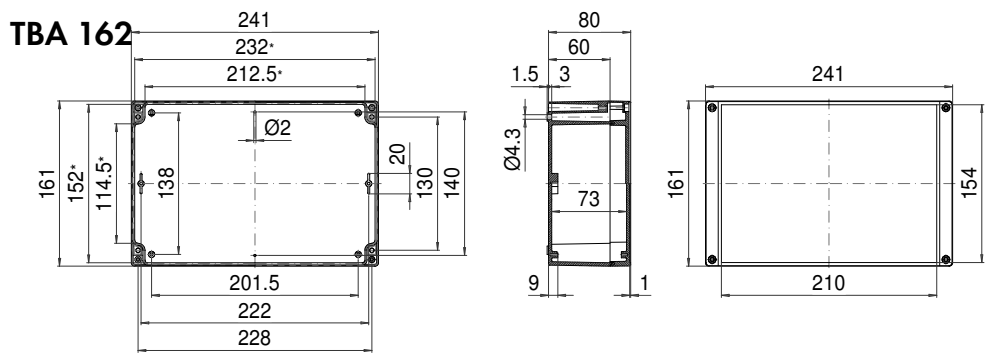

* Please note: Mould slope for casting ejection, dimensions in the amount of the bottom!

Maximum number of cable glands per enclosure side				
C	A	A/B C/D		
	B	PG 7	30	16
M 16	PG 9	24	8	
	PG 11	16	7	
M 20	PG 13,5	16	5	
	PG 16	12	4	
M 25	PG 21	6	3	
M 32	PG 29	4		
M 40	PG 36	2		
M 50	PG 42	2		
M 63	PG 48			