

High Speed Optocoupler, Dual, 5 MBd, in SOIC-8 Package

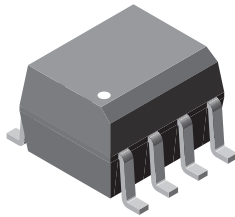

i179074

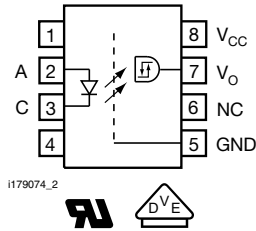

i179074_2



DESCRIPTION

The single channel 5 Mb/s SFH6720T and SFH6721T high speed optocoupler consists of a GaAlAs infrared emitting diode, optically coupled with an integrated photo detector. The detector incorporates a schmitt-trigger stage for improved noise immunity. A faraday shield provides a common mode transient immunity of 1000 V/μs at V_{CM} = 50 V for SFH6720T and 2500 V/μs at V_{CM} = 400 V for SFH6721T.

The SFH6720T and SFH6721T uses an industry standard SOIC-8A package.

AGENCY APPROVALS

- UL1577, file no. E52744 system code Y
- DIN EN 60747-5-5 (VDE 0884) available with option 1

FEATURES

- Data rate 5 Mbits/s (2.5 Mbit/s over temperature)
- Buffer
- Isolation test voltage, 4000 V_{RMS}
- TTL, LSTTL and CMOS compatible
- Internal shield for very high common mode transient immunity
- Wide supply voltage range (4.5 V to 15 V)
- Low input current (1.6 mA to 5 mA)
- Parameters specified from 0 °C to 85 °C
- T_{amb} from - 40 °C to 100 °C
- Compliant to RoHS Directive to 2002/95/EC and in accordance WEEE 2002/96/EC



RoHS
COMPLIANT

APPLICATIONS

- Industrial control
- Replace pulse transformers
- Routine logic interfacing
- Motion/power control
- High speed line receiver
- Microprocessor system interfaces
- Computer peripheral interfaces

ORDERING INFORMATION

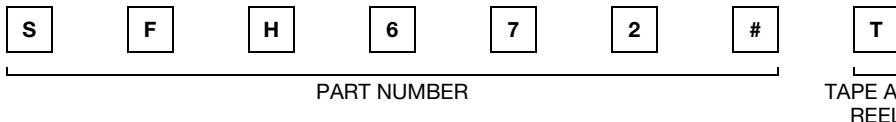

AGENCY CERTIFIED/PACKAGE	CMR (kV/μs)	CMR (kV/μs)
UL	1	2.5
SOIC-8	SFH6720T	SFH6721T
VDE, UL	1	2.5
SOIC-8	SFH6720-X001T	-

TRUTH TABLE (positive logic)

PART	IR DIODE	OUTPUT
SFH6720T	On	H
	Off	L
SFH6721T	On	H
	Off	L

SFH6720T, SFH6721T



Vishay Semiconductors High Speed Optocoupler, Dual,
5 MBd, in SOIC-8 Package

ABSOLUTE MAXIMUM RATINGS ⁽¹⁾ ($T_{amb} = 25\text{ }^{\circ}\text{C}$, unless otherwise specified)				
PARAMETER	TEST CONDITION	SYMBOL	VALUE	UNIT
INPUT				
Reverse voltage		V_R	3	V
DC forward current		I_F	10	mA
Surge forward	$t_p \leq 1\text{ }\mu\text{s}$, 300 pulses/s	I_{FSM}	1	mA
Power dissipation		P_{diss}	20	mW
OUTPUT				
Supply voltage		V_{CC}	- 0.5 to + 15	V
Output voltage		V_O	- 0.5 to + 15	V
Average output current		I_O	25	mA
Power dissipation		P_{diss}	100	mW
COUPLER				
Storage temperature range		T_{stg}	- 55 to + 125	$^{\circ}\text{C}$
Ambient temperature range		T_{amb}	+ 85	$^{\circ}\text{C}$
Isolation test voltage	$t = 1\text{ s}$	V_{ISO}	4000	V_{RMS}
Pollution degree			2	
Creepage distance			4	mm
Clearance distance			4	mm
Comparative tracking index per DIN IEC112/VDE 0303, part 1		CTI	175	
Isolation resistance	$V_{IO} = 500\text{ V}$, $T_{amb} = 25\text{ }^{\circ}\text{C}$	R_{IO}	10^{12}	Ω
	$V_{IO} = 500\text{ V}$, $T_{amb} = 100\text{ }^{\circ}\text{C}$	R_{IO}	10^{11}	Ω
Lead soldering temperature ⁽²⁾	$t = 10\text{ s}$	T_{sld}	260	$^{\circ}\text{C}$

Notes

- (1) Stresses in excess of the absolute maximum ratings can cause permanent damage to the device. Functional operation of the device is not implied at these or any other conditions in excess of those given in the operational sections of this document. Exposure to absolute maximum ratings for extended periods of the time can adversely affect reliability.
- (2) Refer to reflow profile soldering conditions for surface mounted devices.

RECOMMENDED OPERATING CONDITIONS ⁽¹⁾						
PARAMETER	TEST CONDITION	SYMBOL	MIN.	TYP.	MAX.	UNIT
Supply voltage		V_{CC}	4.5		15	V
Forward input current		I_{Fon}	1.6 ⁽²⁾		5	mA
		I_{Foff}			0.1	mA
Operating temperature		T_A	- 40		85	$^{\circ}\text{C}$

Notes

- (1) A 0.1 μF bypass capacitor connected between pins 5 and 8 must be used.
- (2) We recommended using a 2.2 mA if to permit at least 20 % CTR degradation guard band.

ELECTRICAL CHARACTERISTICS ⁽¹⁾						
PARAMETER	TEST CONDITION	SYMBOL	MIN.	TYP.	MAX.	UNIT
INPUT						
Forward voltage	$I_F = 5\text{ mA}$, $25\text{ }^{\circ}\text{C}$	V_F		1.6	1.75	V
		V_F			1.9	V
Input current hysteresis	$V_{CC} = 5\text{ V}$, $I_{HYS} = I_{Fon} - I_{Foff}$	I_{HYS}	0.1			V
Reverse current	$V_R = 3\text{ V}$	I_R		0.5	10	μA
Capacitance	$V_R = 0\text{ V}$, $f = 1\text{ MHz}$	C_O		60		pF
Thermal resistance		R_{thja}		700		K/W

ELECTRICAL CHARACTERISTICS (1)						
PARAMETER	TEST CONDITION	SYMBOL	MIN.	TYP.	MAX.	UNIT
OUTPUT						
Logic low output voltage	$I_{OL} = 6.4 \text{ mA}$	V_{OL}			0.5	V
Logic high output voltage	$I_{OH} = -2.6 \text{ mA}$, $V_{OH} = V_{CC} - 1.8 \text{ V}$	V_{OH}	2.4			V
Output leakage current ($V_{OUT} > V_{CC}$)	$V_O = 5.5 \text{ V}$, $V_{CC} = 4.5 \text{ V}$, $I_F = 5 \text{ mA}$	I_{OHH}		0.5	100	μA
	$V_O = 15 \text{ V}$, $V_{CC} = 4.5 \text{ V}$, $I_F = 5 \text{ mA}$	I_{OHH}		1	500	μA
Logic low supply current	$V_{CC} = 5.5 \text{ V}$, $I_F = 0$	I_{CCL}		3.7	6	mA
	$V_{CC} = 15 \text{ V}$, $I_F = 0$	I_{CCL}		4.1	6.5	mA
Logic high supply current	$V_{CC} = 5.5 \text{ V}$, $I_F = 5 \text{ mA}$	I_{CCH}		3.4	4	mA
	$V_{CC} = 15 \text{ V}$, $I_F = 5 \text{ mA}$	I_{CCH}		3.7	5	mA
Logic low short circuit output current (output short circuit time $\leq 10 \text{ ms}$)	$V_O = V_{CC} = 5.5 \text{ V}$, $I_F = 0$	I_{OSL}	25			mA
	$V_O = V_{CC} = 15 \text{ V}$, $I_F = 0$	I_{OSL}	40			mA
Logic high short circuit output current (output short circuit time $\leq 10 \text{ ms}$)	$V_{CC} = 5.5 \text{ V}$, $V_O = 0 \text{ V}$, $I_F = 5 \text{ mA}$	I_{OSH}			-10	mA
	$V_{CC} = 15 \text{ V}$, $V_O = 0 \text{ V}$, $I_F = 5 \text{ mA}$	I_{OSH}			-25	mA
Thermal resistance		R_{thja}		300		K/W
COUPLER						
Capacitance (input to output)	$f = 1 \text{ MHz}$, pins 1 to 4 and 5 to 8 shorted together	C_{IO}		0.6		pF
Isolation resistance	$V_{IO} = 500 \text{ V}$, $T_{amb} = 25 \text{ }^\circ\text{C}$		10^{12}			Ω
	$V_{IO} = 500 \text{ V}$, $T_{amb} = 100 \text{ }^\circ\text{C}$		10^{11}			Ω

Note

(1) $-40 \text{ }^\circ\text{C} \leq T_{amb} \leq 85 \text{ }^\circ\text{C}$; $4.5 \text{ V} \leq V_{CC} \leq 15 \text{ V}$; $1.6 \text{ mA} \leq I_{Fon} \leq 5 \text{ mA}$; $2 \leq V_{EH} \leq 15 \text{ V}$; $0 \leq V_{EL} \leq 0.8 \text{ V}$; $0 \text{ mA} \leq I_{Foff} \leq 0.1 \text{ mA}$.

Typical values: $T_{amb} = 25 \text{ }^\circ\text{C}$; $V_{CC} = 5 \text{ V}$; $I_{Fon} = 3 \text{ mA}$ unless otherwise specified.

Minimum and maximum values are testing requirements. Typical values are characteristics of the device and are the result of engineering evaluation. Typical values are for information only and are not part of the testing requirements.

SWITCHING CHARACTERISTICS (1)						
PARAMETER	TEST CONDITION	SYMBOL	MIN.	TYP.	MAX.	UNIT
Propagation delay time to logic low output level	Without peaking capacitor	t_{PHL}		120		ns
	With peaking capacitor	t_{PHL}		115	300	ns
Propagation delay time to logic high output level	Without peaking capacitor	t_{PLH}		125		ns
	With peaking capacitor	t_{PLH}		90	300	ns
Output rise time	10 % to 90 %	t_r		40		ns
Output fall time	90 % to 10 %	t_f		10		ns

Note

(1) $0 \text{ }^\circ\text{C} \leq T_{amb} \leq 85 \text{ }^\circ\text{C}$; $4.5 \text{ V} \leq V_{CC} \leq 15 \text{ V}$; $1.6 \text{ mA} \leq I_{Fon} \leq 5 \text{ mA}$; $0 \text{ mA} \leq I_{Foff} \leq 0.1 \text{ mA}$

Typical values: $T_{amb} = 25 \text{ }^\circ\text{C}$; $V_{CC} = 5 \text{ V}$; $I_{Fon} = 3 \text{ mA}$ unless otherwise specified. A $0.1 \mu\text{F}$ bypass capacitor connected between pins 5 and 8 must be used.

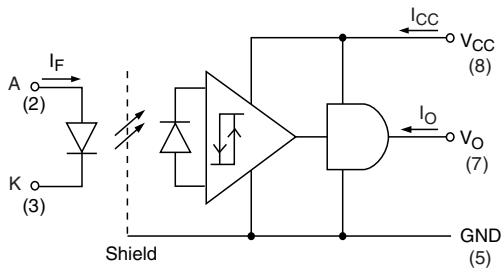

isfh6720_00

COMMON MODE TRANSIENT IMMUNITY (1)							
PARAMETER	TEST CONDITION	PART	SYMBOL	MIN.	TYP.	MAX.	UNIT
Logic high common mode transient immunity (2)	$ V_{CM} = 50\text{ V}, I_F = 1.6\text{ mA}$	SFH6720T	$ CM_H $	1000			V/ μ s
	$ V_{CM} = 300\text{ V}, I_F = 1.6\text{ mA}$	SFH6721T	$ CM_H $	5000			V/ μ s
Logic low common mode transient immunity (2)	$ V_{CM} = 50\text{ V}, I_F = 0\text{ mA}$	SFH6720T	$ CM_L $	1000			V/ μ s
	$ V_{CM} = 1000\text{ V}, I_F = 0\text{ mA}$	SFH6721T	$ CM_L $	10 000			V/ μ s

Note

(1) $T_{amb} = 25\text{ }^\circ\text{C}$, $V_{CC} = 5\text{ V}$. (2)

(2) CM_H is the maximum slew rate of a common mode voltage V_{CM} at which the output voltage remains at logic high level ($V_O > 2\text{ V}$). CM_L is the maximum slew rate of a common mode voltage V_{CM} at which the output voltage remains at logic low level ($V_O < 0.8\text{ V}$).

SAFETY AND INSULATION RATINGS						
PARAMETER	TEST CONDITION	SYMBOL	MIN.	TYP.	MAX.	UNIT
Climatic Classification (according to IEC 68 part 1)				55/100/21		
Comparative Tracking Index		CTI	175		399	
V_{IOTM}			6000			V
V_{IORM}			560			V
P_{SO}					350	mW
I_{SI}					150	mA
T_{SI}					165	$^\circ\text{C}$
Creepage distance			4			mm
Clearance distance			4			mm
Insulation thickness			0.2			mm

Note

• As per IEC 60747-5-5, § 7.4.3.8.1, this optocoupler is suitable for “safe electrical insulation” only within the safety ratings. Compliance with the safety ratings shall be ensured by means of protective circuits.

TYPICAL CHARACTERISTICS ($T_{amb} = 25\text{ }^\circ\text{C}$, unless otherwise specified)

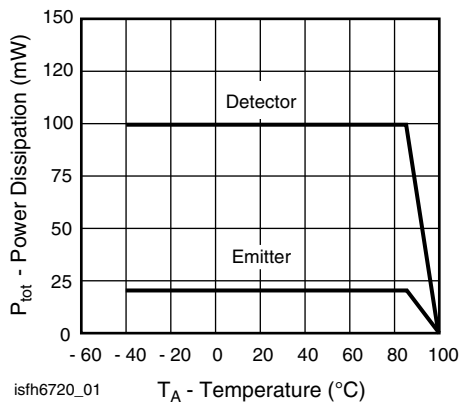

Fig. 1 - Permissible Total Power Dissipation vs. Temperature

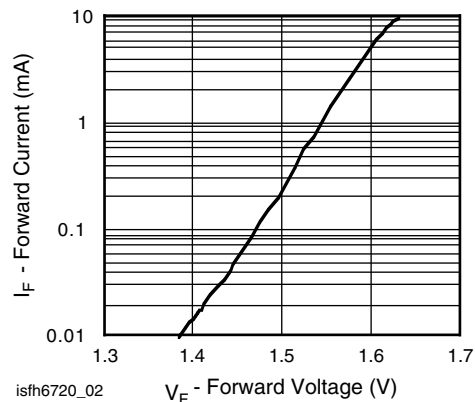

Fig. 2 - Typical Input Diode Forward Current vs. Forward Voltage

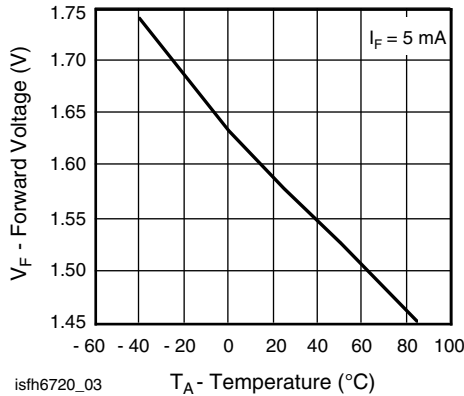

Fig. 3 - Typical Forward Input Voltage vs. Temperature

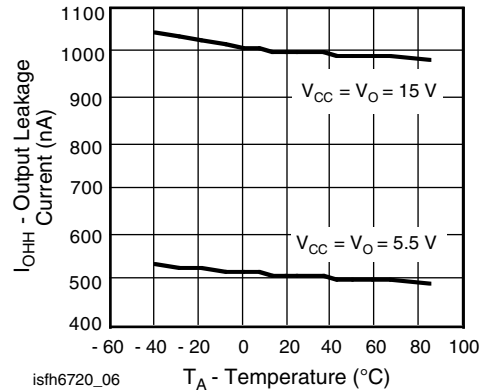

Fig. 6 - Typical Output Leakage Current vs. Temperature

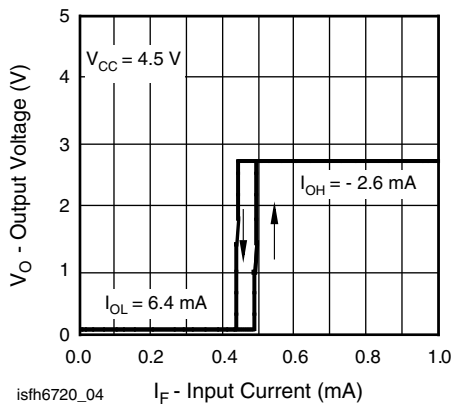

Fig. 4 - Typical Output Voltage vs. Forward Input Current

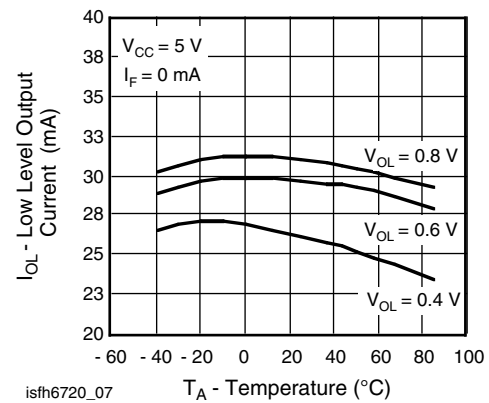

Fig. 7 - Typical Low Level Output Current vs. Temperature

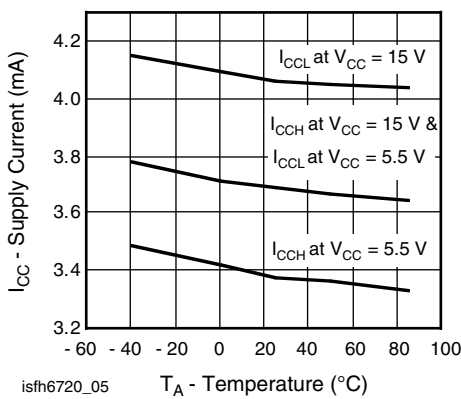

Fig. 5 - Typical Supply Current vs. Temperature

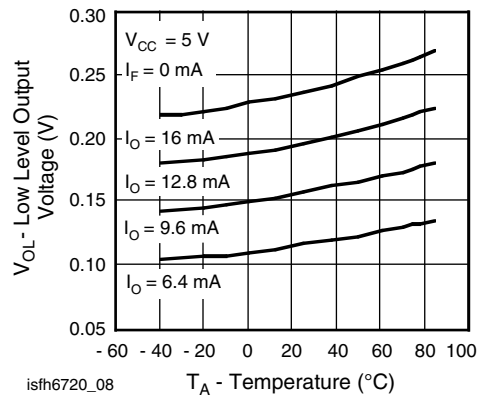

Fig. 8 - Typical Low Level Output Voltage vs. Temperature

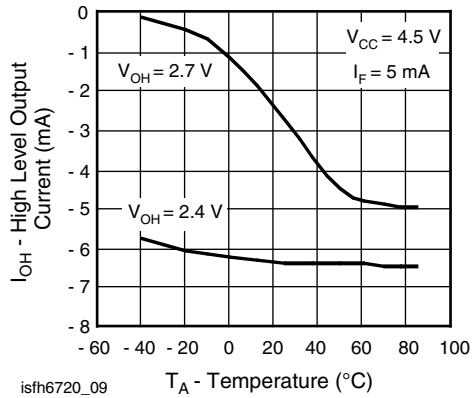

Fig. 9 - Typical High Level Output Current vs. Temperature

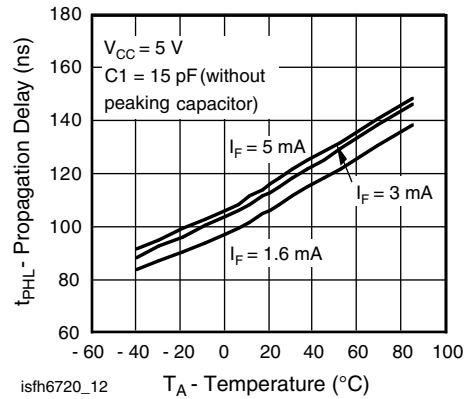

Fig. 12 - Typical Propagation Delays to Logic Low vs. Temperature

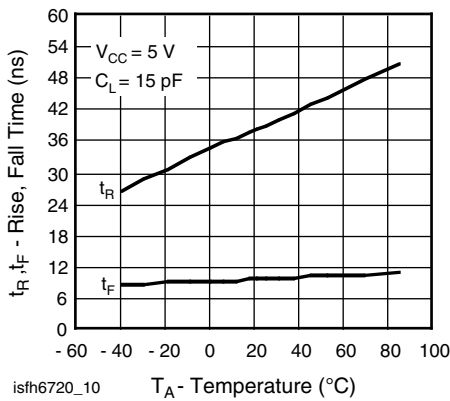

Fig. 10 - Rise and Fall Time vs. Ambient Temperature

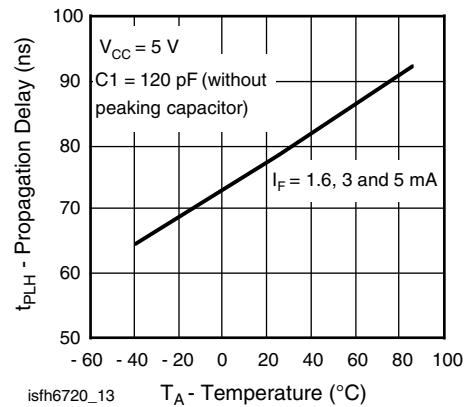

Fig. 13 - Typical Propagation Delays to Logic High vs. Temperature

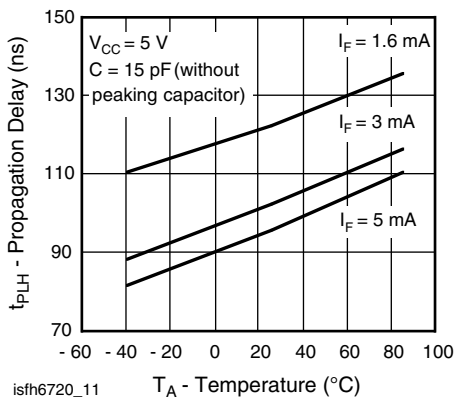

Fig. 11 - Typical Propagation Delays to Logic High vs. Temperature

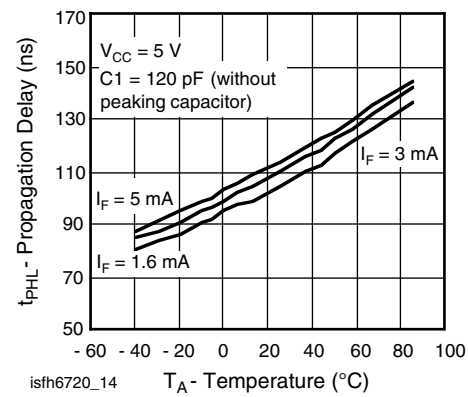

Fig. 14 - Typical Propagation Delays to Logic Low vs. Temperature

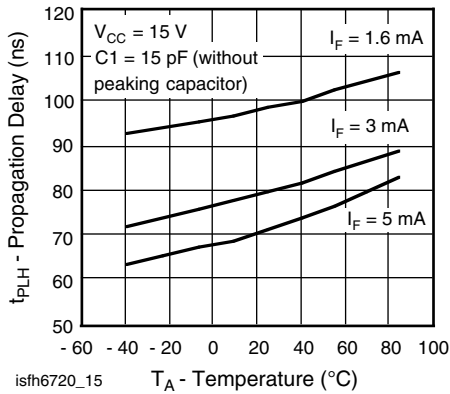

Fig. 15 - Typical Propagation Delays to Logic High vs. Temperature

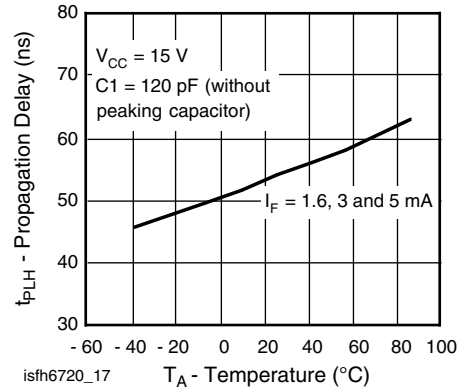

Fig. 17 - Typical Propagation Delays to Logic High vs. Temperature

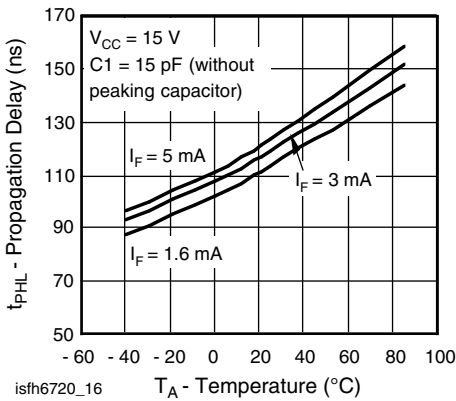

Fig. 16 - Typical Propagation Delays to Logic Low vs. Temperature

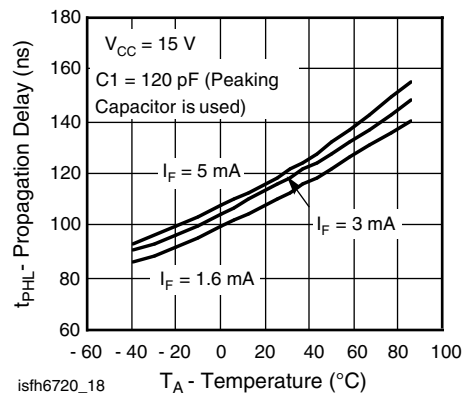

Fig. 18 - Typical Propagation Delays to Logic Low vs. Temperature

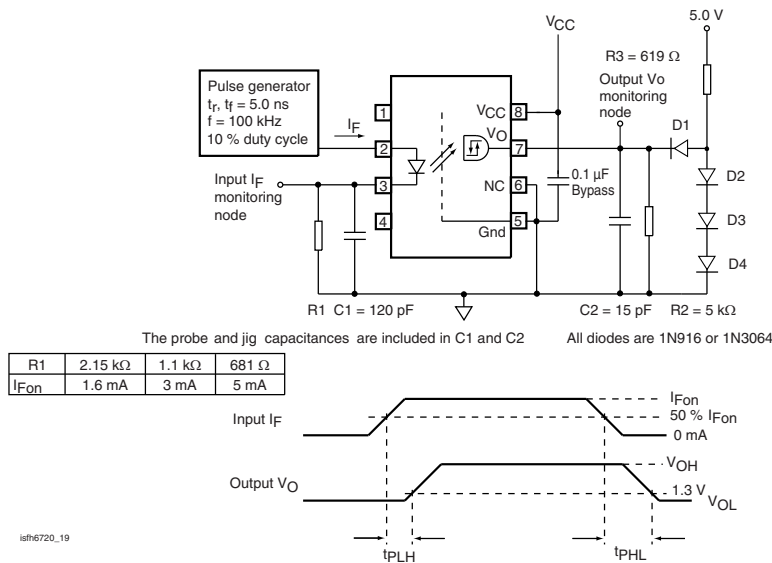

Fig. 19 - Test Circuit for t_{PLH} , t_{PHL} , t_R and t_f

SFH6720T, SFH6721T

Vishay Semiconductors

High Speed Optocoupler, Dual,
5 MBd, in SOIC-8 Package

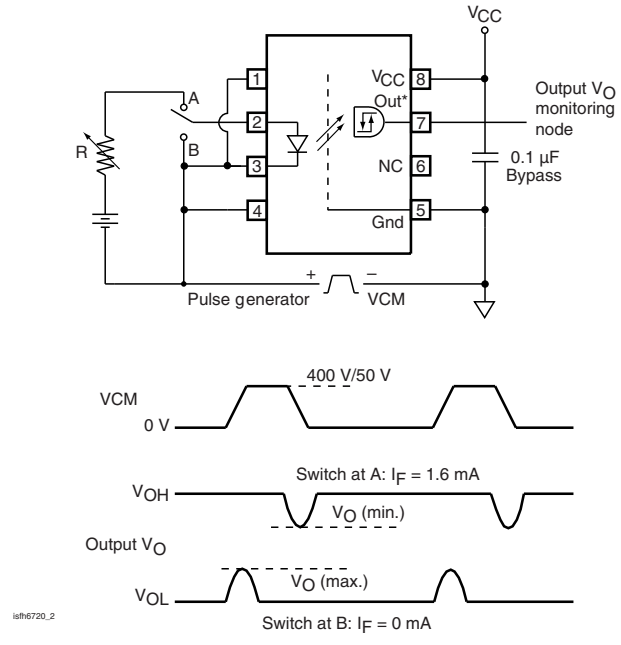
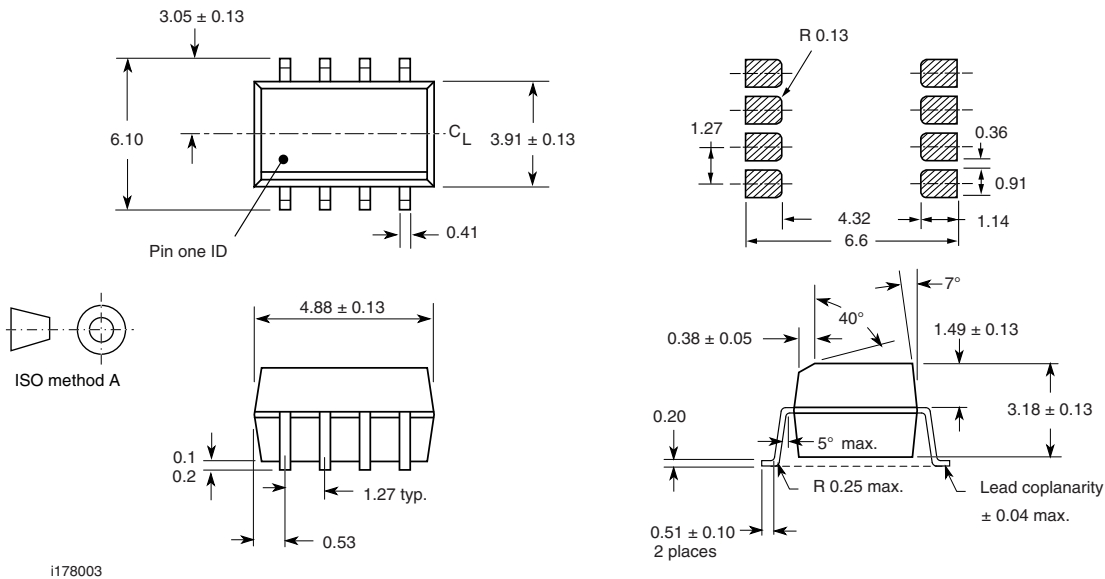

Fig. 20 - Test Circuit for Common Mode Transient Immunity and Typical Waveforms

PACKAGE DIMENSIONS millimeters





Disclaimer

ALL PRODUCT, PRODUCT SPECIFICATIONS AND DATA ARE SUBJECT TO CHANGE WITHOUT NOTICE TO IMPROVE RELIABILITY, FUNCTION OR DESIGN OR OTHERWISE.

Vishay Intertechnology, Inc., its affiliates, agents, and employees, and all persons acting on its or their behalf (collectively, "Vishay"), disclaim any and all liability for any errors, inaccuracies or incompleteness contained in any datasheet or in any other disclosure relating to any product.

Vishay makes no warranty, representation or guarantee regarding the suitability of the products for any particular purpose or the continuing production of any product. To the maximum extent permitted by applicable law, Vishay disclaims (i) any and all liability arising out of the application or use of any product, (ii) any and all liability, including without limitation special, consequential or incidental damages, and (iii) any and all implied warranties, including warranties of fitness for particular purpose, non-infringement and merchantability.

Statements regarding the suitability of products for certain types of applications are based on Vishay's knowledge of typical requirements that are often placed on Vishay products in generic applications. Such statements are not binding statements about the suitability of products for a particular application. It is the customer's responsibility to validate that a particular product with the properties described in the product specification is suitable for use in a particular application. Parameters provided in datasheets and/or specifications may vary in different applications and performance may vary over time. All operating parameters, including typical parameters, must be validated for each customer application by the customer's technical experts. Product specifications do not expand or otherwise modify Vishay's terms and conditions of purchase, including but not limited to the warranty expressed therein.

Except as expressly indicated in writing, Vishay products are not designed for use in medical, life-saving, or life-sustaining applications or for any other application in which the failure of the Vishay product could result in personal injury or death. Customers using or selling Vishay products not expressly indicated for use in such applications do so at their own risk. Please contact authorized Vishay personnel to obtain written terms and conditions regarding products designed for such applications.

No license, express or implied, by estoppel or otherwise, to any intellectual property rights is granted by this document or by any conduct of Vishay. Product names and markings noted herein may be trademarks of their respective owners.

Material Category Policy

Vishay Intertechnology, Inc. hereby certifies that all its products that are identified as RoHS-Compliant fulfill the definitions and restrictions defined under Directive 2011/65/EU of The European Parliament and of the Council of June 8, 2011 on the restriction of the use of certain hazardous substances in electrical and electronic equipment (EEE) - recast, unless otherwise specified as non-compliant.

Please note that some Vishay documentation may still make reference to RoHS Directive 2002/95/EC. We confirm that all the products identified as being compliant to Directive 2002/95/EC conform to Directive 2011/65/EU.

Vishay Intertechnology, Inc. hereby certifies that all its products that are identified as Halogen-Free follow Halogen-Free requirements as per JEDEC JS709A standards. Please note that some Vishay documentation may still make reference to the IEC 61249-2-21 definition. We confirm that all the products identified as being compliant to IEC 61249-2-21 conform to JEDEC JS709A standards.