

Piston rod cylinders → Standard cylinders

Compact cylinder, ISO 21287, Series CCI

► Ø 16 - 100 mm ► Ports: M5 - G 1/8 ► double-acting ► with magnetic piston ► cushioning: elastic ► piston rod: non-rotating, with front plate, internal thread

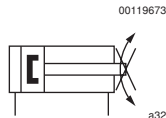
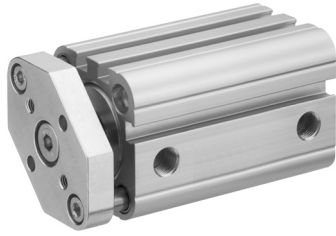

Standards	ISO 21287
Compressed air connection	internal thread
Working pressure min./max.	1 bar / 10 bar
Ambient temperature min./max.	-20 °C / +80 °C
Medium temperature min./max.	-20 °C / +80 °C
Medium	Compressed air
Max. particle size	50 µm
Oil content of compressed air	0 mg/m ³ - 5 mg/m ³
Pressure for determining piston forces	6 bar

Materials:	
Cylinder tube	Aluminum, anodized
Piston rod	Stainless steel
Front cover	Aluminum
End cover	Aluminum
Seal	Polyurethane
Front plate	Aluminum
Nut for piston rod	Steel, galvanized
Scraper	Polyurethane

Technical Remarks

- The pressure dew point must be at least 15 °C under ambient and medium temperature and may not exceed 3 °C.
- The oil content of air pressure must remain constant during the life cycle.
- Use only the approved oils from Bosch Rexroth, see chapter „Technical information“.

Piston Ø	[mm]	16	20	25	32	40
Retracting piston force	[N]	91	137	216	364	560
Extending piston force	[N]	106	164	259	422	665
Impact energy	[J]	0.11	0.15	0.2	0.4	0.52
Weight	0 mm stroke	0.071	0.119	0.155	0.303	0.383
	+10 mm stroke	0.019	0.026	0.03	0.05	0.06
Stroke max.	[mm]	300	300	300	300	300

Piston Ø	[mm]	50	63	80	100
Retracting piston force	[N]	871	1478	2397	3886
Extending piston force	[N]	1035	1647	2656	4145
Impact energy	[J]	0.64	0.75	0.75	1
Weight	0 mm stroke	0.626	0.907	1.462	2.641
	+10 mm stroke	0.09	0.107	0.136	0.188
Stroke max.	[mm]	300	300	500	500

Piston rod cylinders → Standard cylinders

Compact cylinder, ISO 21287, Series CCI

► Ø 16 - 100 mm ► Ports: M5 - G 1/8 ► double-acting ► with magnetic piston ► cushioning: elastic ► piston rod: non-rotating, with front plate, internal thread

	Piston Ø Piston rod thread Ports Piston rod Ø	16	20	25	32	40	
		M4 M5 8	M6 M5 10	M6 M5 10	M8 G 1/8 12	M8 G 1/8 12	
	Stroke 5	R422001262	R422001263	R422001264	R422001265	R422001266	
	10	R422001272	R422001273	R422001274	R422001275	R422001276	
	15	R422001282	R422001283	R422001284	R422001285	R422001286	
	20	R422001292	R422001293	R422001294	R422001295	R422001296	
	25	R422001302	R422001303	R422001304	R422001305	R422001306	
	30	R422001312	R422001313	R422001314	R422001315	R422001316	
	40	R422001322	R422001323	R422001324	R422001325	R422001326	
	50	R422001332	R422001333	R422001334	R422001335	R422001336	
	60	R422001342	R422001343	R422001344	R422001345	R422001346	
	80	-	-	-	R422001355	R422001356	
	100	-	-	-	R422001365	R422001366	
	125	-	-	-	R422001375	R422001376	
	150	-	-	-	R422001385	R422001386	
		Piston Ø Piston rod thread Ports Piston rod Ø	50 M10 G 1/8 16	63 M10 G 1/8 16	80 M12 G 1/8 20	100 M12 G 1/8 25	
		Stroke 5	R422001267	R422001268	R422001269	R422001270	
		10	R422001277	R422001278	R422001279	R422001280	
		15	R422001287	R422001288	R422001289	R422001290	
		20	R422001297	R422001298	R422001299	R422001300	
		25	R422001307	R422001308	R422001309	R422001310	
		30	R422001317	R422001318	R422001319	R422001320	
	40	R422001327	R422001328	R422001329	R422001330		
	50	R422001337	R422001338	R422001339	R422001340		
	60	R422001347	R422001348	R422001349	R422001350		
	80	R422001357	R422001358	R422001359	R422001360		
	100	R422001367	R422001368	R422001369	R422001370		
	125	R422001377	R422001378	R422001379	R422001380		
	150	R422001387	R422001388	R422001389	R422001390		

Piston rod cylinders → Standard cylinders

Compact cylinder, ISO 21287, Series CCI

► Ø 16 - 100 mm ► Ports: M5 - G 1/8 ► double-acting ► with magnetic piston ► cushioning: elastic ► piston rod: non-rotating, with front plate, internal thread

Maximum permissible lateral force, Static

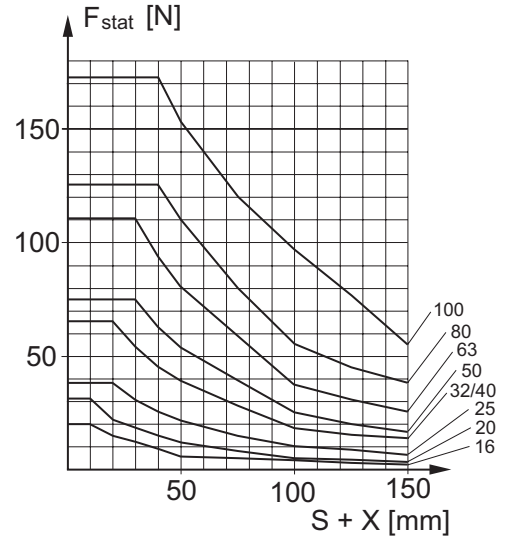
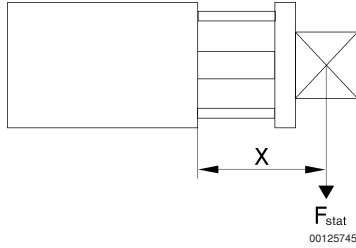

F_{stat} = static lateral force

X = spacing between force application point and cylinder cover

S = stroke

Maximum permissible lateral force, Dynamic

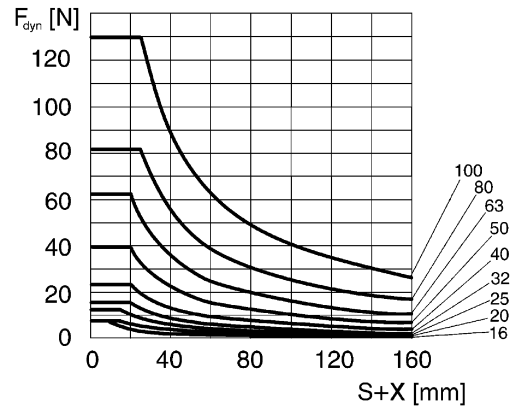
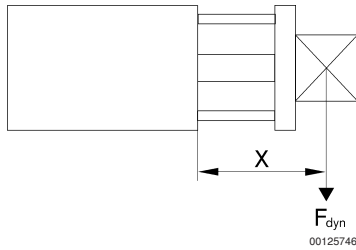

F_{dyn} = dynamic lateral force

X = spacing between force application point and cylinder cover

S = stroke

Piston rod cylinders → Standard cylinders
Compact cylinder, ISO 21287, Series CCI

► Ø 16 - 100 mm ► Ports: M5 - G 1/8 ► double-acting ► with magnetic piston ► cushioning: elastic ► piston rod: non-rotating, with front plate, internal thread

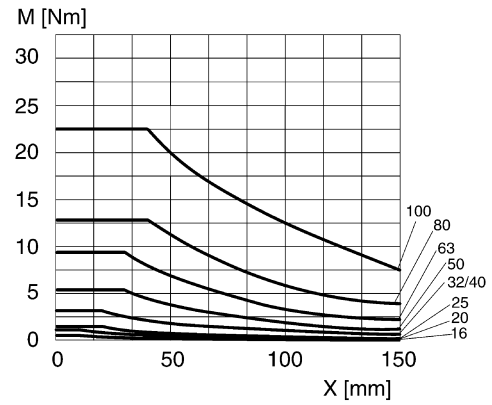
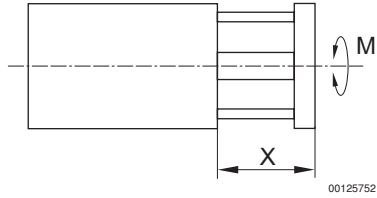
Max. permissible torque

M = max. permissible torque

X = spacing between torque contact surface and cylinder cover

Piston rod cylinders → Standard cylinders

Compact cylinder, ISO 21287, Series CCI

► Ø 16 - 100 mm ► Ports: M5 - G 1/8 ► double-acting ► with magnetic piston ► cushioning: elastic ► piston rod: non-rotating, with front plate, internal thread

Ø 16 - 100 mm

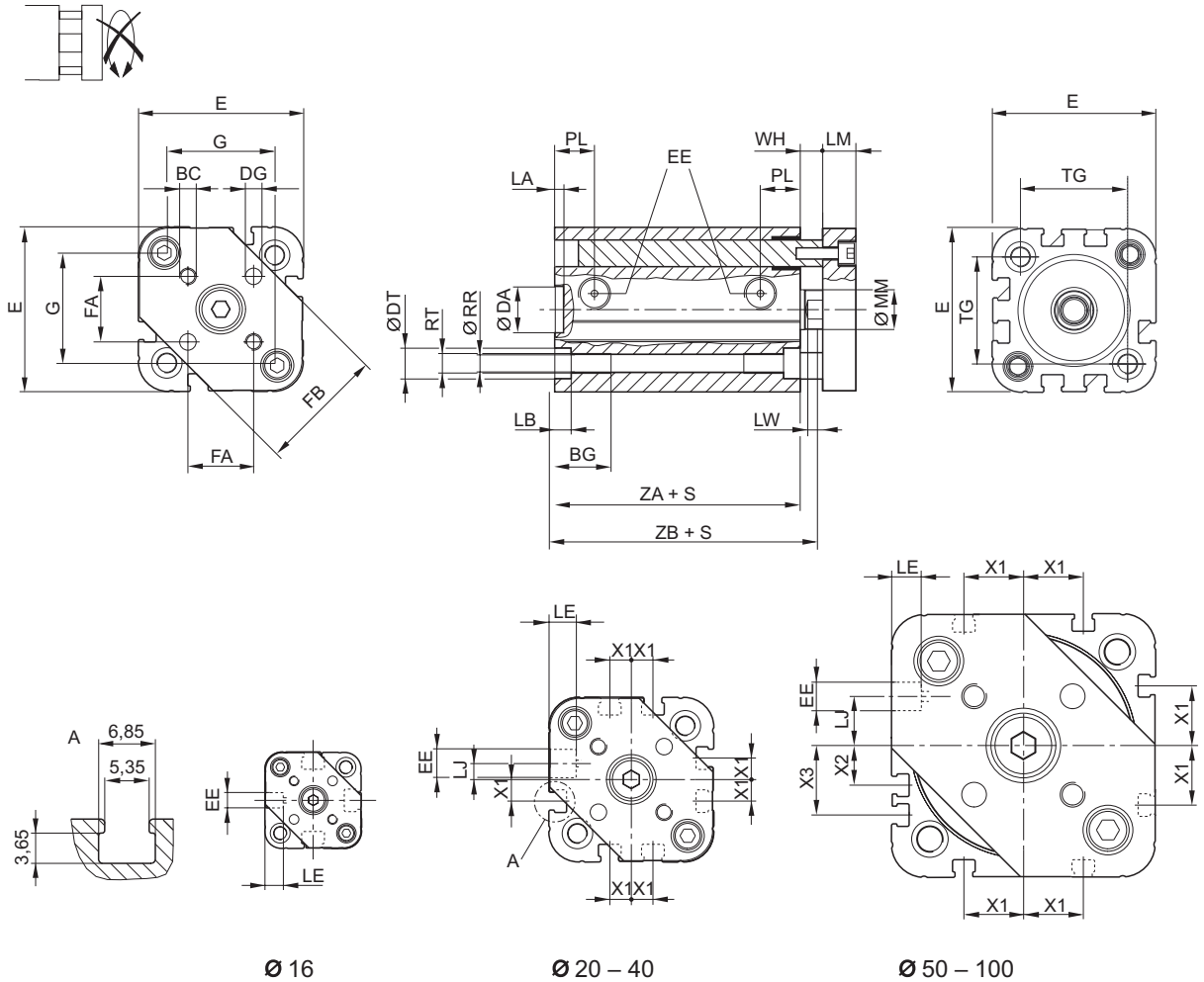

S = stroke
G = distance between the guide rods
TG = distance between the mounting threads

00119662

Piston Ø	BC	BG	DA H11	DG H13	DT	E	EE	FA	FB	G	LA	LB
16	M3	15	10	3	6	29.3	M5	9,9 ±0,1	20	19	2.5	3.5
20	M4	15.5	12	4	7.5	36.3	M5	12 ±0,1	24	25	2.5	4.5
25	M5	15.5	12	5	8	40.3	M5	15,6 ±0,1	30	27	2.5	4.5
32	M5	17	14	5	9.2	50	G 1/8	19,8 ±0,1	38	34	2.5	5
40	M5	17	14	5	9.2	58	G 1/8	23,3 ±0,1	44	42	2.5	5
50	M6	17	18	6	11	68.3	G 1/8	29,7 ±0,1	54	49	2.5	5
63	M6	17	18	6	11	80	G 1/8	35,4 ±0,1	62	60	2.5	5
80	M8	20	23	8	15	96	G 1/8	46 ±0,1	80	72	3	5
100	M10	20	28	10	15	116	G 1/8	56,6 ±0,1	100	92	3	5

Piston Ø	LE	LJ	LM	LW	MM f8	PL	RR	RT 6H	TG	WH	X1	X2	X3
16	4.5	-	6	4	8	8	3.3	M4	18	4,8 ±0,9	-	-	-
20	4.5	4.5	8	4	10	11	4.2	M5	22	6,3 ±0,9	4.2	-	-
25	4.5	4	8	4	10	11	4.2	M5	26	5,6 ±0,9	4.5	-	-

Part numbers marked in bold are available from the central warehouse in Germany, see the shopping basket for detailed information Pneumatics catalog, online PDF, as of 2010-03-12, © Bosch Rexroth AG, subject to change

Piston rod cylinders → Standard cylinders

Compact cylinder, ISO 21287, Series CCI

► Ø 16 - 100 mm ► Ports: M5 - G 1/8 ► double-acting ► with magnetic piston ► cushioning: elastic ► piston rod: non-rotating, with front plate, internal thread

Piston Ø	LE	LJ	LM	LW	MM f8	PL	RR	RT 6H	TG	WH	X1	X2	X3
32	7.5	4.85	10	4.5	12	12	5.1	M6	32.5	7,4 ±0,9	6.5	-	-
40	7.5	9.85	10	4.5	12	12	5.1	M6	38	7,4 ±0,9	11	-	-
50	7.5	12	12	6	16	12	6.7	M8	46.5	8,4 ±0,9	13	4	13
63	7.5	14.8	12	6	16	12	6.7	M8	56.5	8,5 ±0,9	18	12	21
80	7.5	22	14	7	20	14	8.5	M10	72	9,8 ±1	18	16.5	25.5
100	7.5	27	14	7	25	16.5	8.5	M10	89	9,8 ±1	20	20	29

Piston Ø	ZA	ZB											
16	34,9 ±0,1	39,7 ±0,8											
20	37,3 ±0,1	43,6 ±0,8											
25	39 ±0,1	44,5 ±0,9											
32	44 ±0,1	51,4 ±1											
40	45 ±0,1	52,4 ±1											
50	45,5 ±0,1	53,6 ±1											
63	49 ±0,1	57,4 ±1											
80	54,7 ±0,1	64,4 ±1											
100	67 ±0,1	76,7 ±1											