

Ultrasonic Sensor M18 - Straight or 90° angled version

Plastic : XX●18P1●M12
 Ni-plated Brass : XX●18B1●M12
 Stainless steel : XX●18S1●M12

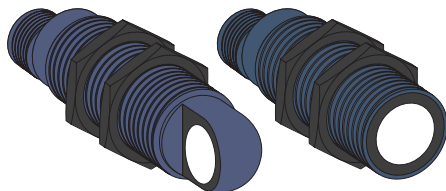

http://qr.tesensors.com/XX0003

LEDs



GN: Green (Echo status)
 YE: Yellow (Output status)

Dimensions

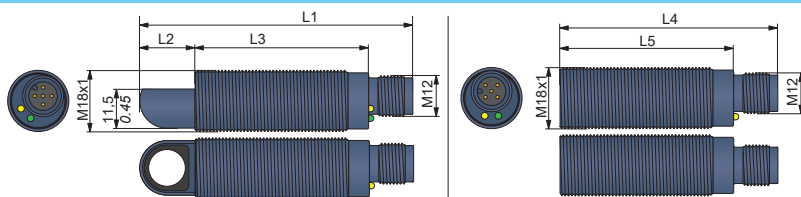

	L1	L2	L3	L4	L5
XX●18B1●M12	80.25	16.25	51	64	51
XX●18S1●M12	(3.16)	(0.64)	(2.01)	(2.52)	(2.01)
XX●18P1●M12	80	16.9	50.6	64	52
	(3.15)	(0.67)	(1.99)	(2.52)	(2.05)

Tightening torque

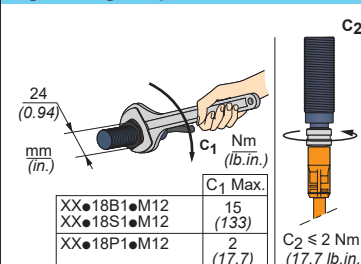

	C1 Max.
XX●18B1●M12	15
XX●18S1●M12	(133)
XX●18P1●M12	2
	(17.7)

C2 ≤ 2 Nm / (17.7 lb.in.)

Connectors wiring

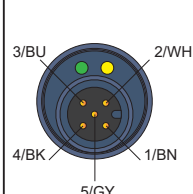

Pin Number	Wire Color	Description
①	BN: Brown	+12...24 Vdc
②	WH: White	Input teach
③	BU: Blue	0 Vdc
④	BK: Black	Output (PNP)
⑤	GY: Grey	Synchronization

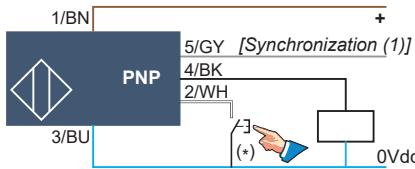

(*) External setting push button or XXZPB100
 Note: (1): See synchronization section

Wiring accessory

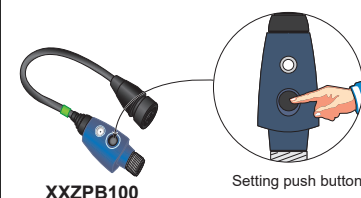

Wiring diagrams

Analog Output

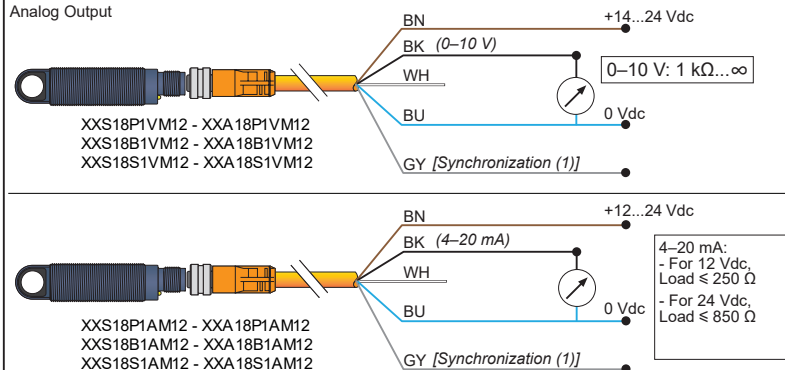

Note: (1): See synchronization section.

Operating diagram

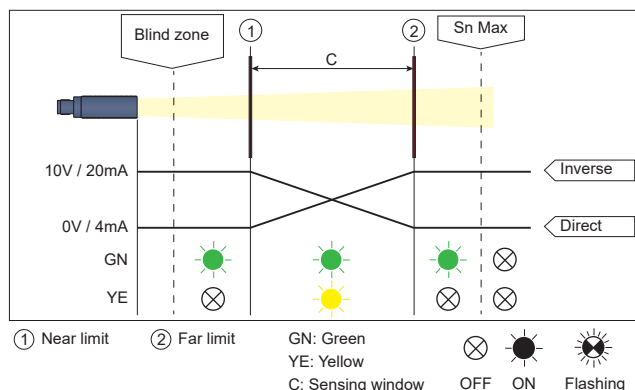

Sensor setting for analog measurement

A Near and far limits setting (2)

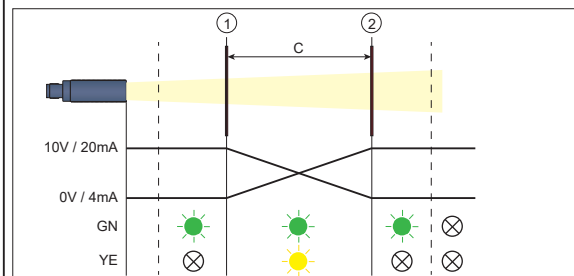

1 Push and hold the teach button and release it (between 3...6 seconds) when the green LED is steady. On releasing, the green LED will start flashing.

2 Position object at the near limit. Push and release the teach button quickly. Now the yellow LED will be steady and the green LED will continue flashing.

3 Position object at the far limit. Push and release the teach button quickly to return to normal operation (3).

Note: (2): The teaching order of the near and far limits can be interchanged.
 (3): The sensor returns to the normal operating mode if the Teach is good.

WARNING

UNINTENDED EQUIPMENT OPERATION

Do not use this product to detect objects within the deadband (blind zone) or outside the sensing window.
 Failure to follow these instructions can result in death, serious injury, or equipment damage.

Electrical equipment should be installed, operated, serviced, and maintained only by qualified personnel.
 No responsibility is assumed by Schneider Electric for any consequences arising out of the use of this material.

© 2018 Schneider Electric. "All Rights Reserved."

Sensor setting with teach procedure

B Output mode Setting: Direct or inverse slope

1

Push and hold the teach button. (Between 6...9 seconds) Release when the yellow LED is steady. Both LEDs flash for approx. 2 seconds and the analog output slope switches from Inverse to Direct or from Direct to Inverse.

D Sensor reset (4)

1

Push and hold the teach button. (Between 9...15 seconds) Release when both the LEDs are flashing. The sensor is now reset to its default setting (5).

Note:

(4): If this XX sensor is intended to be used as a replacement for an XXS● or XXA● sensor in your equipment, please read the following message - The original XX sensor may be configured using the XX configuration software. In this case, the software setting will become the default setting. Please confirm with the OEM, sensors vendor or Telemecanique sales representative while replacing the original XXS● or XXA● sensor of your equipment.

(5): Near limit, far limit, output slope are reset. By default the sensor is in full sensing range & direct slope.

Tilt angle

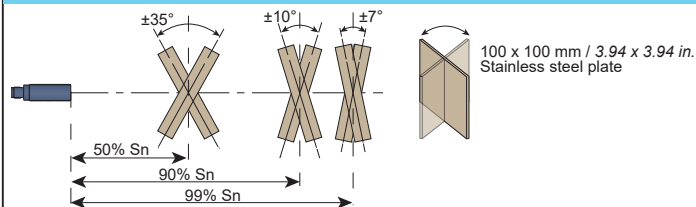

Detection curves for different objects

Detection curve with 100 x 100 mm square target

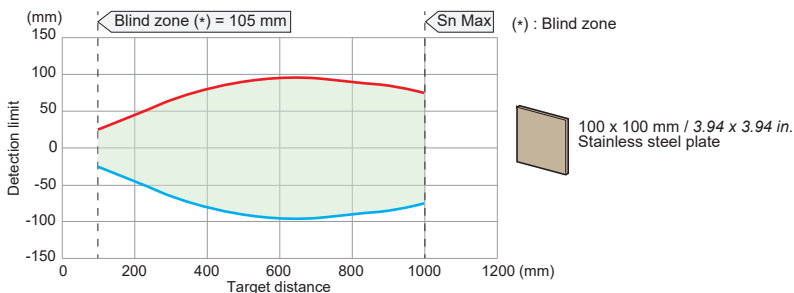

Detection curve with round bar

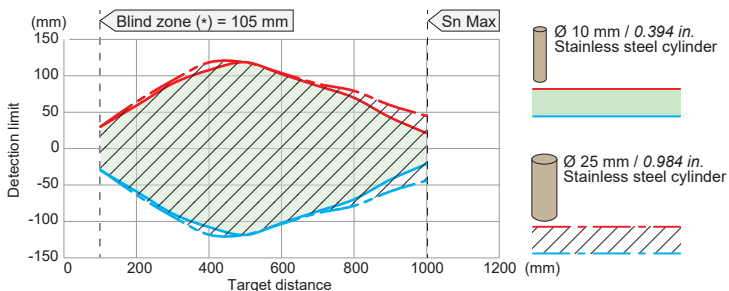

Synchronization (side by side application)

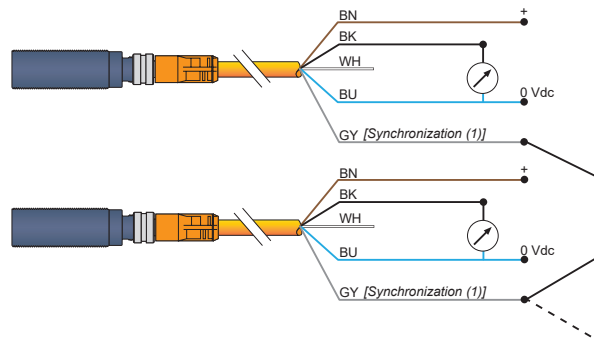

Synchronization operation

To enable synchronization between several sensors, all of the wires of pin no.5 (grey) must be electrically connected together. A maximum of 8 sensors can be synchronized.

Connection with a PLC for synchronization

The sensors are synchronized when the pins no.5 are simultaneously driven by the rising edge of a pulse. More than 8 sensors can be synchronized by using PLC output.

NOTE (1): The pulse must be at a high level of 10 to 24 Vdc and a low level of 0 to 2Vdc. The period of the pulses must be at least 15 ms (cycle time of the sensor).

NOTE (2): When the pin no.5 is at low level or at high level, object sensing is suspended and the sensor output holds the last valid output state before suspension.

Cabling Accessories

Cables

5-pin, 5-wire (for synchronization)

XZCPV11V12L2 (2 m / 6.6 ft)
XZCPV11V12L5 (5 m / 16.4 ft)
XZCPV11V12L10 (10 m / 32.8 ft)

XZCPV12V12L2 (2 m / 6.6 ft)
XZCPV12V12L5 (5 m / 16.4 ft)
XZCPV12V12L10 (10 m / 32.8 ft)

5-pin, 4-wire (no synchronization)

XZCP1141L2 (2 m / 6.6 ft)
XZCP1141L5 (5 m / 16.4 ft)
XZCP1141L10 (10 m / 32.8 ft)

XZCP1241L2 (2 m / 6.6 ft)
XZCP1241L5 (5 m / 16.4 ft)
XZCP1241L10 (10 m / 32.8 ft)

M12 connectors

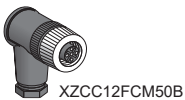
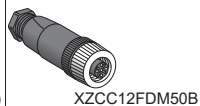

Mounting accessory

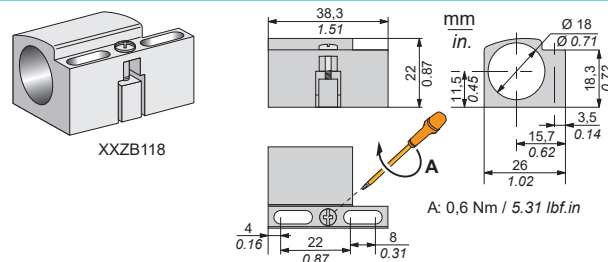

Recommended to use for sensor applications at operating temperatures -25 ... 0 °C (-13...32 °F)