



Inspired Wireless M2M Technology



## QUARTZ Series

3G & 4G Dual LAN Industrial Router Range

Hardware Reference Manual  
Rev 1.5

# Table of Contents

	Page		
<b>Introduction</b>	<b>3</b>	<b>Installation</b>	<b>21</b>
<b>About Siretta</b>	<b>4</b>	Considerations for Installations Incorporating the Router	21
<b>General Description</b>	<b>5</b>	Power Supply Installation	22
Features	6	Securing the Router	22
Specifications	6	<b>Safety and Product Care</b>	<b>23</b>
QUARTZ Series Interface	7	General Precautions	23
Ordering Information	8	SIM Card Precautions	23
<b>Dimensions</b>	<b>9</b>	Antenna Precautions	24
<b>QUARTZ Series Images</b>	<b>10</b>	Exposure to RF Energy	24
<b>QUARTZ Series LED Indicators</b>	<b>11</b>	<b>Safety Recommendations</b>	<b>26</b>
<b>Interfaces</b>	<b>12</b>	<b>Approvals</b>	<b>27</b>
RS232 linkCONNECT port (RJ45)	12	<b>Disclaimer</b>	<b>28</b>
LAN / WAN Port	13	<b>Definitions</b>	<b>29</b>
Input / Output	14		
<b>SIM Socket</b>	<b>15</b>		
SIM Requirements	15		
<b>Antenna Connectors</b>	<b>16</b>		
Main Antenna Connector	17		
GPS Antenna Connector	17		
WiFi Antenna Connector	17		
<b>GPS</b>	<b>18</b>		
GPS Performance (QUARTZ-G Variants)	18		
<b>WiFi</b>	<b>18</b>		
WiFi Performance (QUARTZ-W Variants)	18		
<b>Power</b>	<b>19</b>		
Power Supply Requirements	19		
Power Consumption	19		
Switching the Router ON/OFF	20		

## Introduction

This document is intended to provide guidance when adding a router from the routeCONNECT QUARTZ Series to your system.

The QUARTZ Series is a range of UMTS / LTE routers enabling mobile broadband and machine to machine (M2M) industrial communication.

This document is aimed at engineers and describes the electrical characteristics, hardware and software operation of the QUARTZ modem.

## About Siretta

Siretta, located in Reading, United Kingdom have been manufacturing antennas, cable assemblies and cellular modems for over 10 years. We supply our products globally to many of the world's leading organisations.

Whether you require an off the shelf or custom solution, Siretta has a wide portfolio of antenna, RF cable assemblies and modems to fit your application.

Our extensive knowledge and experience in the wireless market allows us to support a wide range of customer applications, focusing on frequencies typically within the 75MHz - 5.8GHz range. These encompass the HF, VHF, ISM, GSM/GPRS/3G/4G and GPS frequencies as well as industrial WLAN and VHF/UHF antenna/Wi-Fi antenna solutions.

With a heavy emphasis on design, we have a team of dedicated Application Engineers and Product Managers, backed up by Field Sales Engineers, who specialise in wireless applications.

We have made significant investments in R&D facilities which boast GPS hardware development equipment and a GSM Pico Cell on site, as well as development software and a comprehensive suite of Industrial, Scientific and Medical band, and non ISM band frequency products. We have many technology partners enabling us to keep at the forefront of the communications industry and offer class leading wireless solutions.

## General Description

The Siretta QUARTZ router series is an internet of things enabled mobile broadband and machine to machine (M2M) industrial cellular router. The router works with the 3G UMTS and 4G LTE cellular networks to provide reliable, secure and high speed wireless connectivity.

The QUARTZ router series is a powerful and programmable range designed for use in industrial environments with high performance and a robust hard enclosure as standard. The QUARTZ router series have been designed for remote management, telemetry, condition monitoring, CCTV, ATMs, vending machine and other M2M applications.

The QUARTZ router series is an ideal wireless data transfer device for high speed data applications transferring large amounts of data. The series include fast transfer speeds using the UMTS / 3G and 4G LTE networks, reaching up to 21Mbps download and up to 5.76Mbps upload for 3G and 50M upload and 100M download for 4G. In addition the QUARTZ router series is supplied with integrated digital I/O and support for industrial VPN. The industrial grade VPN features can be configured in the router which allows you to utilize virtual private network service through the 3G / 4G connection and directly access the industrial server environment.

Incorporating dual SIM functionality as standard, the QUARTZ router series allows you to setup a backup cellular network between two different SIM cards to ensure a permanent reliable connection regardless of individual network availability.

The QUARTZ router series has an optional GPS engine which provides position and location based service capability, this makes the QUARTZ router series ideal for fleet tracking and device access management. With dual port Ethernet capability, RJ45 serial RS232 offering linkCONNECT solution and 3 digital I/O the QUARTZ router family offers a comprehensive array of features to empower your application.

## Features

- » Global 3G / UMTS bands
- » European 4G / LTE bands
- » RS232 linkCONNECT Port (RJ45)
- » 3 x Digital I/O
- » High speed data via UMTS & LTE network
- » Strong resistance to electromagnetic interference
- » Built-in watch dog, multi-link detection
- » Industrial, robust design with metal housing
- » Dual SIM for failover / backup between network
- » WAN supports PPOE, Static IP, DHCP Client
- » Supports DHCP server
- » Supports DNS proxy and Dynamic DNS (DNSS)
- » Supports timing operation
- » Supports LED status indication
- » Supports APN and VDPN wireless private network access
- » Supports 802.11b/g/n WiFi, 150Mbps data rate
- » Local and remote management
- » SNMP network management, NTP support

## Specifications

Table 1. Specifications of QUARTZ Series routers

	QUARTZ UMTS	QUARTZ LTE
3G frequency band:	800/850, 900, 1900, 2100MHz	800/850, 900, 1900, 2100MHz
4G frequency band:		800, 900, 1800, 1900, 2100, 2600MHz
Dimensions:	102mm x 100mm x 42mm	102mm x 100mm x 42mm
Weight:	300g	300g
Supply voltage:	7.5 - 26VDC	7.5 - 26VDC
Operating temperature range:	-30 to 70°C	-30 to 70°C
Antenna interface:	SMA Female	2 x SMA Female

## QUARTZ Series Interface

### Standard Router Features

#### Hardware

The QUARTZ Series routers come with the following interfaces:

- » 2 x 10/100Mb LAN (2 x LAN)
- » 1 x RS232 linkCONNECT port (RJ45) - available on RJ45 console port
- » 3 x I/O (Input/Output - user defined) - available on 8-way molex connector
- » 1 x 3G/4G SMA female antenna interface
- » 2 x standard SIM/R-UIM interface
- » 1 x standard DC power interface - available on 8-way molex connector

### Optional Router Features

#### Optional Hardware

The QUARTZ Series routers have the following optional hardware features:

- » 1 x 10/100Mb Ethernet LAN, 1 x 10/100Mb Ethernet WAN
- » 1 x GPS SMA female antenna interface
- » 1 x WiFi SMA female antenna interface

#### Optional Technologies

The QUARTZ Series have the following optional technologies available:

- » UMTS (Global 3G)
- » LTE (European 4G)

## Ordering Information

	QUARTZ	XX	X	X	XXXX
<b>Range Identifier</b> QUARTZ = Industrial Router Range					
<b>Optional Antenna Interfaces*</b> G = GPS W = WiFi					
<b>Number of Ethernet Ports</b> 1 = 1 x Ethernet LAN Port, 1 x Ethernet WAN Port 2 = 2 x Ethernet LAN Ports					
<b>Number of SIM Ports</b> 1 = 1 x SIM Port 2 = 2 x SIM Ports					
<b>Technology</b> UMTS = Global 3G LTE = European 4G					

## Part Numbering Examples

- » QUARTZ-12-UMTS = Global UMTS Industrial Router with 1 x Ethernet LAN, 1 x Ethernet WAN and, 2 x SIM Port Interfaces
- » QUARTZ-GW22-LTE = European LTE Industrial Router with 2 x Ethernet LAN and 2 x SIM Port Interfaces, with GPS and WiFi

\*If you do not require an additional antenna interface, leave this blank.



## Dimensions

All dimensions are shown in mm.

Figure 1. QUARTZ Series - front

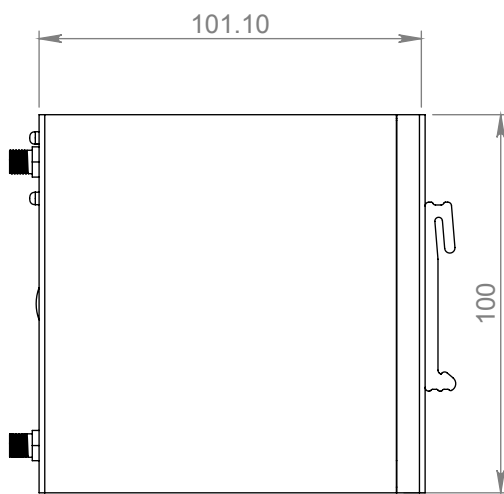

Figure 2. QUARTZ Series - side

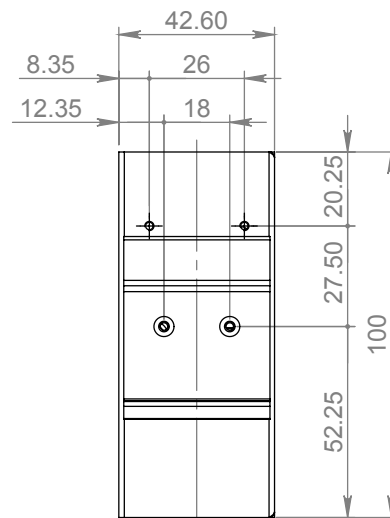

Figure 3. QUARTZ Series - Antenna connectors, LAN interfaces and LEDs

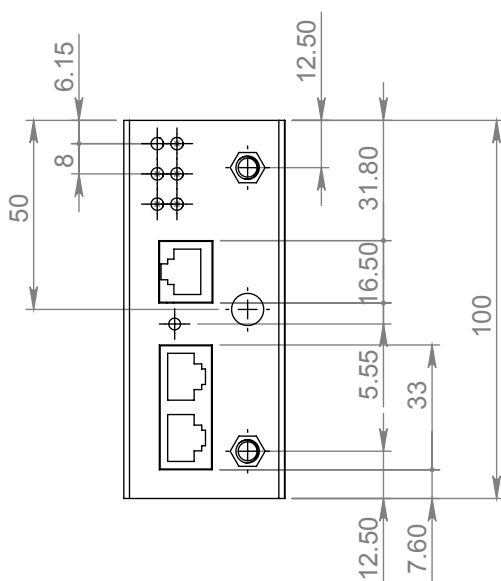

Figure 4. QUARTZ Series - molex connector

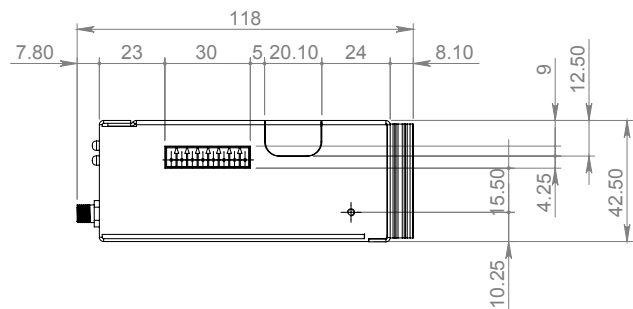
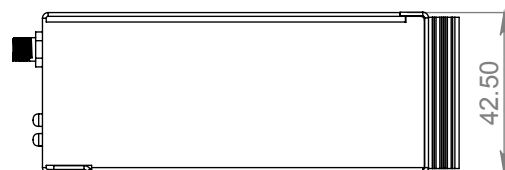

Figure 5. QUARTZ Series - side



## QUARTZ Series Images

Figure 6. 3D view of the QUARTZ Router



Figure 7. Front view of the QUARTZ Router



Figure 8. Antenna, Power, Console, LED, LAN / WAN Interfaces



Figure 9. SIM & I/O



## QUARTZ LED Indicators

The state of the QUARTZ Router is indicated by the status LEDs as shown in table 3 below.

Figure 10. QUARTZ LED's

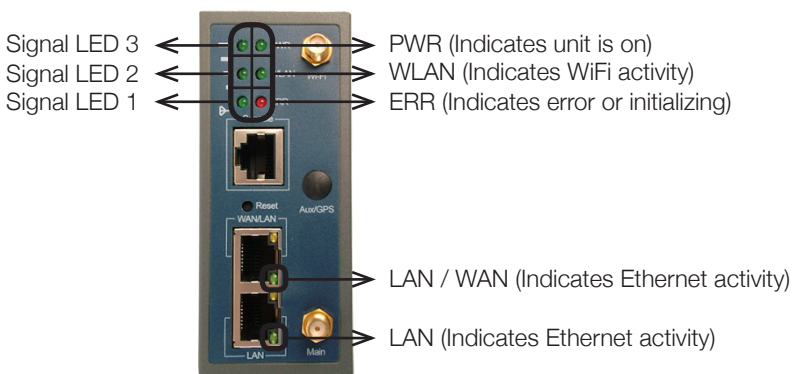

Table 2. Device status LED

Silk screen	Status	Indication	
Signal	Signal	Solid light	
	Signal 1	Blink	LED1 indicates signal is weak (CSQ0~10). LED2 indicates signal is good (CSQ11~19). LED3 indicates signal is strong (CSQ20~31)
		Solid light	Dialling Online
PWR	Solid light	System power operation	
WLAN	Solid light	WLAN enabled, but no data communication	
	Blinking quickly	Data transmitting	
	Continuously off	WLAN disabled	
ERR	Continuously off	System operation and 3G / 4G online	
	Solid light (Red)	System fail indicator (indicates SIM / module fail)	
LAN	Green	Solid light	Connected
	Green	Blinking	Data transmitting

## Interfaces

### RS232 linkCONNECT Port (RJ45)

The RS232 linkCONNECT port (RJ45) enables connection from the router to your laptop or other devices. To enable this connection you will need a RJ45-DB9 cable seen below in **figure 14** (please speak to your Siretta representative), once connected you can connect your RS232 serial devices to a central server and provide polling and diagnostics of remote equipment.

Figure 11. RS232 serial port

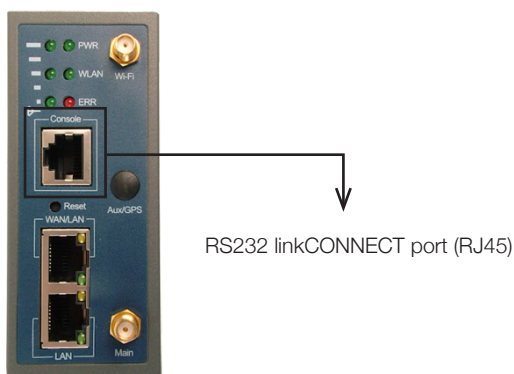

Figure 12. RS232 RJ45 pin numbering

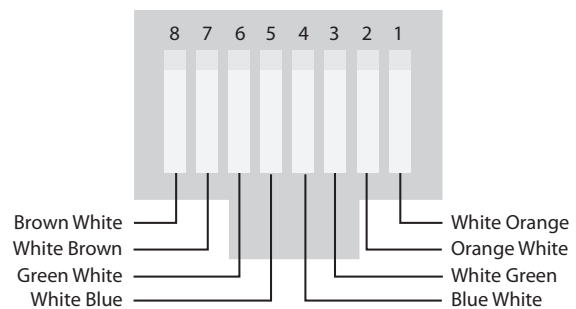

Figure 13. RS232 DB9 pin numbering

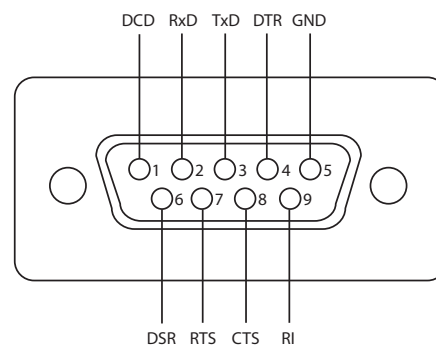

Table 3. RS232 RJ45 to RS232 DB9 pin definitions

Colour	RJ45	DB9
White-Orange	1 (CTS)	7 (RTS)
Orange	2 (RTS)	8 (CTS)
White-Green	3 (RXD)	3 (TXD)
Blue	4 (TXD)	2 (RXD)
White-Blue	5 (GND)	5 (GND)
Green	6 (DSR)	4 (DTR)
White-Brown	7 (DCD)	4 (DTR)
Brown	8 (DTR)	6 (DSR)

Figure 14. RJ45-DB9 cable



## LAN / WAN Port

As standard, the QUARTZ Series is supplied with 2 x 10/100Mb LAN connections. Optionally, the QUARTZ router can be supplied with 1 x 10/100Mb LAN and 1 x WAN connections.

These connections can be used to connect the router directly to a computer.

Figure 15. QUARTZ LAN / WAN Connection

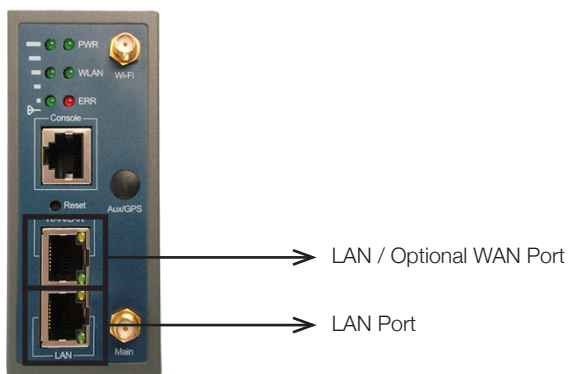

## Input/Output

This connector provides a general purpose multi-way interface for the user to access additional functionality within the QUARTZ router.

Figure 16. Input/Output

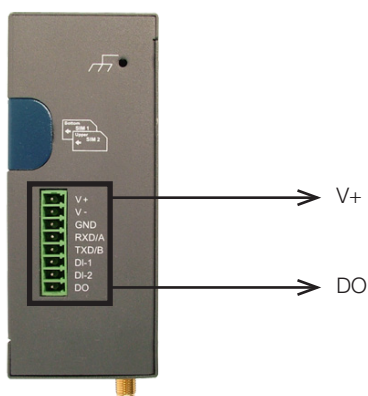

Table 4. QUARTZ Series Input/Output

Name	Direction	Description
V+	Input	Power Positive (+12V DC)
V-	Input	Power Ground (0V)
GND	Input/Output	RS232 Signal Ground
RXD/A	Input	RS232 Debug Receive
TXD/B	Output	RS232 Debug Transmit
DI-1	Input	Direct Input 1
DI-2	Input	Direct Input 2
DO	Output	Direct Output

## SIM Socket

The QUARTZ Series supports fixed SIMs locked to a network and roaming SIMs which can operate on more than one network within the home country. This allows for least cost routing for roaming mobile data and machine to machine applications where signal strength is variable in any given area and network selection is required.

The QUARTZ also supports global roaming SIMs which will work with any network it can detect, at home or abroad and can be chosen for best performance.

The QUARTZ routers can be either single or dual SIM, supporting 1.8/3/5V with automatic SIM detection.\*

Figure 17. SIM holder

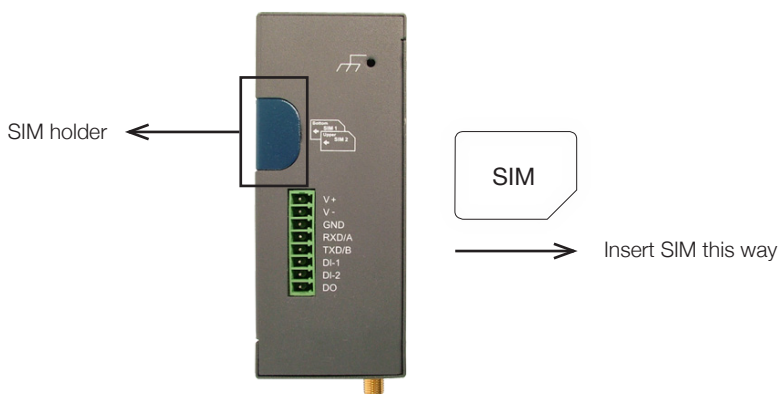

## SIM Requirements

SIM services available for the QUARTZ series include:

- » 3G UMTS (800/850, 900, 1900, 2100MHz)
- » SMS
- » 4G LTE (800, 900, 1800, 1900, 2100, 2600MHz)

Figure 18. SIM card dimensions

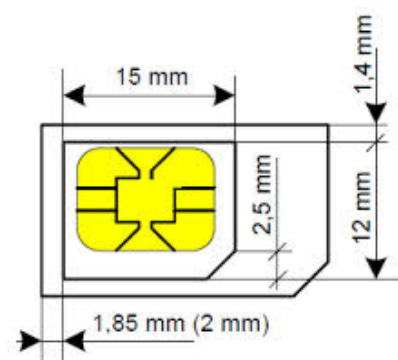

\*To insert SIM card, remove blue protective shield and insert. Replace shield once SIM/s are inserted.

## Antenna Connectors

Figure 19. Antenna connectors

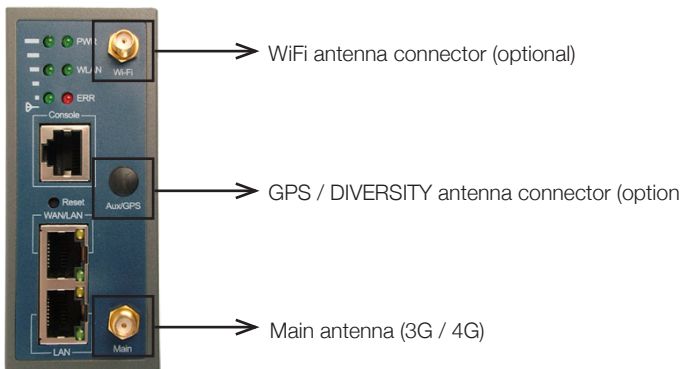

Figure 20. QUARTZ Antennas\*



### Antenna Placement

When in service the antenna should be placed away from electronic devices or other antennas. The recommended minimum distance between adjacent antennas, operating on a similar radio band, is at least 50cm.

### Antenna Connection Cable

If a cable is used to connect the antenna to the router this cable must be a high quality low loss cable. The cable and any connectors used should have 50 ohms impedance.

\*Antennas only supplied when QUARTZ is purchased with accessories.



## Main Antenna

A female SMA connector is provided to allow connection of 3G / LTE. For optimum performance the antenna assembly connected to this router is required to have the following characteristics:

- » For 3G UMTS operation specified operation in the following bands: UMTS 800/850, 900, 1900, 2100MHz
- » For 4G LTE operation specified operation in the following bands: LTE 800, 900, 1800, 1900, 2100, 2600MHz
- » The characteristic impedance on any antenna or cable assembly attached to this router should be 50 ohms
- » The antenna must be capable of handling a minimum of 2W output power
- » The VSWR should be less than 3:1 to avoid damage to the router

## GPS Antenna

A female SMA connector is provided to allow connection of optional GPS. For optimum performance the antenna assembly connected to this router is required to have the following characteristics:

- » For GPS operation specified operation in the following bands: 1575.42 MHz
- » The characteristic impedance on any antenna or cable assembly attached to this router should be 50 ohms
- » The antenna must be capable of handling a minimum of 2W output power
- » The VSWR should be less than 3:1 to avoid damage to the router

## WiFi Antenna

A female SMA connector is provided to allow connection of WiFi. For optimum performance the antenna assembly connected to this router is required to have the following characteristics:

- » For WiFi operation specified operation in the following bands: 2.4GHz
- » The characteristic impedance on any antenna or cable assembly attached to this router should be 50 ohms
- » The antenna must be capable of handling a minimum of 2W output power
- » The VSWR should be less than 3:1 to avoid damage to the router

## GPS

### GPS Performance (QUARTZ-G Variants)

- » Advanced real time hardware correlation engine for enhanced sensitivity (better than -165dBm for A-GPS)
- » Fast Acquisition giving rapid Time-to-First-Fix (TTFF)
- » Capability to monitor up to 28 channel
- » Stand Alone and Assisted mode
- » Integrated LNA

## WiFi

### WiFi Performance (QUARTZ-W Variants)

- » Standard: IEEE 802.11b/g/n
- » WEP, WPA and WPA2 encryption
- » Standard 150Mbps

# Power

## Power Connector

This connector is used for supplying DC power and power ON/OFF signals for the modem. The modem power supply is 5 - 26VDC.

Figure 21. RJ12 power connector

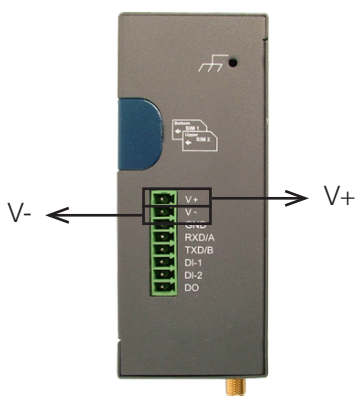

Table 5. QUARTZ Power Input

Name	Description
V+	Power Positive (+12V DC)
V-	Power Ground (0V)

## Power Supply Requirements

A DC power supply must be connected to the power input.

Table 6. Characteristics of power input

	QUARTZ Series
Idle:	80mA @ +12VDC
Communicating (No WiFi):	320mA : +12VDC
Communicating (With WiFi):	600mA @ +12VDC
Power supply:	7.5 - 26VDC

## Switching the Router ON/OFF

### Power on the QUARTZ

The QUARTZ router is automatically powered on when power is supplied.

### Power off the QUARTZ

The QUARTZ router is automatically powered off when power is removed.

### Restart the QUARTZ

Press and hold reset button for at least 5 seconds.

Figure 22. Reset button

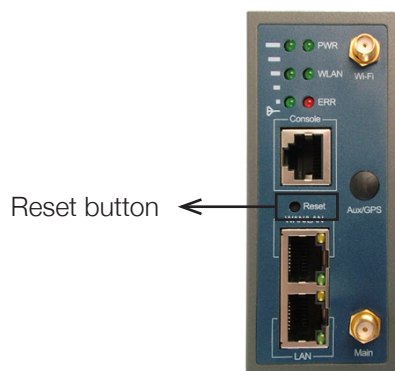

# Installation

## Considerations for Installations Incorporating the QUARTZ

There are several conditions which need to be taken into consideration when designing your application as they might affect the router and its functionality. These are:

**Environmental conditions:** The router must be installed so that the environmental conditions stated such as temperature, humidity and vibration are satisfied. Additionally, the electrical specifications must not be exceeded.

**Signal strength:** The router/antenna has to be placed in a position that ensures sufficient signal strength. To improve signal strength, the antenna can be moved to a more elevated position. Signal strength usually depends on how close the router is to the base station. You must ensure that the location at which you intend to use the router is within the network coverage area. Degradation in signal strength can be the result of a disturbance from another source, for example an electronic device in the immediate vicinity.

When considering the location for the router and antenna placement, you must consider received signal strength as well as cable length as long cable runs can attenuate the received signal strength.

**Connections of components to QUARTZ Series routers:** The system integrator is responsible for the final system solution. If external components are incorrectly designed or installed it may cause radiation limits to be exceeded. For instance, improper cable connections or incorrectly installed antennas can disturb the network and lead to router malfunction.

**Network and subscription:** Before your application is used, you must ensure that your chosen network provides the necessary telecommunication services. Contact your service provider to obtain the necessary information.

- » If you intend to use SMS in the application, ensure this is included in your subscription.

## Power Supply Installations

- » Use a high-quality power supply with short leads. This ensures that the voltages at the connector pins are within the specified range, especially during the maximum peak current of approximately 2A.
- » When the router is powered from a battery or a high current supply, connect a fast 1.25A fuse in line with the positive supply. This protects the power cabling and modem from damage.

## Securing the Router

Before securing the router please take into account the amount of additional space required for the mating connectors and cables that will be used with the router in the application.

- » Where access is restricted, it may be easier to connect all the cables to the modem prior to placing it in the application.

## Safety and Product Care

Please read the information on this page and **page 21** 'Installation' before you begin your system integration.

### General Precautions

- » The QUARTZ series routers are a standalone item designed for indoor use only. For use outside it must be installed in a weatherproof enclosure.
- » Do not exceed the environmental and electrical limits as specified.
- » Avoid exposing the router to lit cigarettes, naked flames or to extreme hot or cold temperatures.
- » Never try to dismantle the router. There are no components inside the router that can be serviced by the user. If you attempt to dismantle the router, you will invalidate the warranty.
- » The QUARTZ series router must not be installed or located where the surface temperature of the enclosure may exceed 85°C.
- » All cables connected to the QUARTZ series routers must be secured or clamped, immediately adjacent to the routers connectors, to provide strain relief and to avoid transmitting excessive vibration to the router in the installation.
- » To protect power supply and to meet the fire safety requirements when the router is powered from a battery or a high current supply, connect a fast 1.25A fuse in line with the positive supply.
- » Do not connect any incompatible component or product to the QUARTZ series router.

### SIM Card Precautions

Before handling the SIM card in your application, ensure that you have discharged any static electricity. Use standard precautions to avoid electrostatic discharges.

- » When designing a QUARTZ series router into your application, the accessibility of the SIM card should be taken into account so that it can be removed or changed.
- » We always recommend that you have the SIM card protected by a PIN code. This will ensure that the SIM card cannot be used by an unauthorized person.

## Antenna Precautions

If the antenna is to be mounted outside, always consider the risk of a lightning strike. Follow the instructions provided by the antenna manufacturer. In addition please observe the following:

- » Never connect more than one modem to a single antenna. The router can be damaged by radio frequency energy from the transmitter of another router.
- » With all mobile station equipment, the antenna of the router emits radio frequency energy. To avoid EMI (electromagnetic interference) you must determine if the application or equipment in the application's proximity, needs further protection against radio emission and the disturbances it might cause. Protection is secured either by shielding the surrounding electronics or by moving the antenna away from the electronics and external signal cables.
- » The router and antenna may be damaged if either come into contact with ground potentials other than the ground potential used in your application. Beware, ground potentials can vary significantly between hardware platforms.

## Exposure to RF Energy

There has been some public concern about possible health effects of using GSM equipment in close proximity to a person or body. Although research on health effects from RF energy has focused for many years on the current RF technology, research has begun on new radio technologies, such as GSM and UMTS. After existing research had been reviewed, and after compliance to all applicable safety standards has been tested, it has been concluded that the ZETA series modem is fit for use.

If you are concerned about exposure to RF energy, there are a number of things you can do to minimize exposure. Obviously, limiting the duration of time near a device will reduce your exposure to RF energy. In addition, you can reduce RF exposure by operating your modem efficiently by adhering to the following guidelines:

**Electronic devices:** Most electronic equipment, for example in hospitals and motor vehicles is shielded from RF energy. However, RF energy may affect some malfunctioning or improperly shielded electronic equipment.

**Vehicle electronic equipment:** Check your vehicle manufacturer's representative to determine if any on board electronic equipment is adequately shielded from external RF energy.



**Medical electronic equipment:** Consult the manufacturer of any personal medical devices (such as pacemakers, hearing aids, etc.) to determine if they are adequately shielded from external RF energy.

Turn your modem OFF in health care facilities when any regulations posted in the area instruct you to do so. Hospitals or health care facilities may be using RF monitoring equipment.

**Aircraft:** Turn your modem OFF before boarding any aircraft. To prevent possible interference with aircraft systems, Federal Aviation Administration (FAA) regulations require you to have permission from a crewmember to use your modem equipment whilst the plane is on the ground. To prevent interference with cellular systems, local RF regulations prohibit using your modem whilst in the air.

**Blasting areas:** To avoid interfering with blasting operations, turn your modem OFF when in a “blasting area” or in areas posted: “turn off two-way radio”. Construction crew often uses remote control RF devices to set off explosives.

**Potentially explosive atmospheres:** Turn your modem OFF when in any area with a potentially explosive atmosphere. It is rare, but your routers or their accessories could generate sparks. Sparks in such areas could cause an explosion or fire resulting in bodily injury or even death.

Areas with a potentially explosive atmosphere are often, but not always, clearly marked. They include fuelling areas such as petrol stations, below deck on boats, fuel or chemical transfer or storage facilities and areas where the air contains chemicals or particles, such as grain, dust or metal powders. Do not transport or store flammable gas, liquid or explosives, in the compartment of your vehicle, which contains your modem or accessories. Before using your modem in a vehicle powered by liquefied petroleum gas (such as propane or butane) ensure that the vehicle complies with the relevant fire and safety regulations of the country in which the vehicle is to be used.

## Safety Recommendations

### PLEASE READ CAREFULLY

Be sure the use of this product is allowed in the country intended and the environment required. The use of this product may be dangerous and has to be used with caution in the following areas:

- » Where it can interfere with other electronic devices in environments such as hospitals, airports, aircrafts, etc
- » Where there is risk of explosion such as gasoline stations, oil refineries, gas works etc

It is responsibility of the user to enforce the country regulation and the specific environment regulation.

Do not disassemble the product, any mark of tampering will compromise the warranty.

We recommend following the instructions of this hardware user guide for the correct wiring of the product. The product has to be supplied with a stabilized voltage source and the wiring has to conform to the security and fire prevention regulations.

The product has to be handled with care, avoid any direct contact with the pins because electrostatic discharge may damage the product. The same precautions have to be observed for the SIM card installation.

The system integrator is responsible for the complete functionality of the final product. Therefore, care has to be taken with the external components used with the module, as well as any installation issue.

Should there be any doubt, please refer to the technical documentation and the regulations in force. Every module has to be equipped with a suitable antenna with characteristics which match the product requirements.

The antenna has to be installed with care in order to avoid any interference with other electronic devices and has to guarantee a minimum distance from the body (20 cm). In case this requirement cannot be satisfied, the system integrator has to assess the final product against the SAR regulation EN 50360.

## Approvals

- » **CE** - European Conformity
- » **RoHS** - Restriction of the Use of Certain Hazardous Substances Compliant
- » **CCC** - China Compulsory Certificate

## Disclaimer

The information contained in this document is proprietary to Siretta. Siretta has made every effort to ensure that the accuracy of the information contained within this document is accurate. Siretta does not make any warranty as to the information contained within this document and does not accept any liability for any injury, loss or damage of any kind incurred by the use of this information.

Siretta does not take responsibility for any application developed using the modem characterized in this document and notes that any application of this modem must comply with the safety standards of the applicable country and comply with the relevant wiring rules. Siretta reserves the right to make modifications, additions and deletions to this document due to typographical errors, inaccurate information, or improvements to equipment at any time and without notice. Such changes will be incorporated into new editions of this document.

All rights reserved.

© 2015 Siretta Ltd

## Definitions

Term	Definition
3G	3rd Generation Mobile Telecommunications
4G	4th Generation Mobile Telecommunications
CDMA	Code Division Multiple Access
DHCP	Dynamic Host Configuration Protocol
DNS	Domain Name System
GPS	Global Positioning System
LAN	Local Area Network
LED	Light Emitting Diode
LTE	Long-Term Evolution
M2M	Machine to Machine Communication
NTP	Network Time Protocol
RF	Radio Frequency
R-UIM	Removable User Identity Module
SIM	Subscriber Identity Module
SMA	Subminiature Version A
SNMP	Simple Network Management Protocol
UMTS	Universal Mobile Telecommunications System
VPN	Virtual Private Network
WAN	Wide Area Network
WCDMA	Wideband Code Division Multiple Access
WLAN	Wireless Local Area Network

# Become A Distributor

Siretta is currently growing its worldwide distributor and reseller base. Distributors can benefit from an excellent product range, marketing and technical support, along with the widest range of Antennas, Connectors, Cable Assemblies and Wireless Terminals.



**sales** +44 (0)118 976 9014  
**fax** +44 (0)118 976 9020  
**accounts** +44 (0)118 976 9069  
**email** sales@siretta.co.uk

**[www.siretta.co.uk](http://www.siretta.co.uk)**

Siretta Ltd  
Basingstoke Road  
Spencers Wood  
Reading  
Berkshire  
RG7 1PW  
United Kingdom

Company No. 08405712  
VAT Registration No. GB163 04 0349

A member of the Olanca Group Ltd



Rev 1.5 Nov 2015