

SQUARE NUT M05 H WITH POSITION FIXING

Article Nr. 21.1320/4

[See the product on the website](#) →

[Download CAD Files](#) →

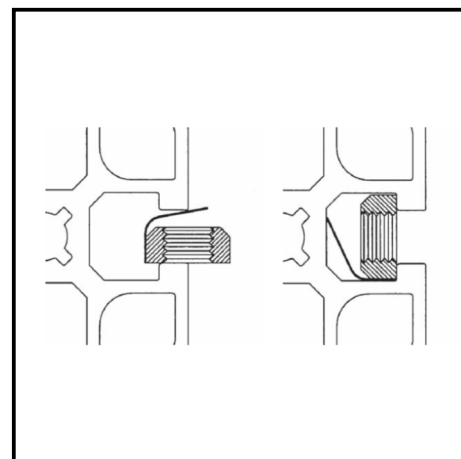
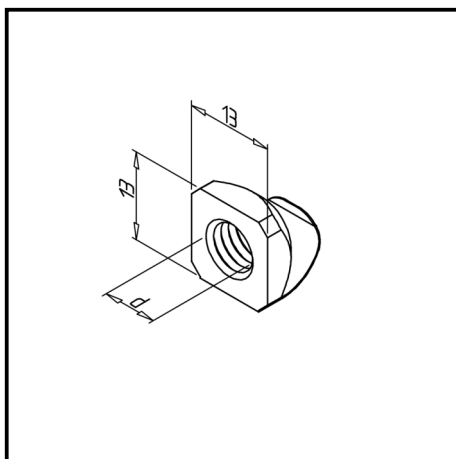
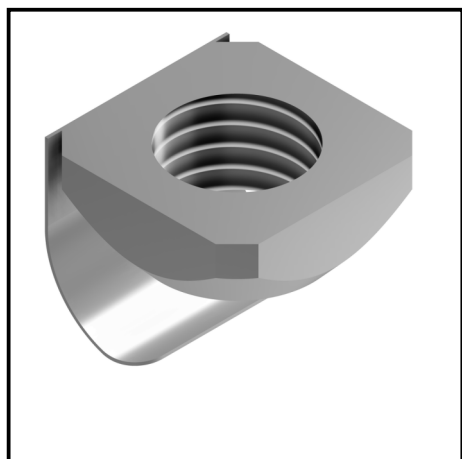

TECHN. DATA / ITEMS SUPPLIED

- Stainless steel
- Thread (d) : M 5
- Weight = 0.005 kg/piece

APPLICATIONS

- Sliding nuts can be swiveled into the profile (series 45) at any point
- The spring plate holds the nut in the desired position

ASSEMBLY

- Mounting by swiveling into the groove