

Premier & Acculase Range Modular Modulatable Lasers

Features

Flexible design accommodating wide range of lens and diode options

High bore sight accuracy on Acculase model

Visible and Infra red versions

Powers up to 100mW

2 Control drivers available:

Linear Control (LC model)

- Linear intensity control
- Analogue modulation

Pulse Width Modulation (PWM model)

- Digital TTL on/off switching
- $< 0.5\mu\text{s}$ rise / fall time

Stable output power

Wide operating temperature

Electrically isolated case

Reverse polarity protection

User adjustable focus

Applications

Graphics Displays

Vision Systems

Telemetry

Dynamic Lighting

Medical

Laboratory Testing

Alignment Systems

Beam Break

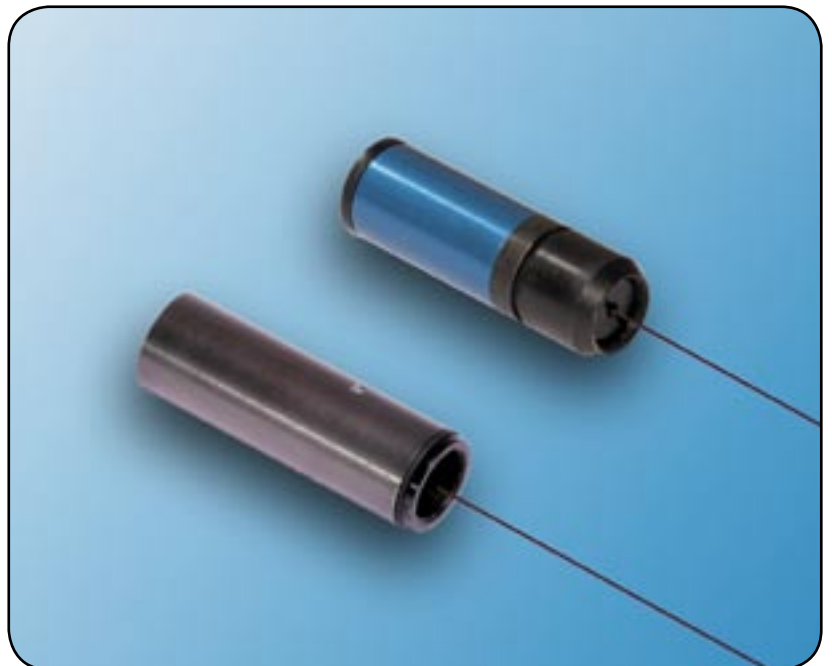

The Premier & Acculase laser diode modules represent the highest level of optical and electrical performance at an economical price, a combination that is unmatched in the marketplace.

Unlike the Premier laser, the Acculase is precision set during manufacture that ensures that the output beam is accurately aligned to the outer sleeve. This allows you fast and simple installation, as well as immediate and consistent alignment, even in the field.

The secret of their superiority is a control circuit design that not only gives you excellent output power stability over time and temperature, but also offers fast, closed-loop modulation with an extinction ratio as high as 10,000:1. Two control circuits are available either the LC (Linear Control) or the PWM (Pulse Width Modulation).

The LC version allows you to control the output intensity linearly by applying a voltage of between 0 to 1 volts, to the control input. The output intensity will faithfully replicate any arbitrary signal you wish to apply within the limits of the laser module's maximum rise and fall time. The input is clamped so that if you were to apply a level greater than 1 volt the output will not increase more than 5% above the factory set limit.

The PWM version allows you to use pulse width modulation of the output intensity from a TTL level input signal, within the limits of the laser module's maximum rise and fall time. You can therefore control the mean intensity of the laser beam simply by changing the mark to space ratio or modulate the laser with coded information.

A wide range of wavelengths, powers and lens options are available, each combination having been carefully selected to provide you optimum performance, while ensuring the laser diode is never over driven.



PRODUCT OVERVIEW

PREMIER-LC & PWM

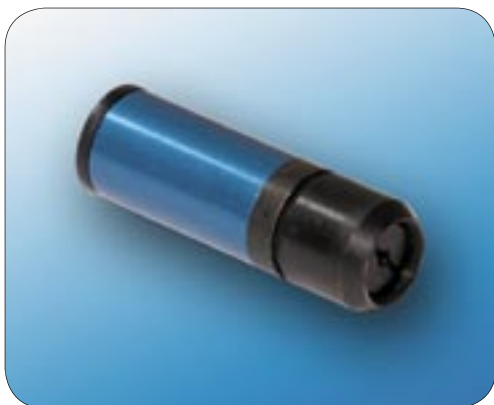

Key Features

- Choice of Visible or I/R Wavelengths
- Powers up to 100mW
- Choice of lenses to provide circular/elliptical beams or lines
- Linear Control or Pulse Width Modulation internal driver board
- Electrical isolated case
- Reverse Polarity protected

Diameter 15 mm

Length 47 mm

ACCULASE-LC & PWM

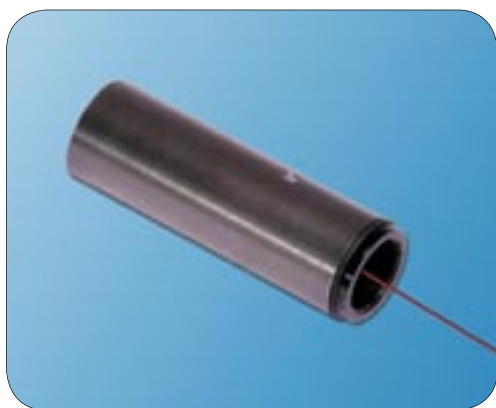

Key Features

- High pointing accuracy < 1mRad
- Choice of Visible or I/R Wavelengths
- Powers up to 100mW
- Choice of lenses to provide circular/elliptical beams or lines
- Linear Control or Pulse Width Modulation internal driver board
- Electrical isolated case
- Reverse polarity protected

Diameter 15 mm

Length 47.5 mm

LENS OPTIONS

3 standard user adjustable lens types are available for the Premier and Acculase range. These are as follows:

S Lens: Produces elliptical collimated beam or focused spot

C2 Lens: Produces circular collimated beam or elliptical focused spot

L8 Lens: Produces Gaussian line with full fan angle of typically 16 degrees. Please note other fan angles are available on request.

STANDARD WAVELENGTHS AND POWER OPTIONS

635 nm	1, 3, 5, 10, 15, 35 mW
650 nm	1, 5, 10 mW
660 nm	20, 30, 35, 50 mW
670 nm	1, 3, 5, 10 mW
685 nm	20, 50 mW
780 nm	5, 20 mW
785 nm	35, 50, 75, 90 mW
808 nm	100 mW
850 nm	1, 3, 5 mW
Custom	Please call for further details

Please note wavelength tolerance can vary typically by ± 10 nm.

Not all the powers are available with all the lens options

STANDARD DRIVER TYPES

Two driver boards are available for the Premier & Acculase laser either a Linear Control or Pulse Width Modulation control.

• LINEAR INTENSITY & ANALOGUE MODULATION CONTROL (LC MODEL)

User adjustable intensity control

Via the yellow control lead output power intensity may be linearly controlled from zero to the maximum factory set value. This may be achieved using a simple resistor or by applying a control voltage between 0 and 1V where 0V dc is off, +1 Vdc is maximum. This control is linear so an input of 0.5V would produce an output intensity of half maximum.

See power adjustment curve below.

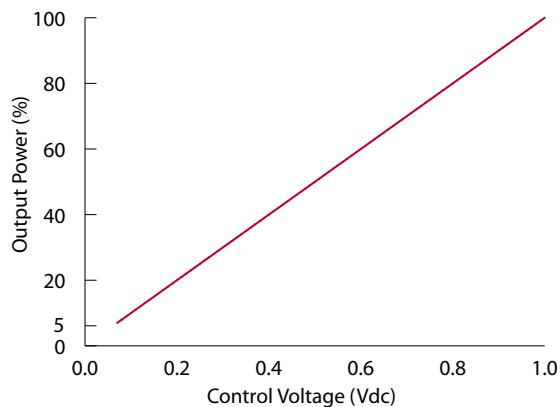

Power adjustment curve

Modulation

Using the yellow control lead the laser may be modulated by using an external signal. The required voltage range is 0 to +1 Vdc (to set the maximum intensity), frequency range is DC to 300 KHz. Please note: applying more than 1 V does not increase the power above maximum but it can reduce the maximum frequency of modulation.

Please note: Intensity control and modulation functions may be used together.

• PULSE WIDTH MODULATION TTL DIGITAL CONTROL (PWM MODEL)

The Acculase / Premier laser is also available with a TTL driver board that allows the unit to be gated on and off, or pulse-width modulated at TTL voltage levels via the yellow control lead.

Rise Time: < 0.5 μ s *

Fall Time: < 0.5 μ s *

* = varies with model

EXTRA OPTIONS

Heavy Duty Mounting clamp

The optional heavy duty mounting clamp allows the Premier & Acculase range to be securely fixed at any required direction or angle. The base plate has a series of threaded holes which allows the clamp to be fixed directly onto a machine or workbench.

Swivel Mount Clamp

The optional lower cost swivel clamp allows the Premier & Acculase to be mounted securely. It offers the user up and down movement as well as $\pm 45^\circ$ swivel. The base plate has a series of holes which allows the clamp to be fixed directly onto a machine or workbench



MECHANICAL SPECIFICATIONS

	Acculase-LC	Acculase-PWM	Premier-LC	Premier-PWM
Mass	15 grams		17 grams	
Dimensions	15 mm diameter by 47.5 mm		15 mm diameter by 47 mm	
Housing	Anodised Aluminium			
Isolated Body	Yes			
Lead length	2000 mm (Other Lead Lengths available on request)			
Connector type	JST PHR4 4pin			

OPTICAL SPECIFICATIONS

Diode Power	1 mW to 100 mW *			
Power Stability vs case Temp	0.005 % per °C			
Wavelength	635 nm to 850 nm			
Beam Size at Aperture	*			
Beam Divergence	*			
Pointing Accuracy	<1 mrad		5 mrad	
Pointing Stability vs Temp	0.005 mrad per °C			

ENVIRONMENTAL SPECIFICATIONS

Operating Case Temperature	-10°C to +50°C *			
Storage temp	-10°C to +80°C			
Operating Humidity (%RH)	90 non condensing			
MTTF at 25°C	>30,000 hours *			

ELECTRICAL SPECIFICATIONS

Input Voltage (Red Lead - Pin 1)	+3.3 Vdc to +6 Vdc	+5.0 Vdc ± 5%	+3.3 Vdc to +6 Vdc	+5.0 Vdc ± 5%
Input Voltage (Black Lead - Pin 2)	0 Vdc			
Operating Current Drive Circuit	< 3 mA			
Operating Current	Varies with Laser diode type and Temperature			
Reverse -Polarity protection	Yes			
Rise and fall times	1 µs	<0.5 µs	1 µs	<0.5 µs
Frequency range	DC to 300 KHz	DC to 1 MHz	DC to 300 KHz	DC to 1 MHz
Control Modulation Voltage Range (Yellow Lead - Pin 3) LC Version	0 - 1 V (see chart)		0 - 1 V (see chart)	
Modulation input Voltage (Yellow Lead - Pin 3) PWM Version	< 0.4 V = Off > 2 V = On		< 0.4 V = Off > 2 V = On	
TTL Enable (Blue lead - Pin 4)	N/A	Low = Off High = On	N/A	Low = Off High = On

* = *Varies with Laser Diode type*

Specifications are typical at 25°C unless otherwise stated

DIMENSIONAL DRAWINGS

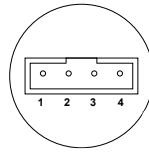
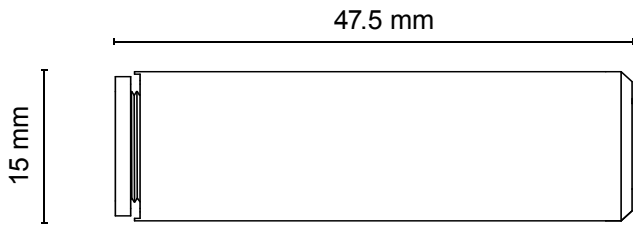

- Pin 1 - Red
- Pin 2 - Black
- Pin 3 - Yellow
- Pin 4 - LC = Green / Yellow
- Pin 4 - PWM = Blue

ACCULASE-LC & PWM

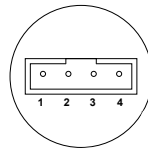
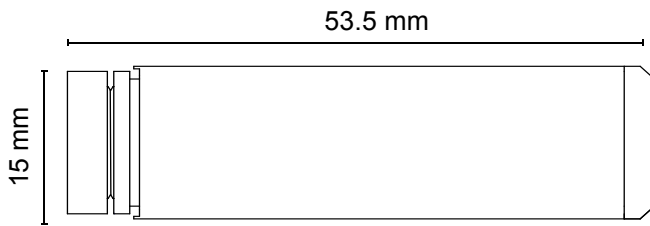

- Pin 1 - Red
- Pin 2 - Black
- Pin 3 - Yellow
- Pin 4 - LC = Green / Yellow
- Pin 4 - PWM = Blue

ACCULASE-LC & PWM WITH L8 LINE LENS

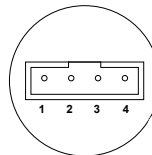
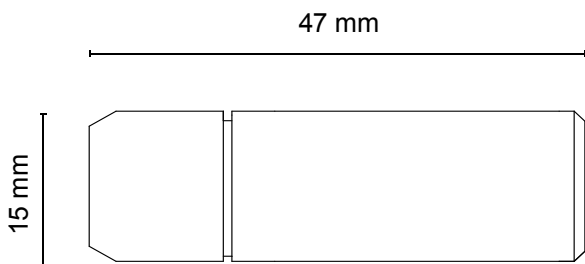

- Pin 1 - Red
- Pin 2 - Black
- Pin 3 - Yellow
- Pin 4 - LC = Green / Yellow
- Pin 4 - PWM = Blue

PREMIER-LC & PWM

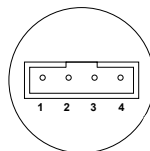
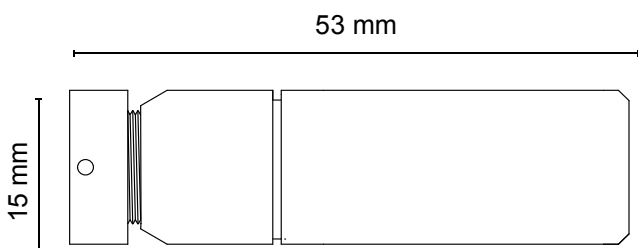

- Pin 1 - Red
- Pin 2 - Black
- Pin 3 - Yellow
- Pin 4 - LC = Green / Yellow
- Pin 4 - PWM = Blue

PREMIER-LC & PWM WITH L8 LINE LENS

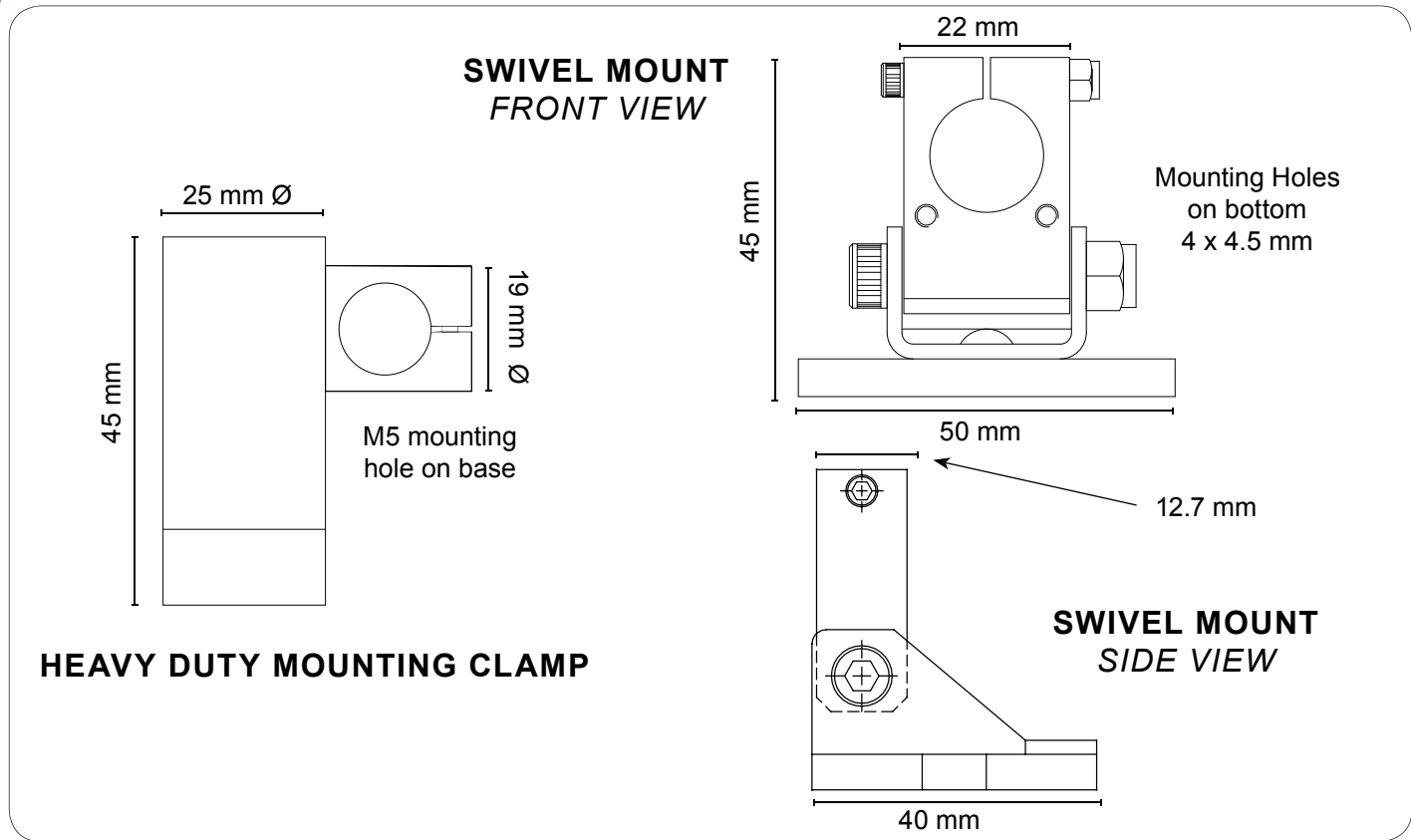

LASER SAFETY

Our lasers are compliant to IEC 60825-1 standards. The lasers fall within one of the following classifications depending on power and wavelength. The examples of the labels supplied with the units are shown below.

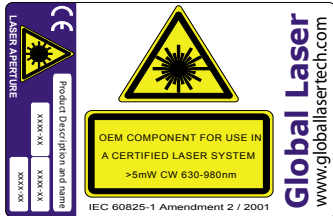

OEM Laser Label

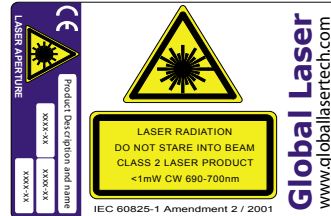

Class 2 / 2M Laser Label

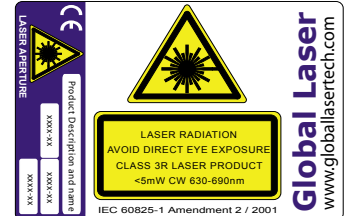

Class 3R Laser Label

QUALITY & WARRANTY

The Premier & Acculase range is supplied with a 12 month parts and labour warranty. Our manufacturing operations are certified to ISO9001.



Please note: Global Laser reserve the right to change descriptions and specifications without notice



Cwmtilly Industrial Estate
Abertillery, Gwent, UK. NP13 1LZ

T: +44 (0)1495 212213
F: +44 (0)1495 322322
E: sales@globallasertech.com
www.globallasertech.com

For further information about the Premier & Acculase range you can contact your local distributor or you can contact Global Laser in the UK.

Your Local Distributor Is: