

**SIRIUS**  
**Elektronische Zeitrelais**  
**Electronic Time Relays**  
**Relais tempoisés électroniques**  
**Relés de tiempo electrónicos**  
**Relè elettronici a tempo**  
**Relés temporizador eletrônicos**  
**Elektronik zaman rölesi**  
**Электронное реле с выдержкой времени**



<b>Betriebsanleitung</b> <b>Istruzioni operative</b>	<b>Operating Instructions</b> <b>Instruções de Serviço</b>	<b>Instructions de service</b> <b>İşletme kılavuzu</b>	<b>Instructivo</b> <b>Инструкция по эксплуатации</b>
---	---	---	---

	<b>Deutsch</b>	<b>English</b>	<b>Français</b>	<b>Español</b>
	Vor der Installation, dem Betrieb oder der Wartung des Geräts muss diese Anleitung gelesen und verstanden werden.	Read and understand these instructions before installing, operating, or maintaining the equipment.	Ne pas installer, utiliser ou intervenir sur cet équipement avant d'avoir lu et assimilé les présentes instructions et notamment les conseils de sécurité et mises en garde qui y figurent.	Leer y comprender este instructivo antes de la instalación, operación o mantenimiento del equipo.
	<b>⚠ GEFAHR</b>	<b>⚠ DANGER</b>	<b>⚠ DANGER</b>	<b>⚠ PELIGRO</b>
	<b>Gefährliche Spannung. Lebensgefahr oder schwere Verletzungsgefahr.</b> Vor Beginn der Arbeiten Anlage und Gerät spannungsfrei schalten.	<b>Hazardous voltage. Will cause death or serious injury.</b> Turn off and lock out all power supplying this device before working on this device.	<b>Tension électrique. Danger de mort ou risque de blessures graves.</b> Mettez hors tension avant d'intervenir sur l'appareil.	<b>Tensión peligrosa. Puede causar la muerte o lesiones graves.</b> Desconectar la alimentación eléctrica antes de trabajar en el equipo.
	<b>VORSICHT</b>	<b>CAUTION</b>	<b>PRUDENCE</b>	<b>PRECAUCIÓN</b>
	Eine sichere Gerätefunktion ist nur mit zertifizierten Komponenten gewährleistet.	Reliable functioning of the equipment is only ensured with certified components.	La sécurité de fonctionnement de l'appareil n'est garantie qu'avec des composants certifiés.	El funcionamiento seguro del aparato sólo está garantizado con componentes certificados.

	<b>Italiano</b>	<b>Português</b>	<b>Türkçe</b>	<b>Русский</b>
	Leggere con attenzione queste istruzioni prima di installare, utilizzare o eseguire manutenzione su questa apparecchiatura.	Ler e compreender estas instruções antes da instalação, operação ou manutenção do equipamento.	Cihazın kurulumundan, çalıştırılmasından veya bakıma tabi tutulmasından önce, bu kılavuzun okunmuş ve anlaşılmiş olması gerekmektedir.	Перед установкой, вводом в эксплуатацию или обслуживанием устройства необходимо прочесть и понять данное руководство.
	<b>⚠ PERICOLO</b>	<b>⚠ PERIGO</b>	<b>⚠ TEHLİKE</b>	<b>⚠ ОПАСНО</b>
	<b>Tensione pericolosa. Può provocare morte o lesioni gravi.</b> Scollegare l'alimentazione prima di eseguire interventi sull'apparecchiatura.	<b>Tensão perigosa. Perigo de morte ou ferimentos graves.</b> Desligue a corrente antes de trabalhar no equipamento.	<b>Tehlikeli gerilim. Ölüm tehlikesi veya ağır yaralanma tehlikesi mevcuttur.</b> Çalışmalara başlamadan önce, sistemin ve cihazın enerjisini kesiniz.	<b>Опасное напряжение. Опасность для жизни или возможность тяжелых травм.</b> Перед началом работ отключить подачу питания к установке и к устройству.
	<b>CAUTELA</b>	<b>CUIDADO</b>	<b>ÖNEMLİ DİKKAT</b>	<b>ОСТОРОЖНО</b>
	Il funzionamento sicuro dell'apparecchiatura è garantito soltanto con componenti certificati.	O funcionamento seguro do aparelho apenas pode ser garantido se forem utilizados os componentes certificados.	Cihazın güvenli çalışması ancak sertifikalı bileşenler kullanılması halinde garanti edilebilir.	Безопасность работы устройства гарантировано только при использовании сертифицированных компонентов.

<b>Technical Assistance:</b>	Telephone: +49 (0) 911-895-5900 (8° - 17° CET) E-mail: <a href="mailto:technical-assistance@siemens.com">technical-assistance@siemens.com</a> Internet: <a href="http://www.siemens.de/lowvoltage/technical-assistance">www.siemens.de/lowvoltage/technical-assistance</a>	Fax: +49 (0) 911-895-5907
<b>Technical Support:</b>	Telephone: +49 (0) 180 50 50 222	

<b>⚠ DANGER</b>	<b>⚠ PELIGRO</b>
<b>Hazardous voltage.</b> Will cause death or serious injury. Disconnect power before working on equipment.	<b>Tensión peligrosa.</b> Puede causar la muerte o lesiones graves. Desconectar la alimentación eléctrica antes de trabajar en el equipo.

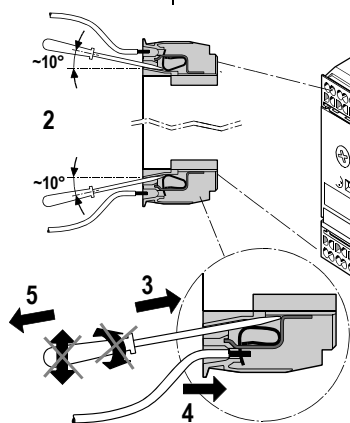
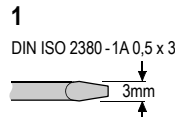
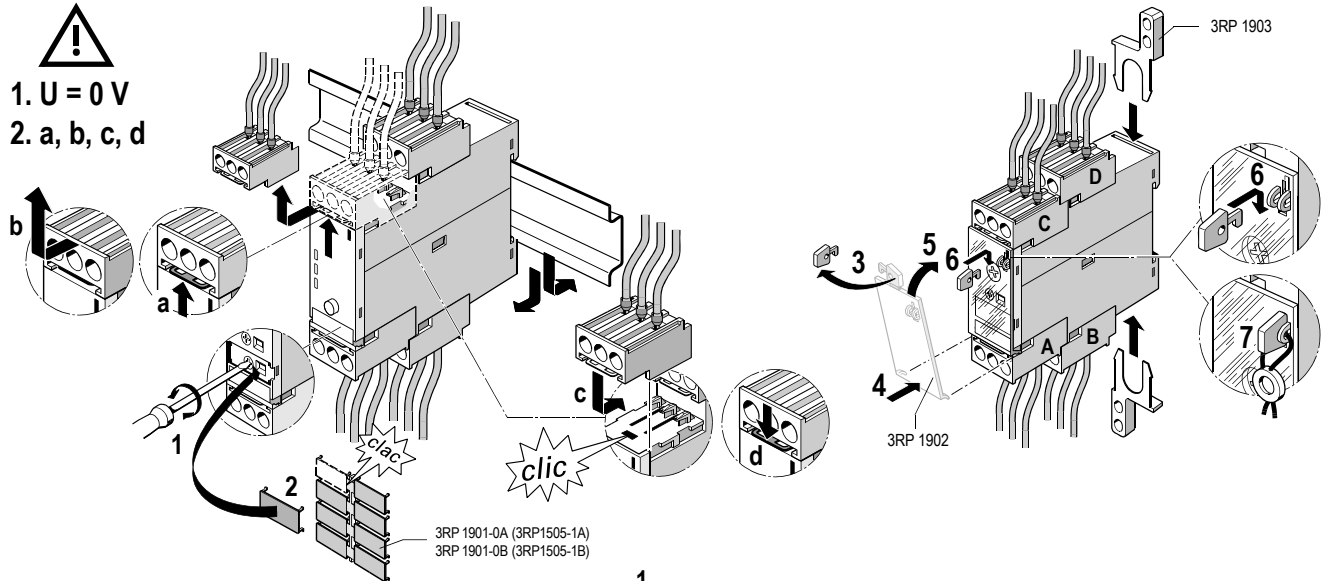

	3RP15..-1....	3RP15..-2....
	0,8 ... 1,2 Nm 7 to 10.3 lbf-in	—
$\varnothing$ 5 ... 6 mm / PZ2	—	—
	1 x 0,5 ... 4,0 mm <sup>2</sup> 2 x 0,5 ... 2,5 mm <sup>2</sup>	2 x 0,25 ... 1,5 mm <sup>2</sup>
	2 x 0,5 ... 1,5 mm <sup>2</sup> 1 x 0,5 ... 2,5 mm <sup>2</sup>	2 x 0,25 ... 1,5 mm <sup>2</sup>
	—	2 x 0,25 ... 1,5 mm <sup>2</sup>
<b>AWG</b>	2 x 20 to 14	2 x 24 to 16

**Hinweis / Note:**

- A, B, C, D:
- Kodiert
- Coded
- Codé
- Cifrado
- Codificato
- Codificado
- Kodlanmış
- Закодировано

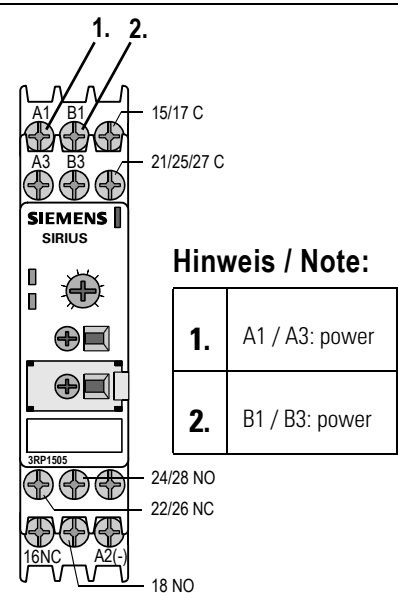

**Hinweis / Note:**

1.	A1 / A3: power
2.	B1 / B3: power

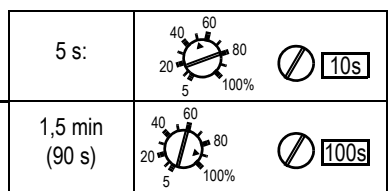
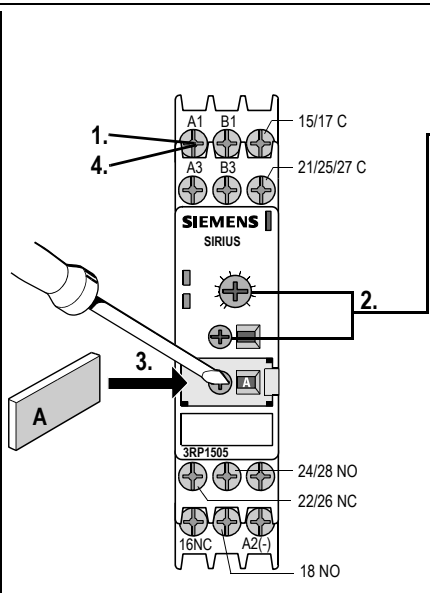

1.	A1 / A3: power OFF
2.	40 60 80 100% 10m
3.	3RP1505
4.	A1 / A3: power ON

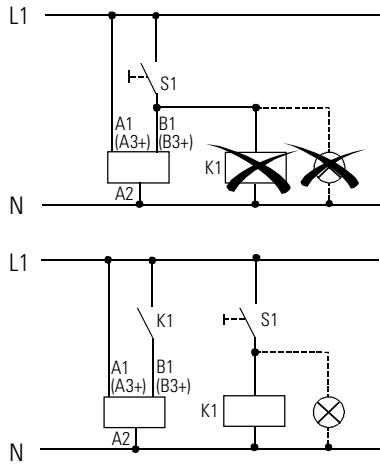

**3RP15...R30**  $U_s = AC/DC 48 V$   
**3RP15...Q30**  $U_s = AC/DC 24 V$   
**3RP15...P30**  $U_s = AC/DC 24 V$   
**3RP15...M20**  $U_s = AC 200 \dots 240 V$

$U_s = AC/DC 60 V$   
 $U_s = AC 100 \dots 127 V$   
 $U_s = AC 200 \dots 240 V$   
 $U_s = AC 380 \dots 440 V$

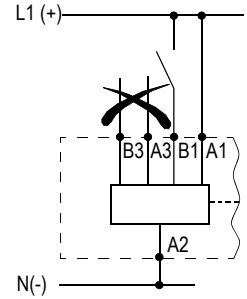
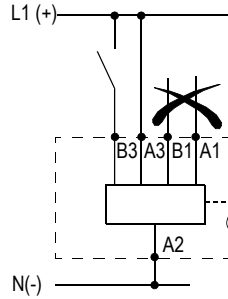

**3RP15...A40**  $U_s = DC 12 V$   
**3RP15...W30**  $U_s = AC/DC 24 \dots 240 V$   
**3RP15...T20**  $U_s = AC 400 \dots 440 V$   
**3RP15...P20**  $U_s = AC 230 \dots 400 V$

**3RP1540...B3.**  $U_s = AC/DC 24 V$   
**3RP1540...J3.**  $U_s = AC/DC 100 \dots 127 V$   
**3RP1540...N3.**  $U_s = AC/DC 200 \dots 240 V$   
**3RP1540...W31**  $U_s = AC/DC 24 \dots 240 V$

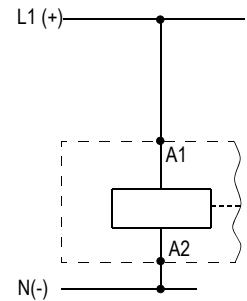
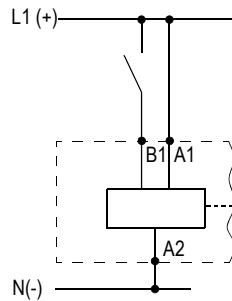

**3RP1505-1A/-2A**  
**3RP1505-1R/-2R** \*)

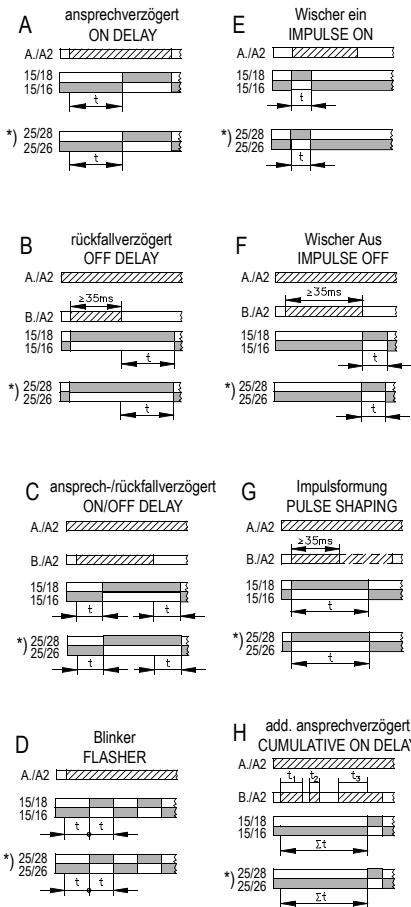

**3RP1505-1B/-2B**

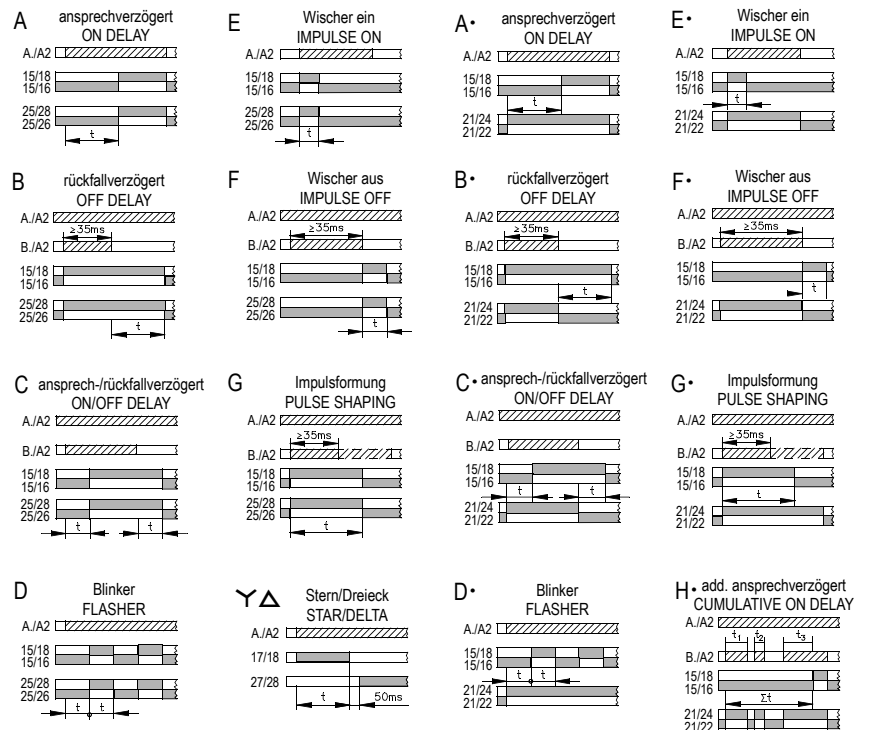

**3RP151./1525-1A/-2A**

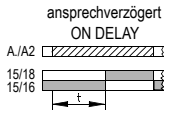

**3RP1525-1B/-2B**

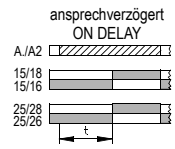

**3RP1527**

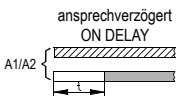

**3RP153.**

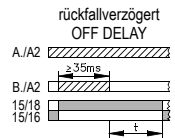

**3RP1540-1A/-2A**

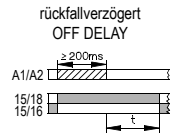

**3RP1540-1B/-2B**

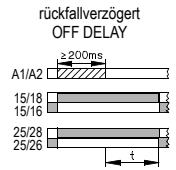

**3RP1555**

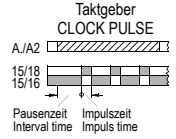

**3RP157.**

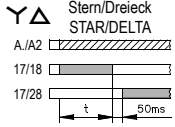

**3RP1560**

