

MARKING:

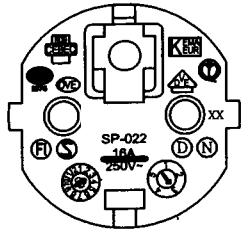

MARKING:

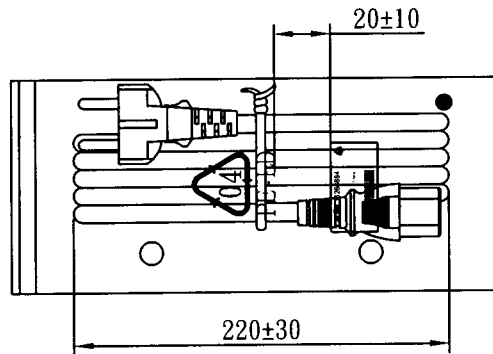
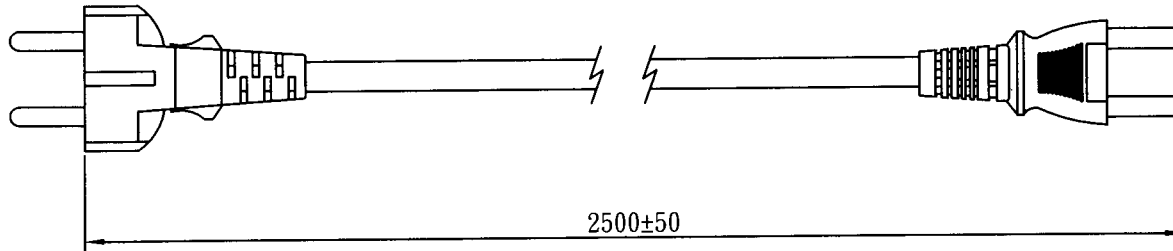
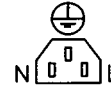
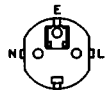
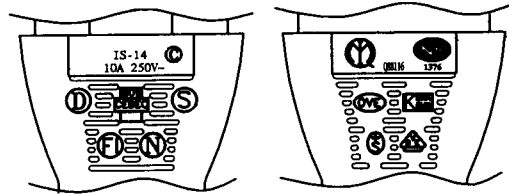

WIRING COLOR:

E: Yellow/Green  
N: Blue  
L: Brown

LENGTH ON CORD: (205-14)

G SGIS <VDE> KEMA-KEUR <VE> <VE> △CEBEC 809  
NF-USE 1346 IEMMEQU H05VV-F 3G 1.0mm<sup>2</sup> 60227 IEC 53 RVV 300/500V  
A003083 3ASL/100 4V-75 V-75(75°C) 250/440V ORDINARY DUTY Q90033 -LF- CE

No	BOM ITEM	Q' TY	P/N
1	SP-023 INSERT(BLACK)	1 pcs	MB023012
2	PVC 45P (SA87, SP-022)	33 g	RPP04512
3	KPR-14 TERMINAL	3 pcs	BBB14000
4	IS-14 INNER BODY	1 set	MI014000
5	PVC 45P (SA87, IS-14)	22 g	RPP04512
6	PE TIE (BLACK, 8 inch)	1 pcs	KBB10008
7	PE BAG	1 pcs	KPR11000
8	LABLE	1 pcs	

NOTE : 1. CORD : EAN-128C  
2 : SCAN CONTENT : 6266694

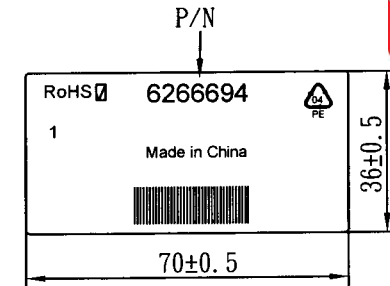

CABLE	H05VV-F 3G 1.0 DENT PRINT CT-12 (BLACK)			
PLUG	SP-022 + IS-14	LENGTH	2500	UNIT mm
CLIENT	NAME	First Connectivity	N/W	0.255323
	P/N	6266694	SG DWG	SR-142461-4
		Design. by	[Signature] 9/26/16	
		Review. by		
		Approval. by	[Signature]	
V24 6C3016 12 250 01				