

### Power Inductors / Wire Wound type

Series: **H**  
 Type: **ELL6RH**  
**ELL6SH**  
**ELL6UH**

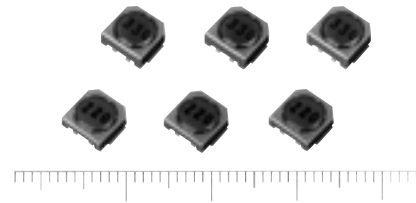

#### ■ Features

- Thin (height 2.5 mm, 3.0 mm)
- Higher reliability in mounting by separating the user terminal and internal connection.
- Large current capability
- RoHS compliant

#### ■ Recommended Applications

- Video, Audio, Mobile communications, Electric battery driven equipment
- As a decoupling choke coil in DC-DC converters

#### ■ Cautionary Notes Regarding Usage in DC-DC converters

- Maximum Dissipation of 1 W.
- Maximum case temperature of 105 °C (Ambient & self-heating temperature)

#### ■ Standard Packing Quantity

- 1000 pcs./Reel

#### ■ Soldering Conditions and Safety Precautions

Please see Data Files.

#### ■ Explanation of Part Numbers

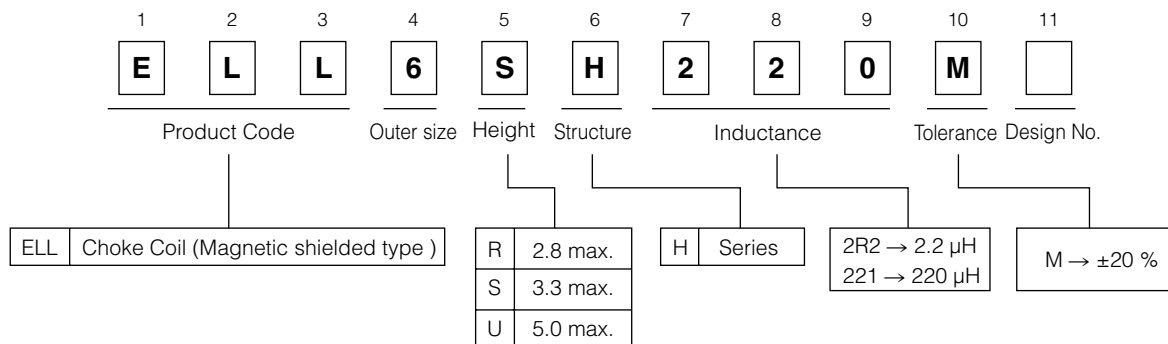

### ■ Dimensions in mm (not to scale)

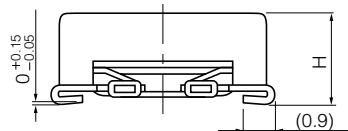
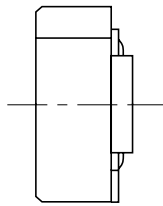
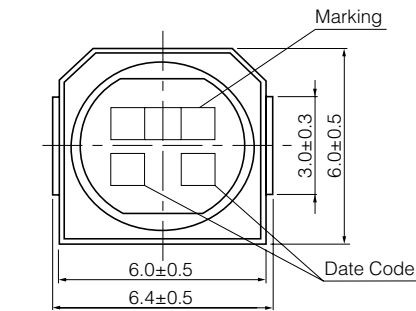

Type	H
ELL6RH	2.5 mm±0.3 mm
ELL6SH	3.0 mm±0.3 mm
ELL6UH	5.0 mm max.

### ■ Connections (Top view)

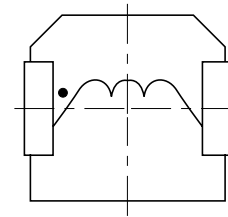

### ■ Recommended Land Pattern in mm (not to scale)

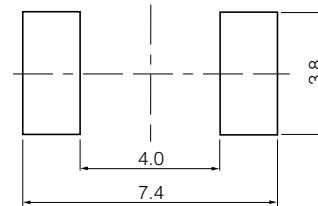

### ■ Standard Parts

Part Number	Inductance (μH) at 100 kHz Tol. ±20 %	RDC (mΩ) at 20 °C Tol. ±20 %		* Rated Current (mA) max.		Marking
		6RH	6SH	6RH	6SH	
ELL6□H1R0M	1.0	19	19	3000	3400	1R0
ELL6□H1R5M	1.5	24	24	2400	3200	1R5
ELL6□H2R0M	2.0	—	26	—	2600	2R0
ELL6□H2R2M	2.2	30	—	2300	—	2R2
ELL6□H2R7M	2.7	39	31	1800	2400	2R7
ELL6□H3R3M	3.3	44	34	1600	2200	3R3
ELL6□H4R7M	4.7	49	42	1580	2000	4R7
ELL6□H5R1M	5.1	56	—	1550	—	5R1
ELL6□H5R6M	5.6	—	49	—	1800	5R6
ELL6□H6R2M	6.2	62	—	1400	—	6R2
ELL6□H6R8M	6.8	—	52	—	1500	6R8
ELL6□H7R5M	7.5	80	—	1250	—	7R5
ELL6□H8R2M	8.2	87	61	1200	1400	8R2
ELL6□H100M	10.0	95	65	1100	1300	100
ELL6□H120M	12.0	130	71	1000	1200	120
ELL6□H150M	15.0	150	96	850	1100	150
ELL6□H180M	18.0	170	130	800	1000	180
ELL6□H220M	22.0	220	140	700	900	220
ELL6□H270M	27.0	260	160	650	800	270
ELL6□H330M	33.0	380	180	600	700	330
ELL6□H390M	39.0	410	240	550	650	390
ELL6□H470M	47.0	480	270	500	600	470
ELL6□H560M	56.0	540	290	450	550	560
ELL6□H680M	68.0	770	520	400	500	680
ELL6□H820M	82.0	870	600	350	450	820
ELL6□H101M	100.0	1000	680	300	400	101
ELL6□H121M	120.0	1500	750	280	370	121
ELL6□H151M	150.0	1800	860	250	350	151
ELL6□H181M	180.0	2000	1300	230	300	181
ELL6□H221M	220.0	2300	1400	200	280	221
ELL6□H271M	270.0	—	2400	—	260	271
ELL6□H331M	330.0	—	2700	—	240	331
ELL6□H391M	390.0	—	2800	—	210	391
ELL6□H471M	470.0	—	3200	—	200	471
ELL6□H561M	560.0	—	3700	—	180	561
ELL6□H681M	680.0	—	4300	—	160	681

\* Current: This indicates the value of current when the inductance is 80% of nominal value or when the case temperature has risen 45 °C.

Design and specifications are each subject to change without notice. Ask factory for the current technical specifications before purchase and/or use. Should a safety concern arise regarding this product, please be sure to contact us immediately.

### Standard Parts

Part No.	Inductance ( $\mu\text{H}$ ) at 100 kHz Tolerance $\pm 20\%$	$R_{DC}$ ( $m\Omega$ ) at 20 °C Tolerance $\pm 20\%$	* Rated Current (mA) max.	Marking
ELL6UH100M	10.0	63	1800	100
ELL6UH120M	12.0	71	1700	120
ELL6UH150M	15.0	79	1600	150
ELL6UH180M	18.0	88	1400	180
ELL6UH220M	22.0	98	1300	220
ELL6UH270M	27.0	110	1200	270
ELL6UH330M	33.0	130	1100	330
ELL6UH390M	39.0	150	1000	390
ELL6UH470M	47.0	160	900	470
ELL6UH560M	56.0	210	800	560
ELL6UH680M	68.0	230	700	680
ELL6UH820M	82.0	260	650	820
ELL6UH101M	100.0	360	600	101
ELL6UH121M	120.0	480	580	121
ELL6UH151M	150.0	680	500	151
ELL6UH181M	180.0	750	470	181
ELL6UH221M	220.0	840	410	221
ELL6UH271M	270.0	1200	370	271
ELL6UH331M	330.0	1360	330	331
ELL6UH391M	390.0	1500	300	391
ELL6UH471M	470.0	1680	270	471
ELL6UH561M	560.0	2530	260	561
ELL6UH681M	680.0	2830	240	681
ELL6UH821M	820.0	3140	200	821
ELL6UH102M	1000.0	3670	180	102

\* Current: This indicates the value of current when the inductance is 70% of nominal value or when the case temperature has risen 45 °C.

### Embossed Carrier Tape Dimensions in mm (not to scale)

