

## P Switch-disconnectors and T Rotary cam switches



**EATON**

*Powering Business Worldwide*

# Eaton's Switch-disconnectors data is available in EPLAN



EPLAN is one of the world's leading design software solutions for machine, plant and panel builders.

You will find in EPLAN all the Eaton's Switch-disconnectors data you need to safely and efficiently build your panel:

- Product images
- Schematic symbols
- 2D DXF Images
- Weights, dimensions, cable size, torque settings, catalogue data, electrical parameters
- List of accessories
- 3D Intelligent step files:
  - Wiring connection points
  - Drill hole patterns
  - Mounting faces

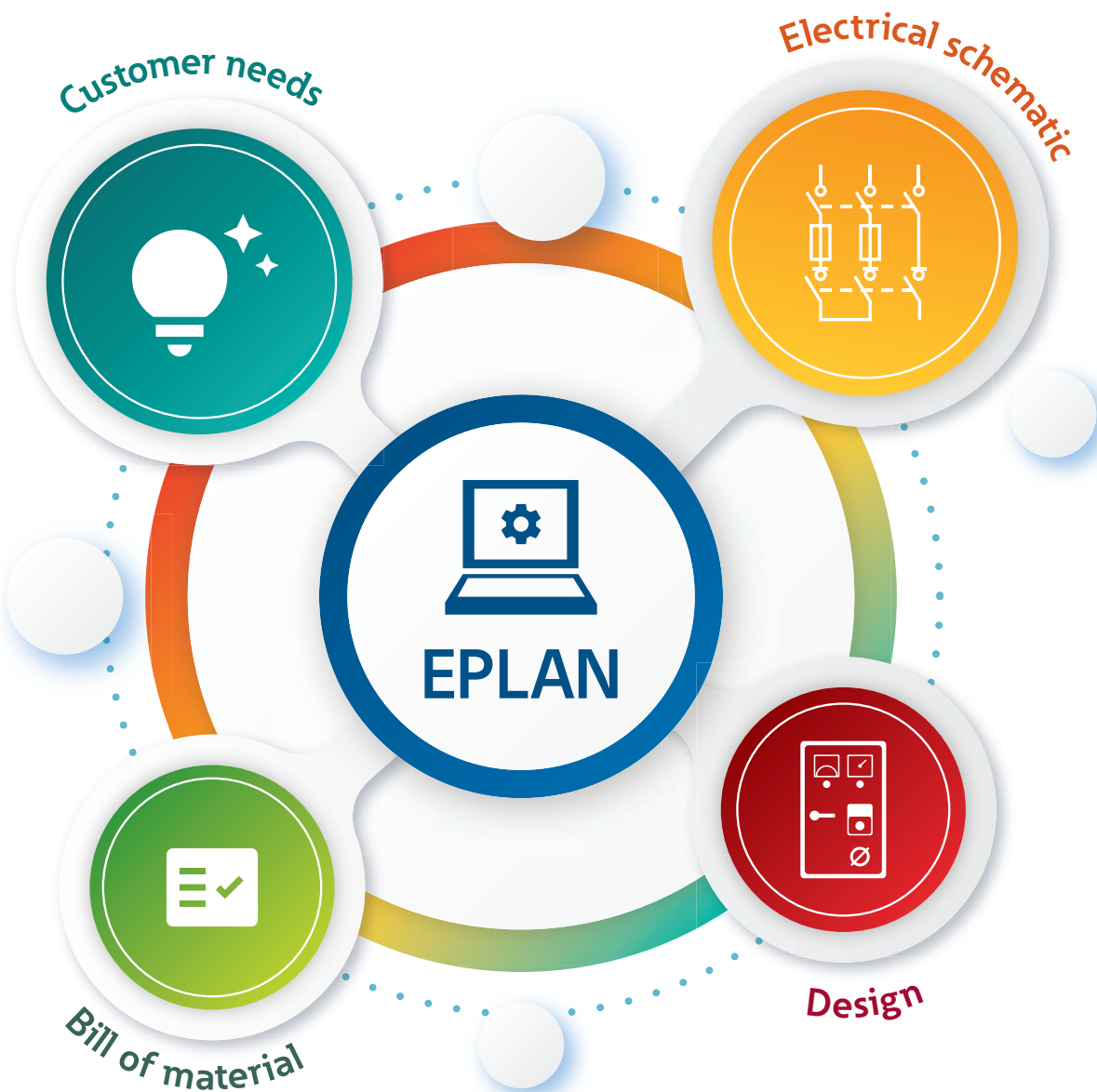



# Safe switching, isolating and control

The high-performance, robust and compact T Rotary Cam Switches and P Switch-disconnectors are used in machine building, industrial and engineering applications. They provide ultimate safe disconnection and endurance with positive mechanical contact breaking and excellent making & breaking capabilities. Their IP65 degree of protection enables use in harsh environments, and with essential global approvals the T & P range is a perfect switching, isolating and control solution.

P & T switches are available in an extensive range of complete pre-built switch/handle and enclosure combinations ex-stock to suit the specific requirements of our customers. This saves valuable time in the customer's assembly process as well as reducing packaging waste and order administration.

T rotary cam switches are suitable for a wide range of industrial and machine control applications: change-over and step switches, star-delta and reversing switches, etc. Several thousand switching types are available as standard, and customised circuits can also be produced to meet specific customers' needs, contact [buletechnical@eaton.com](mailto:buletechnical@eaton.com) for further information.



# Table of contents

<b>P Switch-disconnectors overview</b>	<b>6</b>
<b>T Rotary cam switches overview</b>	<b>10</b>
<b>Flush mounting switch-disconnectors</b>	<b>16 - 46</b>
Description	16
Range overview	17
On-Off switch-disconnectors	
Without auxiliary contacts	18
With auxiliary contacts	23
Main switch-disconnectors	
Without auxiliary contacts	24
With auxiliary contacts	26
Changeover switch-disconnectors	28
Coding switch-disconnectors	32
Manual/auto switch-disconnectors	33
Multi speed switch-disconnectors	34
Reversing switch-disconnectors	35
Selector switch-disconnectors	37
Star delta switch-disconnectors	38
Step switch-disconnectors	39
Step switch-disconnectors for heating	43
Universal control switch-disconnectors	44
Accessories	45
<b>Centre mounting switch-disconnectors</b>	<b>47 - 67</b>
Description	47
Range overview	48
On-Off switch-disconnectors	
Without auxiliary contacts	49
With auxiliary contacts	51
Changeover switch-disconnectors	52
Coding switch-disconnectors	55
Control switch-disconnectors	56
Group switch-disconnectors	57
Manual/auto switch-disconnectors	58
Multi speed switch-disconnectors	59
Reversing switch-disconnectors	60
Reversing star delta switch-disconnectors	61
Selector switch-disconnectors	62
Step switch-disconnectors	63
Step switch-disconnectors for heating	67
<b>Rear mounting switch-disconnectors</b>	<b>68 - 94</b>
Description	68
Range overview	69
On-Off switch-disconnectors	
Without auxiliary contacts	70
With auxiliary contacts	72
Main switch-disconnectors	
Without auxiliary contacts	73
With auxiliary contacts	75
Main switch-disconnectors with 400 mm metal extension shaft	
Without auxiliary contacts	77
With auxiliary contacts	79
Changeover switch-disconnectors	81
Manual/auto switch-disconnectors	83

<b>Rear mounting switch-disconnectors</b>	<b>68 - 94</b>
Multi speed switch-disconnectors	84
Reversing switch-disconnectors	85
Selector switch-disconnectors	86
Star delta switch-disconnectors	87
Step switch-disconnectors	88
Universal switch-disconnectors for heating	90
Accessories	91
<b>Service distribution board mounting switch-disconnectors</b>	<b>95 - 113</b>
Description	95
Range overview	96
On-Off switch-disconnectors	
Without auxiliary contacts	97
With auxiliary contacts	100
Changeover switch-disconnectors	101
Coding switch-disconnectors	103
Manual/auto switch-disconnectors	104
Multi speed switch-disconnectors	105
Reversing switch-disconnectors	106
Selector switch-disconnectors	107
Star delta switch-disconnectors	108
Step switch-disconnectors	109
Step switch-disconnectors for heating	111
Universal control switch-disconnectors	112
Accessories	113
<b>Enclosed switch-disconnectors</b>	<b>114 - 152</b>
Description	114
Range overview	115
On-Off switch-disconnectors	
Without auxiliary contacts	116
With auxiliary contacts	121
Main switch-disconnectors	
Without auxiliary contacts	123
With auxiliary contacts	129
Changeover switch-disconnectors	135
Coding switch-disconnectors	139
Manual/auto switch-disconnectors	140
Multi speed switch-disconnectors	141
Reversing switch-disconnectors	142
Safety switch-disconnectors	143
Selector switch-disconnectors	146
Star delta switch-disconnectors	147
Step switch-disconnectors	148
Step switch-disconnectors for heating	149
Universal control switch-disconnectors	150
Accessories	151
<b>Universal accessories</b>	<b>153</b>
<b>Non standard cam switches and switch-disconnectors</b>	<b>164</b>
<b>Standards</b>	<b>178</b>
<b>Characteristic curves</b>	<b>182</b>
<b>Technical data</b>	<b>183</b>
<b>Dimensions</b>	<b>194</b>
<b>Index</b>	<b>209</b>

# P Switch-disconnectors - Overview

## Range overview by switch-disconnectors type and mounting forms

	P1			P3		P5			
<b>Rated current (Amps)</b>	25	32	40	63	100	125	160	250	315
<b>Rated voltage (V a.c.)</b>	690	690	690	690	690	690	690	690	690
<b>Max motor rating AC-23A, 400/415 V, 50/60 Hz</b>	13 kW	15 kW	15 kW	37 kW	50 kW	45 kW	55 kW	90 kW	110 kW
<b>Switch-disconnectors type</b>									
Main switches maintenance/manual override switches	✓	✓	✓	✓	✓	✓	✓	✓	✓
On-Off switches	✓	✓	✓	✓	✓	✓	✓	✓	✓
Safety switches with warning labels	✓	✓		✓	✓				
<b>Switches with interlocks type</b>									
With cylinder lock SVA	✓	✓							
With padlocking feature SVC	✓	✓							
On-Off switch without emergency stop function	✓	✓							
<b>Mounting forms</b>									
'E' Flush mounting	✓	✓	✓	✓	✓	✓	✓	✓	✓
'EA/SVB' Flush mounting main switch	✓	✓	✓	✓	✓				
'EZ' Centre mounting	✓	✓	✓						
'Z' Rear mounting	✓	✓	✓	✓	✓				
'V/SVB' Rear mounting main switches	✓	✓	✓	✓	✓	✓	✓	✓	✓
'M4/SVB' Rear mounting main switches with extension shaft	✓	✓	✓	✓	✓				
'IVS' Service distribution board mounting	✓	✓	✓	✓	✓				
'I' Surface mounting switch-disconnector fitted in Ci-K Enclosure	✓	✓	✓	✓	✓				
'MBS' Surface mounting switch-disconnector fitted in Ci-K Enclosure, with pre-assembled EMC screen	✓	✓	✓	✓					
'SE' Surface mounting fitted in steel enclosures	✓	✓	✓	✓	✓				

## System overview

### P1 and P3 Switch-disconnectors

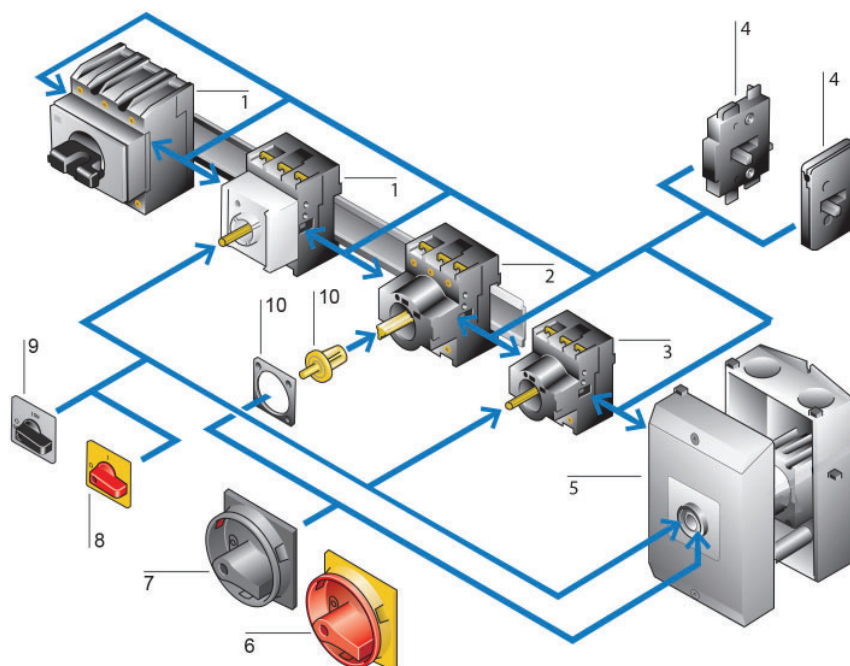

1. Service distribution board mounting
2. Rear mounting
3. Flush mounting
4. Neutral conductors, auxiliary contacts
5. Surface mounting
6. Main switch (kit) for use as emergency switching off device
7. Main switch (kit)
8. Thumb grip for use as emergency switching off device
9. Thumb grip
10. Coupling drive



# P Switch-disconnectors - Overview

## System overview

### P1 and P3 Switch-disconnectors with metal shaft

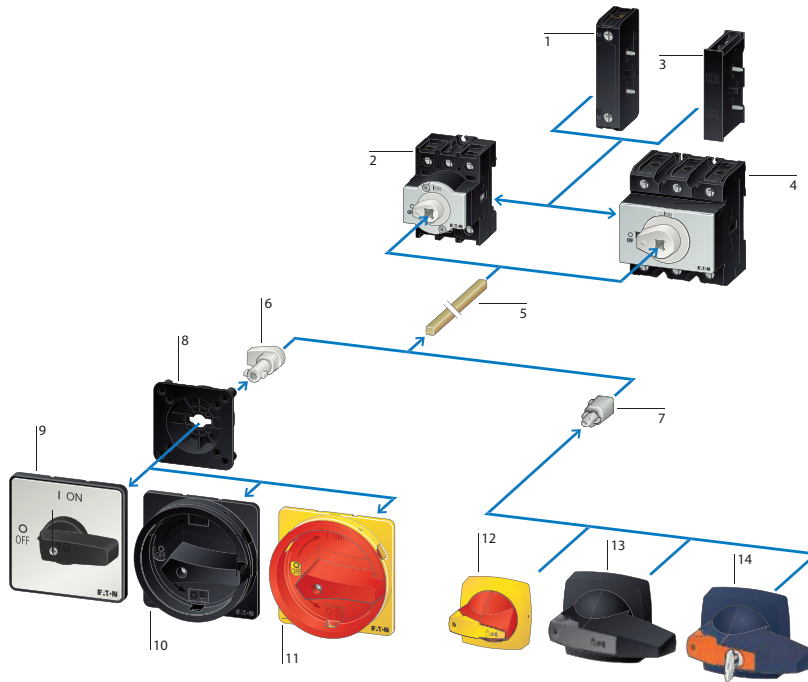

1. Neutral conductor
2. P1 rear mounting switch
3. Auxiliary contact
4. P3 rear mounting switch
5. Metal shaft
6. Shaft adaptor
7. Shaft adaptor
8. Centring Adaptor
9. Thumb grip
10. Main switch (kit) black
11. Main switch kit for use as emergency switching off device (red)
12. Thumb grip kit for use as emergency switching off device (red)
13. K-Line padlock handles
14. K-Line cylinder lock handles

### P5 Switch-disconnectors

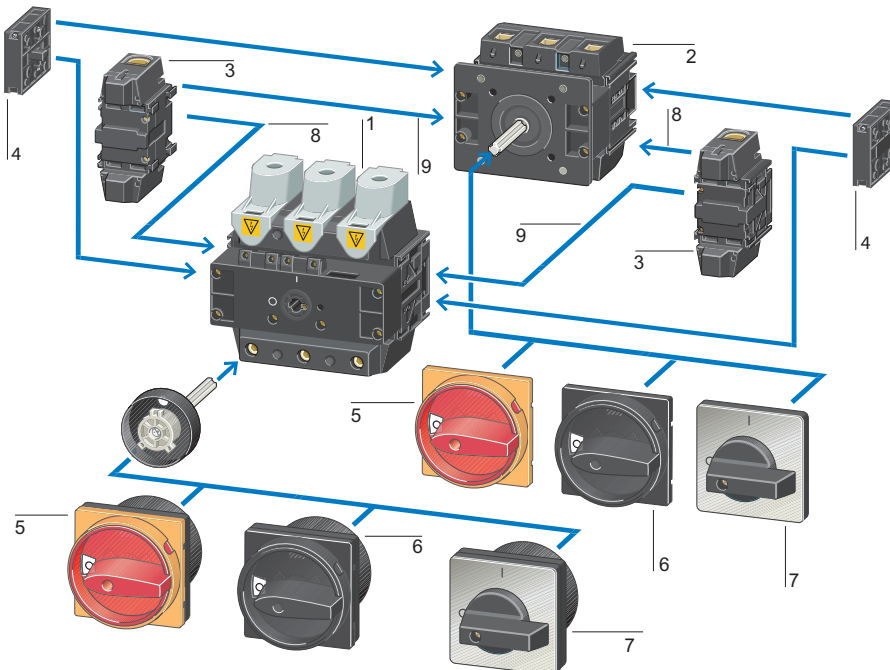

1. Rear mounting
2. Flush mounting
3. Neutral conductors
4. Auxiliary contacts
5. Main switch (kit) for use as emergency switching off device
6. Main switch (kit)
7. Thumb grip
8. Ground terminal
9. Neutral terminal

# P Switch-disconnectors - Overview

## P1 and P3 Key to part numbers

<b>P</b>	<b>Switch size</b>	-	<b>Rated uninterrupted current</b>	/	<b>Mounting form</b>	-	<b>Part number suffix</b>	/	<b>Accessories</b>
	P1 or P3	-		/		-		/	

## P1 and P3 add-on function due to modular system

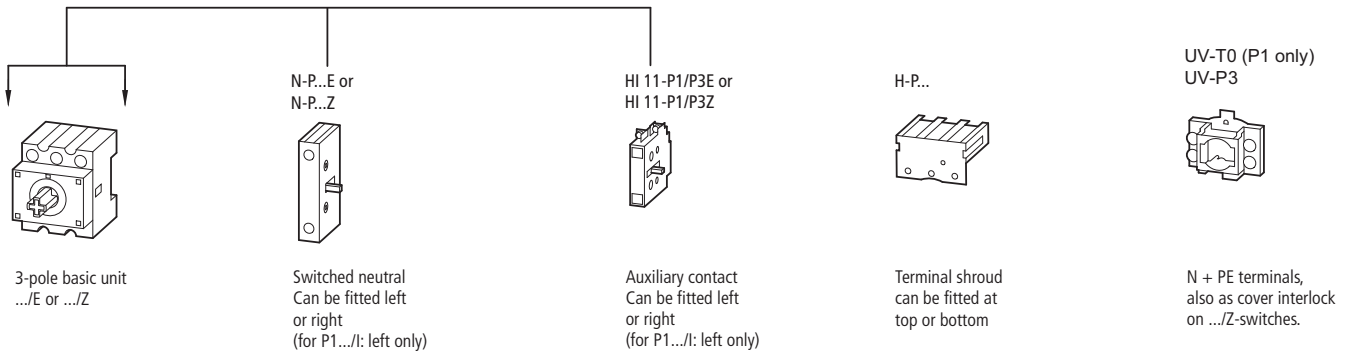

## Catalogue number system

### Flush mounting 'E' and 'EA'

<b>P</b>	-	<b>Rated current (Amps)</b>	/	<b>Mounting form, switch type, handle type</b>	/	<b>Accessories</b>
<b>P1</b>		25 (P1 only)		<b>EA/SVB</b> : Flush mounting, main switch with red/yellow handle <b>EA/SVB-SW</b> : Flush mounting, main switch with black handle <b>E</b> : Flush mounting with black thumb grip and front plate <b>E-RT</b> : Flush mounting with red thumb grip		
		32 (P1 only)				
		40 (P1 only)				
<b>P3</b>		63 (P3 only)				
		100 (P3 only)				
<b>P5</b>		125 (P5 only)				
		160 (P5 only)				
		250 (P5 only)				
		315 (P5 only)				

### Centre mounting 'EZ' P1 switch-disconnectors

<b>P</b>	-	<b>Rated current (Amps)</b>	/	<b>Switch type, mounting form, handle type</b>	/	<b>Nb of poles</b>
<b>P1</b>		25 (P1 only) 32 (P1 only) 40 (P1 only)		<b>EZ</b> : Centre mounting, ON-OFF switch with black thumb grip and front plate		<b>N</b> : 3-pole + Neutral

### Surface mounting 'I' P1 and P3 switch-disconnectors fitted in Ci-K Enclosures

<b>P</b>	-	<b>Rated current (Amps)</b>	/	<b>Mounting form</b>	<b>Ci-K Enclosure size (H x W mm)</b>	<b>H</b>	/	<b>Type of switch, handle</b>	/	<b>Accessories</b>
<b>P1</b>		25 (P1 only)		<b>I</b> : Surface mounting in Ci-K Enclosure	<b>1</b> (131 x 80 mm) <b>2</b> (181 x 100 mm) <b>3</b> (222 x 120 mm) <b>4</b> (240 x 160 mm) <b>5</b> (280 x 200 mm)	<b>H</b> : Hard knockouts		<b>SVB</b> : Main switch with red/yellow handle <b>SVB-SW</b> : Main switch with black handle <b>MBS/SVB</b> : Main switch with red/yellow handle and pre-assembled EMC screen <b>MBS/SVB-SW</b> : Main switch with black handle and pre-assembled EMC screen <b>SVA(S)</b> : Panic switch with SVA cylinder lock <b>SVC(S)</b> : Panic switch with SVC padlock <b>SVA(A)</b> : ON-OFF switch with SVA cylinder lock <b>S</b> : ON-OFF switch with key operation lock mechanism ST-0		
		32 (P1 only)								
		40 (P1 only)								
<b>P3</b>		63 (P3 only)								

# P Switch-disconnectors - Overview

## Catalogue number system

### Surface mounting 'SE' P1 and P3 switch-disconnectors fitted in steel enclosure

P	-	Rated current (Amps)	/	Steel enclosure type	/	Switch type, handle type	/	Accessories
P1		25 (P1 only)		SE1 (P1 only)		<b>SVB</b> : Main switch with red/yellow handle <b>SVB-SW</b> : Main switch with black handle  (Blank) Switch with ON-OFF function		
		32 (P1 only)		SE3 (P3 only)				
		40 (P1 only)						
P3		63 (P3 only)						
		100 (P3 only)						

### Service distribution board mounting 'IVS' P1, P3 and P5 switch-disconnectors

P	-	Rated current (Amps)	/	Mounting form, switch type, handle type
P1		25 (P1 only)		<b>IVS</b> : ON-OFF Service distribution board mounting switch with black thumb grip and front plate  <b>IVS-RT</b> : ON-OFF Service distribution board mounting switch with red thumb grip
		32 (P1 only)		
		40 (P1 only)		
P3		63 (P3 only)		
		100 (P3 only)		

### Rear mounting 'V/SVB', 'M4' and 'Z' P1, P3 and P5 switch-disconnectors

P	-	Rated current (Amps)	/	Mounting form, switch type, handle type	/	Accessories
P1		25 (P1 only)		<b>V/SVB</b> : Rear mounting, main switch with red/yellow handle  <b>V/SVB-SW</b> : Rear mounting, main switch with black handle		
		32 (P1 only)				
		40 (P1 only)				
P3		63 (P3 only)		<b>M4/SVB</b> : Rear mounting, main switch with 400 mm extension shaft with red/yellow handle  <b>M4/SVB-SW</b> : Rear mounting, main switch with 400 mm extension shaft with blank handle		
		100 (P3 only)				
P5		125 (P5 only)		<b>M4/K2-P..</b> : Main switch with 400 mm extension shaft with K Line K2 handle, padlockable  <b>Z</b> : ON-OFF switch with black thumb grip and front plate  <b>Z/SVA(A)</b> : ON-OFF switch with black thumb grip and front plate and SVA cylinder locks		
		160 (P5 only)				
		250 (P5 only)				
		315 (P5 only)				

For any Switch-disconnectors that currently holds a North American (NA) approval, a NA style variant can be made available to order, please contact your local sales representative for more information.

# T Rotary Cam switches - Overview

## Range overview by switch-disconnectors type and mounting forms

	TM	T0	T3	T5B	T5	T6	T8
<b>Rated current (Amps)</b>	≤10	20	32	63	100	160	315
<b>Rated voltage (V a.c.)</b>	500 V	690 V	690 V	690 V	690 V	690 V	690 V
<b>Max motor rating AC-23A 400/415 V 50/60 Hz</b>	3.0 kW	6.5 kW	13 kW	22 kW	30 kW	55 kW	132 kW
<b>Switch-disconnectors</b>							
Main switches maintenance/manual override switches		✓	✓	✓	✓	✓	✓
On-Off switches	✓	✓	✓	✓	✓		
Changeover switches		✓	✓	✓	✓	✓	✓
Reversing switch with 0 position		✓	✓	✓			
Star-delta switches		✓	✓	✓			
Reversing star-delta switches		✓	✓	✓			
Multi-speed switch		✓	✓	✓			
Reversing multi-speed switches		✓	✓	✓			
<b>Control switches</b>							
Step switches	✓	✓	✓				
Control circuit isolators	✓						
On-Off switches		✓	✓				
Changeover switches	✓	✓	✓				
Manual/Auto switches	✓	✓	✓				
On switches		✓	✓				
Universal control switches		✓	✓				
Coding switches	✓	✓	✓				
Series switches		✓	✓				
Instrument selector switches		✓	✓				
Mini Cam Group switches	✓						
Mini Cam ON-OFF switches	✓						
Mini Cam Reversing switches	✓						
<b>Switches with locking mechanism - Panic switch</b>							
With cylinder lock SVA		✓					
With padlocking feature SVC		✓					
On-Off switch without emergency stop function		✓					
<b>Mounting forms</b>							
'E' Flush mounting	✓	✓	✓	✓	✓	✓	✓
'EA/SVB' Flush mounting main switch		✓	✓	✓	✓		
'EZ' Centre mounting	✓	✓	✓				
'I' Enclosed switch-disconnector fitted in Ci-K Enclosure		✓	✓	✓	✓	✓	✓
'IVS' Service distribution board mounting	✓	✓	✓	✓			
'MBS' Enclosed switch-disconnector fitted in Ci-K Enclosure, with pre-assembled EMC screen		✓					
'SE' Enclosed switch-disconnectors fitted in steel enclosures		✓	✓				
'V/SVB' Rear mounting main switches		✓	✓	✓	✓	✓	✓
'Z' Rear mounting		✓	✓	✓	✓		



# T Rotary Cam switches - Overview

## System overview

### TM Switch-disconnectors

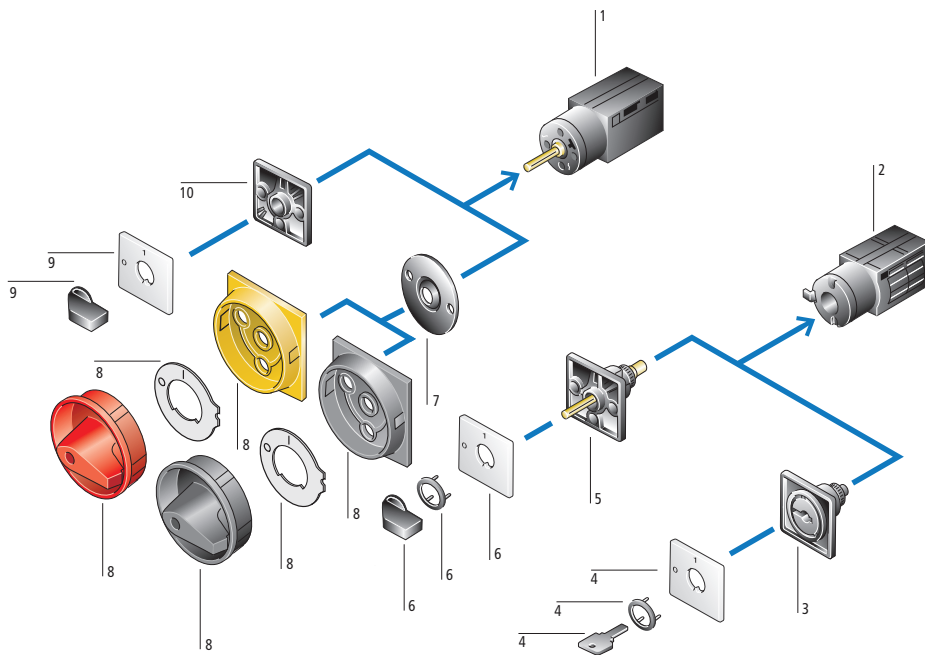

- 1. Flush mounting
- 2.Center mounting
- 3 and 4 . Key operation for center mounting
- 5 and 6. Standard switches for center mounting
- 7 and 8. Control circuit isolators
- 9 and 10. Standard switches for flush mounting

### TM - Control switches

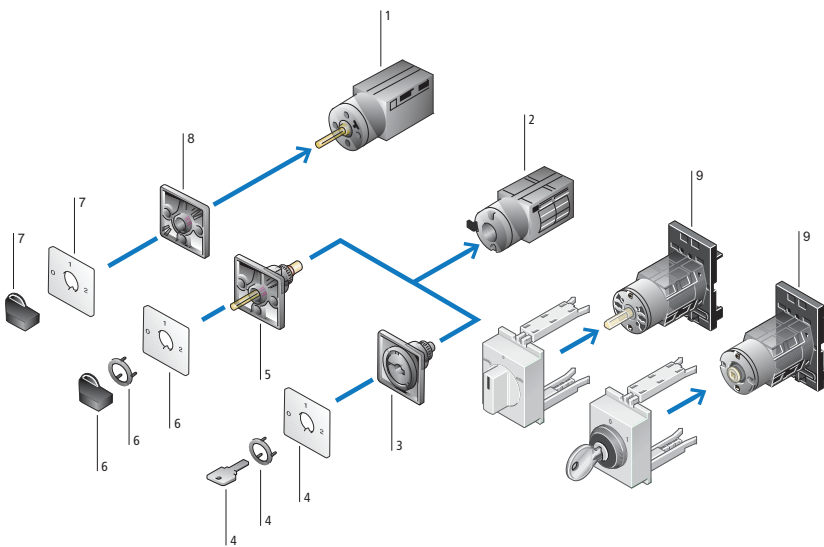

- 1. Flush mounting
- 2.Center mounting
- 3 and 4 . Key operation for center mounting
- 5 and 6. Standard switches for center mounting
- 7 and 8. Standard switches for flush mounting
- 9. Service distribution board mounting

# T Rotary Cam switches - Overview

## System overview

### T0, T3, T5B, T5 Switch-disconnectors

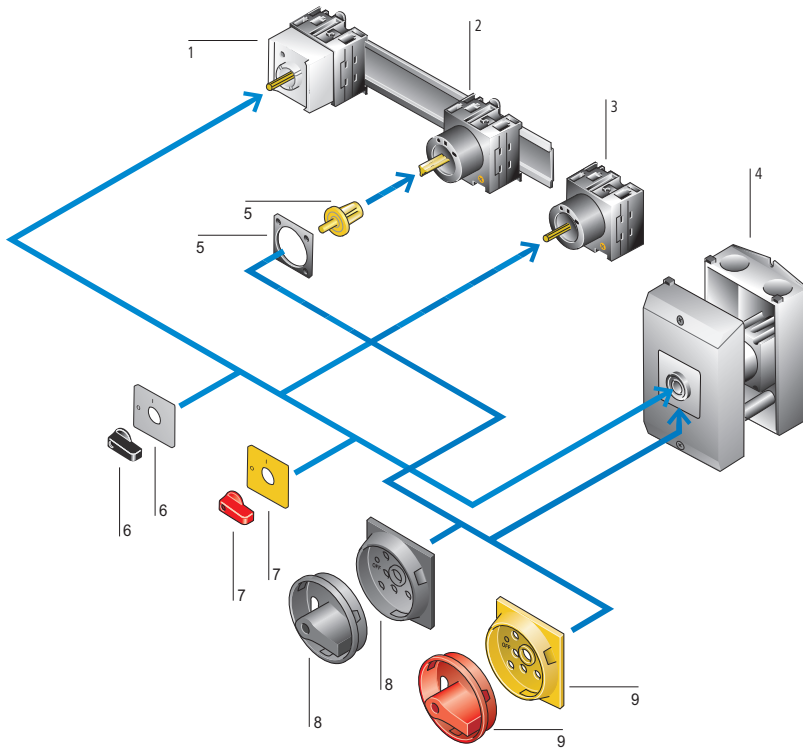

1. Service distribution board mounting
2. Rear mounting
3. Flush mounting
4. Surface mounting
5. Coupling drive
6. Thumb grip
7. Thumb grip for use as emergency switching off device (not for Control switch)
8. Main switch kit (not for Control switch)
9. Main switch kit not for use as emergency switch-off (not for Control switch)

## Circuit representation for all T versions

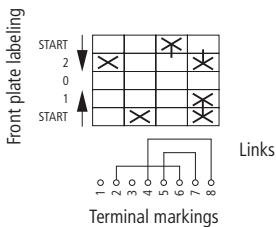

### Switch from 0 to 1

Contact 1 – 2 open,  
Contact 3 – 4 open,  
Contact 5 – 6 open,  
Contact 7 – 8 closed

### Switch from 1 to START with automatic return to 1

Contact 1 – 2 open,  
Contact 3 – 4 closed,  
Contact 5 – 6 open,  
Contact 7 – 8 remains closed

### Switch from 1 to 0

Contact 1 – 2 open,  
Contact 3 – 4 open,  
Contact 5 – 6 open,  
Contact 7 – 8 open

### Switch from 0 to 2

Contact 1 – 2 closed,  
Contact 3 – 4 open,  
Contact 5 – 6 open,  
Contact 7 – 8 closed

### Switch from 2 to START with automatic return to 2

Contact 1 – 2 open,  
Contact 3 – 4 open,  
Contact 5 – 6 closes with early make,  
Contact 7 – 8 opens with late break

### Switch from 2 to 0

Contact 1 – 2 open,  
Contact 3 – 4 open,  
Contact 5 – 6 open,  
Contact 7 – 8 open

# T Rotary Cam switches - Overview

## TM - Key to part numbers

The TM Mini cam switch is a particularly small switch for small space requirements. It is ideally suited for lower voltages and currents such as electronic controls. For greater safety the contacts are gold plated. The TM switches have consecutive terminal markings starting with 1.

TM	-	Number of contact chambers	-	Contact sequence number	-	Mounting form	+	Accessories
TM	-	= contact units	-		-		+	

## T0 and T3 Cam switches - Key to part numbers

Cam switches can be used for many switching and control applications. For example ON-OFF switches, main switches, main/control switches, instrument switches.

The switches consist of a hand actuator, the switch unit and the mounting accessories.

The contact chambers (contact unit = BE) contains 1 or 2 contacts.

T	Switch size	-	Number of contact chambers	-	Contact sequence number	/	Mounting form
T0 or T3		-	= contact units	-		/	

### Using the modular system to convert the mounting form

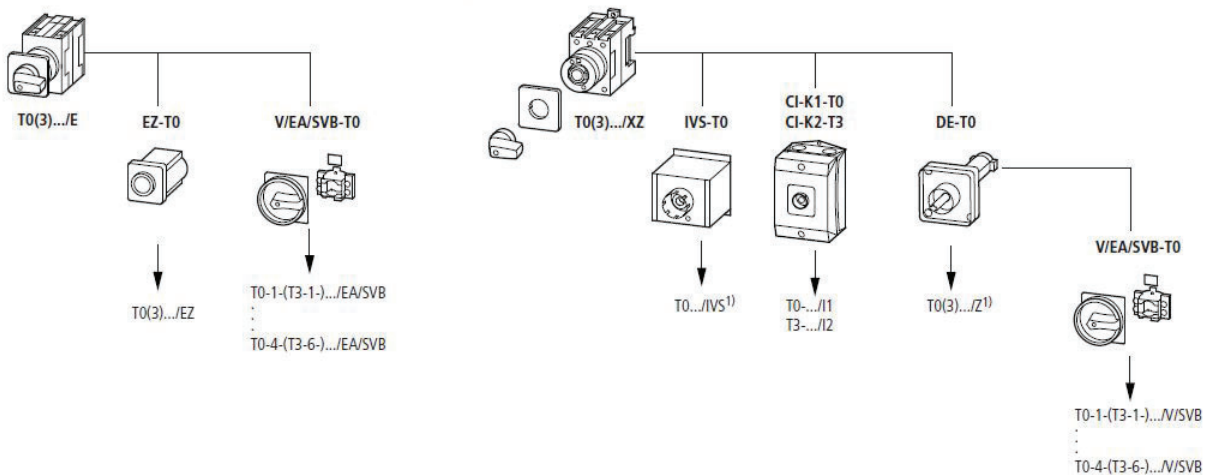

## T5(B) Cam switches - Key to part numbers

T	Switch size	-	Number of contact chambers	-	Contact sequence number	/	Mounting form
T5(B)		-	= contact units	-		/	

### Using the modular system to convert the mounting form T5(B)

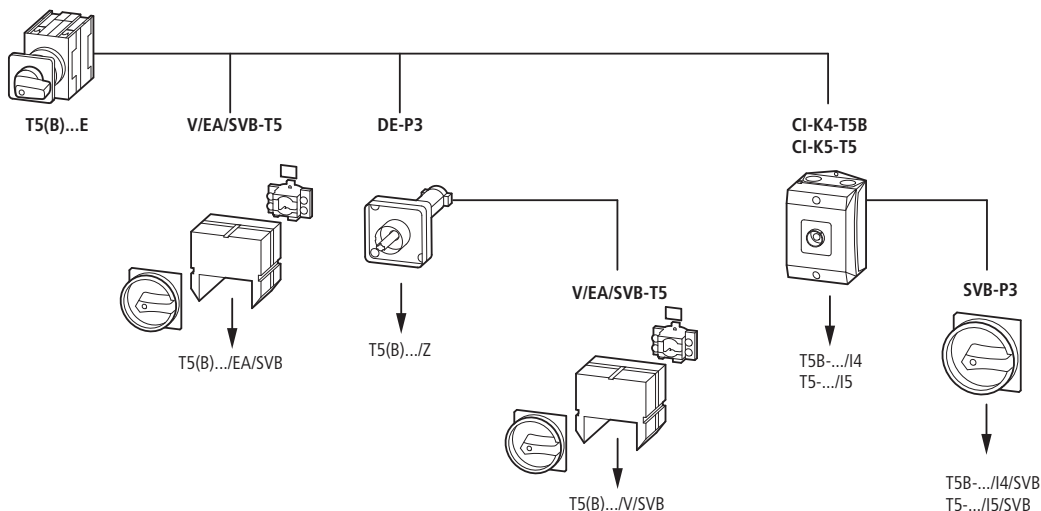

# T Rotary Cam switches - Overview

## Catalogue number system

### Flush mounting 'E' and 'EA'

T	Switch size	- Number of contact units (contact chambers)	- Contact sequence number	/	Mounting form, switch type, handle type	/	Accessories
T	<b>M</b> (10 A) <b>0</b> (20 A) <b>3</b> (32 A) <b>5B</b> (63 A) <b>5</b> (100 A) <b>6</b> (160 A) <b>8</b> (315 A)	TM: Maximum 8 chambers / 16 contacts T0/T3: maximum 11 chambers / 22 contacts T5/TB: maximum 10 chambers / 20 contacts			<b>EA/SVB</b> : Flush mounting, main switch with red/yellow handle <b>EA/SVB-SW</b> : Flush mounting, main switch with black handle <b>E</b> : Flush mounting with black thumb grip and front plate <b>E-RT</b> : Flush mounting, ON-OFF switch with red thumb grip		

### Centre mounting 'EZ'

T	Switch size	- Number of contact units (contact chambers)	- Contact sequence number	/	Mounting form, switch type, handle type	/	Accessories
T	<b>M</b> (10 A) <b>0</b> (20 A) <b>3</b> (32 A)	TM: Maximum 8 chambers / 16 contacts T0/T3: maximum 11 chambers / 22 contacts			<b>EZ</b> : Centre mounting with black thumb grip and front plate		

### Rear mounting 'V/SVB', 'M4' and 'Z' T switch-disconnectors

T	Switch size	- Number of contact units (contact chambers)	/	Number of contact units (contact chambers)	/	Accessories
T	<b>0</b> (20 A) <b>3</b> (32 A) <b>5B</b> (63 A) <b>5</b> (100 A) <b>6</b> (160 A) <b>8</b> (315 A)			<b>V/SVB</b> : Rear mounting, main switch with red/yellow handle <b>V/SVB-SW</b> : Rear mounting, main switch with black handle <b>Z</b> : ON-OFF switch with black thumb grip and front plate <b>Z/SVA(A)</b> : ON-OFF switch with black thumb grip and front plate and SVA cylinder locks		

### Service distribution board mounting 'IVS' T0 switch-disconnectors

T	Switch size	/	Number of contact units (contact chambers)	/	Mounting form, switch type, handle type	/	Accessories
T	<b>0</b> (20 A)		T0/T3: maximum 11 chambers / 22 contacts		<b>IVS</b> : ON-OFF Service distribution board mounting switch with black thumb grip and front plate <b>IVS-RT</b> : ON-OFF Service distribution board mounting switch with red thumb grip		



# T Rotary Cam switches - Overview

## Catalogue number system

### Enclosed 'I' switch-disconnectors fitted in Ci-K Enclosures

T	Switch size	-	Number of contact units (contact chambers)	/	Mounting form	Ci-K Enclosure size (H x W mm)	/	Type of switch, handle	/	Accessories
T	0 (20 A) 3 (32 A) 5B (63 A) 5 (100 A) 6 (160 A) 8 (315 A)		T0/T3: max 11 chambers / 22 contacts  T5/TB: max 10 chambers / 20 contacts		I : Surface mounting in Ci-K Enclosure	1 (131 x 80 mm) 2 (181 x 100 mm) 3 (222 x 120 mm) 4 (240 x 160 mm) 5 (280 x 200 mm)		<b>SVB:</b> Main switch with red/yellow handle  <b>SVB-SW:</b> Main switch with black handle  <b>MBS/SVB:</b> Main switch with red/yellow handle and pre-assembled EMC screen  <b>MBS/SVB-SW:</b> Main switch with black handle and pre-assembled EMC screen  <b>SVA(S):</b> Panic switch with SVA cylinder lock  <b>SVA(A):</b> ON-OFF switch with SVA cylinder lock  <b>SVC(S):</b> Panic switch with SVC padlock  <b>SI:</b> Safety switch		

### Enclosed 'SE' T0 and T3 switch-disconnectors fitted in steel enclosure

T	Switch size	-	Number of contact units (contact chambers)	-	Steel enclosure size	/	Type of switch, handle
T	0 (20 A) 3 (32 A)		T0/T3: max11 chambers / 22 contacts		SE1  SE3		<b>SVB:</b> Main switch with red/yellow handle  <b>SVB-SW:</b> Main switch with black handle  (Blank) Switch with ON-OFF function

For any Switch-disconnectors that currently holds a North American (NA) approval, a NA style variant can be made available to order, please contact your local sales representative for more information.

# Flush mounting switch-disconnectors

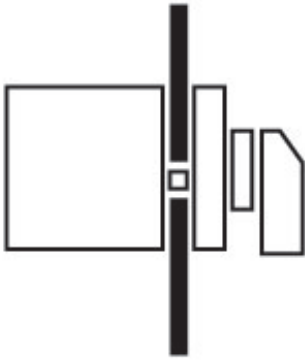

## Description

Flush mounting switch-disconnectors can be easily installed, using two-hole screw mounting, directly onto doors, panels, lids, enclosures in machinery, switchboard and switchgear.

## Standards/Approvals

See details page 178

## Technical data

- Voltage: 690 V a.c.
- Current: 10 A to 315 A
- Front IP65

## Options

- With or without emergency switching off/emergency stop function
- With and without auxiliary contacts
- With red rotary handle and yellow locking collar and black rotary handle and locking collar
- 1-pole to 8-pole



P3 Flush mounting







T0 Flush mounting

## Flush mounting - Range overview

Rated current	10 A	20 A	25 A	32 A	40 A	63 A	100 A	125 A	160 A	250 A	275 A	315 A		
<b>On-Off switch-disconnectors</b>	TM	T0	P1	P1	T3	P1	P3	T5B	P3	T5	P5	P5	P5	P5
Without auxiliary contacts	✓	✓	✓	✓	✓	✓	✓	✓	✓	✓	✓	✓	✓	✓
With auxiliary contacts		✓			✓			✓		✓				
<b>Main switch-disconnectors</b>		T0	P1	P1	T3	P1	P3	T5B	P3	T5	P5	P5	P5	P5
Without auxiliary contacts		✓	✓	✓	✓	✓	✓	✓	✓	✓	✓	✓	✓	✓
With auxiliary contacts		✓	✓	✓	✓	✓	✓	✓	✓	✓	✓	✓	✓	✓
<b>Changeover switch-disconnectors</b>	TM	T0			T3			T5B		T5			T6	T8
Without auxiliary contacts	✓	✓			✓			✓		✓			✓	✓
<b>Coding switch-disconnectors</b>	TM	T0												
Without auxiliary contacts	✓	✓												
<b>Manual/auto switch-disconnectors</b>	TM	T0												
Without auxiliary contacts	✓	✓												
<b>Multi speed switch-disconnectors</b>		T0			T3			T5B						
Without auxiliary contacts		✓			✓			✓						
<b>Reversing switch-disconnectors</b>	TM	T0			T3			T5B						
Without auxiliary contacts	✓	✓			✓			✓						
<b>Selector switch-disconnectors</b>		T0												
Without auxiliary contacts		✓												
<b>Star-delta switch-disconnectors</b>		T0			T3			T5B						
Without auxiliary contacts		✓			✓			✓						
<b>Step switch-disconnectors</b>	TM	T0												
Without auxiliary contacts	✓	✓												
<b>Step switch-disconnectors for heating</b>		T0												
Without auxiliary contacts		✓												
<b>Universal switch-disconnectors</b>		T0												
Without auxiliary contacts		✓												

# Flush mounting - On-Off switch-disconnectors without auxiliary contacts

## Without emergency switch off/emergency stop function

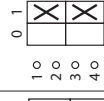
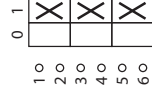
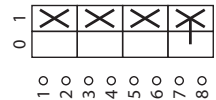
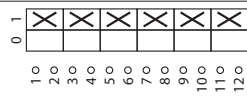
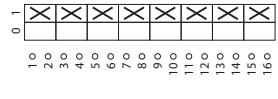
Front plate	Contact sequence	Number of poles N/O	Rated current	Part number	Article number	Pack qty	Suitable for export to North America (US and Canada)	Padlockable handle		
<b>On-Off switches 90°</b>										
 F 056		1	10 A	TM-1-8290/E	070131	1	✓	X		
		2	10 A	TM-1-8291/E	072504	1	✓	X		
		3	10 A	TM-2-8292/E	074877	1	✓	X		
		3+N	10 A	TM-2-8293/E	077250	1	✓	X		
		6	10 A	TM-3-8256/E	079623	1	✓	X		
<b>Without auxiliary contacts</b>										
 FS 908		1	20 A	T0-1-8200/E	067352	1	✓	X		
			32 A	T3-1-8200/E	064208	1	✓	X		
			63 A	T5B-1-8200/E	094281	1	✓	X		
		2	20 A	T0-1-102/E	088709	1	✓	X		
			32 A	T3-1-102/E	076073	1	✓	X		
			63 A	T5B-1-102/E	094471	1	✓	X		
				3	20 A	T0-2-1/E	024639	1	✓	X
					25 A	P1-25/E	038724	1	✓	X
					32 A	P1-32/E	079065	1	✓	X
	40 A	P1-40/E			199889	1	X	X		
	63 A	P3-63/E			026861	1	✓	X		
	100 A	P3-100/E			067201	1	✓	X		
	125 A	P5-125/E			280897	1	✓	X		
	160 A	P5-160/E			280921	1	✓	X		
	250 A	P5-250/E			280935	1	✓	X		
		3 + N	20 A	T0-2-8900/E	207398	1	✓	X		
			25 A	P1-25/E/N	076845	1	✓	X		
			32 A	P1-32/E/N	093456	1	✓	X		
			40 A	P1-40/E/N	199891	1	X	X		
			63 A	P3-63/E/N	019894	1	✓	X		
			100 A	P3-100/E/N	031759	1	✓	X		
		6	20 A	T0-3-8342/E	043624	1	✓	X		
			32 A	T3-3-8342/E	045225	1	✓	X		
			63 A	T5B-3-8342/E	092310	1	✓	X		
			8	20 A	T0-4-8344/E	014000	1	✓	X	
				32 A	T3-4-8344/E	020593	1	✓	X	
				63 A	T5B-3-8344/E	092064	1	✓	X	









067352

Photo is representative

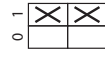
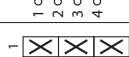

# Flush mounting - On-Off switch-disconnectors without auxiliary contacts

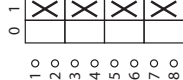
## Without emergency switch off/emergency stop function

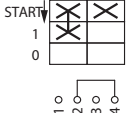
Front plate	Contact sequence	Number of poles N/O	Rated current	Part number	Article number	Pack qty	Suitable for export to North America (US and Canada)	Padlockable handle
<b>On-Off switches 30°</b>								
 FS 415		1	20 A	T0-1-15401/E	038854	1	✓	X
		2	20 A	T0-1-15402/E	053092	1	✓	X
		3	20 A	T0-2-15403/E	067330	1	✓	X
		4	20 A	T0-2-15404/E	081568	1	✓	X
								
<b>TM Switch-disconnector 90°/30° with Automatic (spring) return to 1</b>								
 F 119		1	10 A	TM-1-8178/E	098608	1	✓	X



053092









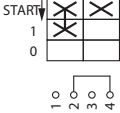

098608

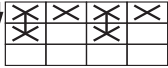
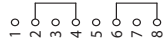
Photos are representative

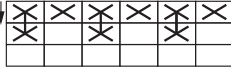
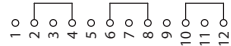

# Flush mounting - On-Off switch-disconnectors without auxiliary contacts

## Without emergency switch off/emergency stop function

Front plate	Contact sequence	Number of poles N/O	Rated current	Part number	Article number	Pack qty	Suitable for export to North America (US and Canada)	Padlockable handle
With Automatic (spring) return in START position								
		1	20 A	T0-1-15511/E	019875	1	✓	X
								
		2	20 A	T0-2-15512/E	034113	1	✓	X
								
								
		3	20 A	T0-3-15513/E	048351	1	✓	X
								
								
		2	20 A	T0-2-8177/E	015130	1	✓	X
FS 140660								

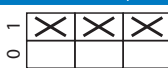

## Without emergency switch off/emergency stop function

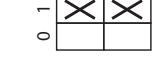
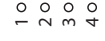
Front plate	Contact sequence	Pole N/O	Rated current	Part number	Article number	Pack qty	Suitable for export to North America (US and Canada)	Padlockable handle
With locking mechanism - Key can only be withdrawn in position 0 (Pos A)								
		3	20 A	T0-2-1/E/SVA(A)	050976	1	✓	✓
FS 908		3	25 A	P1-25/E/SVA(A)	050965	1	✓	✓
		3	32 A	P1-32/E/SVA(A)	050970	1	✓	✓
With locking mechanism Key operation lock mechanism ST-0 Key can only be withdrawn in position 0 (Pos A)								
		2	20 A	T0-1-102/EZ/S	014933	1	✓	X
FS 908								



050976



014933

Photos are representative

# Flush mounting - On-Off switch-disconnectors without auxiliary contacts

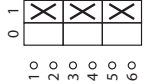

## Without emergency switch off/emergency stop function

Front plate	Contact sequence	Pole N/O	Rated current	Part number	Article number	Pack qty	Suitable for export to North America (US and Canada)	Padlockable handle
Panic switch-disconnector fitted with a SVA Cylinder lock Supplied with two keys If the key is withdrawn in position 1 the switch can be switched off but not on again without the key								
		3	20 A	T0-2-1/E/SVA(S)	050977	1	✓	✓
FS 908		3	25 A	P1-25/E/SA(S)	050966	1	✓	✓
		3	32 A	P1-32/E/SA(S)	044977	1	✓	✓



050966

## Without emergency switch off/emergency stop function

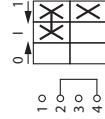
Front plate	Contact sequence	Number of poles N/O	Rated current	Number of poles	Part number	Article number	Pack qty	Suitable for export to North America (US and Canada)	Padlockable handle
Automatic (spring) return from position 1									
		1	20 A	1	T0-1-15321/E	086317	1	✓	X
FS 4721		2	20 A	2	T0-1-15322/E	010382	1	✓	X
		3	20 A	3	T0-2-15323/E	024620	1	✓	X
Automatic (spring) return in position 0 and 1									
		1	20 A		T0-1-15366/E	081572	1	✓	X
FS 456									









024620

Photos are representative

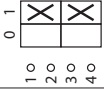
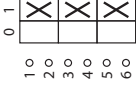
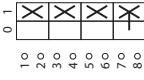
# Flush mounting - On-Off switch-disconnectors without auxiliary contacts

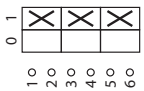
## With emergency switch off/emergency stop function

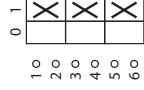
Front plate	Contact sequence	Number of poles N/O	Rated current	Part number	Article number	Pack qty	Suitable for export to North America (US and Canada)	Padlockable handle
 FS 908		1	20 A	T0-1-8200/E-RT	009474	1	✓	X
		32 A	T3-1-8200/E-RT	017025	1	✓	X	
		63 A	T5B-1-8200/E-RT	094280	1	✓	X	
		100 A	T5-1-8200/E-RT	097225	1	X	X	
		2	20 A	T0-1-102/E-RT	009046	1	✓	X
		32 A	T3-1-102/E-RT	016318	1	✓	X	
		63 A	T5B-1-102/E-RT	094470	1	✓	X	
		3	20 A	T0-2-1/E-RT	011082	1	✓	X
		25 A	P1-25/E-RT	002388	1	✓	X	
		32 A	P1-32/E-RT	003197	1	✓	X	
		40 A	P1-40/E-RT	199902	1	X	X	
		63 A	P3-63/E-RT	005743	1	✓	X	
		3 + N	20 A	T0-2-8900/E-RT	207399	1	✓	X
		100 A	P3-100/E-RT	007189	1	✓	X	
	<b>Panic switch-disconnector fitted with a SVA Cylinder lock</b> Supplied with two keys							
 FS 908 GE		3	20 A	T0-2-1/E/SVA(S)-RT	228291	1	✓	✓
		3	25 A	P1-25/E/SVA(S)-RT	050967	1	✓	✓
		3	32 A	P1-32/E/SVA(S)-RT	050971	1	✓	✓
<b>Panic switch-disconnectors fitted with SVC Padlocking feature</b> Supplied with two keys If the locking device is padlocked in position 1 the switch can be switched off but not on again without removing the padlock. Lockable with max 3 padlocks								
 FS 908 GE		3	20 A	T0-2-1/E/SVC(S)-RT	044973	1	✓	✓
		3	25 A	P1-25/E/SVC(S)-RT	044974	1	✓	✓
		3	32 A	P1-32/E/SVC(S)-RT	044975	1	✓	✓



207399



050967



044975

Photos are representative

# Flush mounting - On-Off switch-disconnectors with auxiliary contacts

## Without emergency switch off/emergency stop function

Front plate	Contact sequence	Number of poles			Auxiliary contacts			Rated current	Part number	Article number	Pack qty	Suitable for export to North America (US and Canada)	Padlockable handle
		N/O	N/O	N/C	N/O	N/O	N/C						
Without emergency switch off/emergency stop function													
FS 908		3	1	0	20 A	T0-2-15679/E	029387	1	✓	X			
		3	2	1	20 A	T0-2-15683/E	016619	1	✓	X			
					32 A	T3-2-15683/E	014377	1	✓	X			
		3 + N	1	1	20 A	T0-2-8901/E	231938	1	✓	X			
					32 A	T3-2-8901/E	213949	1	✓	X			
		6	1	1	20 A	T0-4-15682/E	010405	1	✓	X			
					32 A	T3-4-15682/E	023869	1	✓	X			
					63 A	T5B-4-15682/E	207424	1	✓	X			
					100 A	T5-4-15682/E	207412	1	✓	X			





207412

Photo is representative

# Flush mounting - Main switch-disconnectors without auxiliary contacts

## Without emergency switch off/emergency stop function

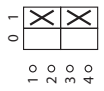
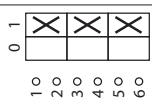
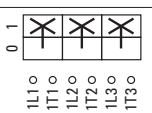
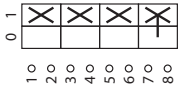
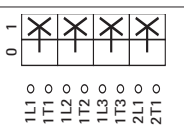
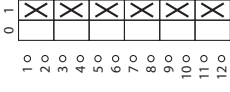
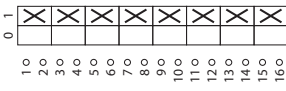
Front plate	Contact sequence	Number of poles	Rated current	Part number	Article number	Pack qty	Suitable for export to North America (US) and Canada	Padlockable handle
 FS 908		1	20 A	T0-1-8200/EA/SVB-SW	055483	1	✓	✓
			32 A	T3-1-8200/EA/SVB-SW	068949	1	✓	✓
			63 A	T5B-1-8200/EA/SVB-SW	094278	1	✓	✓
		2	20 A	T0-1-102/EA/SVB-SW	093451	1	✓	✓
			32 A	T3-1-102/EA/SVB-SW	016747	1	✓	✓
			63 A	T5B-1-102/EA/SVB-SW	094468	1	✓	✓
			100 A	T5-1-102/EA/SVB-SW	098807	1	X	✓
		3	20 A	T0-2-1/EA/SVB-SW	041246	1	✓	✓
			25 A	P1-25/EA/SVB-SW	048365	1	✓	✓
			30 A	P3-30/EA/SVB-SW-MCS	237893	1	✓	✓
			32 A	P1-32/EA/SVB-SW	053111	1	✓	✓
			40 A	P1-40/EA/SVB-SW	199898	1	X	✓
			63 A	P3-63/EA/SVB-SW	057857	1	✓	✓
			100 A	P3-100/EA/SVB-SW	062603	1	✓	✓
		3	125 A	P5-125/EA/SVB-SW	280911	1	✓	✓
			160 A	P5-160/EA/SVB-SW	280925	1	✓	✓
250 A			P5-250/EA/SVB-SW	280939	1	✓	✓	
315 A			P5-315/EA/SVB-SW	280953	1	✓	✓	
			3 + N	20 A	T0-2-8900/EA/SVB-SW	207401	1	✓
	25 A	P1-25/EA/SVB-SW/N		083960	1	✓	✓	
	32 A	P1-32/EA/SVB-SW/N		093452	1	✓	✓	
	40 A	P1-40/EA/SVB-SW/N		199900	1	X	✓	
	63 A	P3-63/EA/SVB-SW/N		012771	1	✓	✓	
	100 A	P3-100/EA/SVB-SW/N		022263	1	✓	✓	
		3 + N		125 A	P5-125/EA/SVB-SW/N	280913	1	✓
160 A			P5-160/EA/SVB-SW/N	280927	1	✓	✓	
250 A			P5-250/EA/SVB-SW/N	280941	1	✓	✓	
315 A			P5-315/EA/SVB-SW/N	280955	1	✓	✓	
	6	20 A	T0-3-8342/EA/SVB-SW	031755	1	✓	✓	
		32 A	T3-3-8342/EA/SVB-SW	073699	1	✓	✓	
		63 A	T5B-3-8342/EA/SVB-SW	092307	1	✓	✓	
		100 A	T5-3-8342/EA/SVB-SW	096382	1	X	✓	
	8	20 A	T0-4-8344/EA/SVB-SW	008268	1	✓	✓	
		32 A	T3-4-8344/EA/SVB-SW	008965	1	✓	✓	
		63 A	T5B-4-8344/EA/SVB-SW	092061	1	✓	✓	
		100 A	T5-4-8344/EA/SVB-SW	095960	1	X	✓	





053111

Photo is representative

# Flush mounting - Main switch-disconnectors without auxiliary contacts

## With emergency switch off/emergency stop function

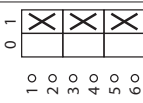
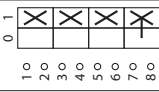
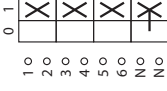
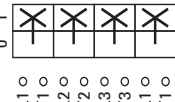
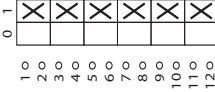
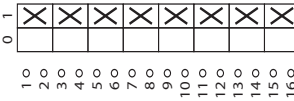
Front plate	Contact sequence	Number of poles N/O	Rated current	Part number	Article number	Suitable for export to North America (US) and Canada	Padlockable handle
 FS 908	 1 0 1 1 0 2 0	1	20 A	T0-1-8200/EA/SVB	053110	✓	✓
			32 A	T3-1-8200/EA/SVB	066576	✓	✓
			63 A	T5B-1-8200/EA/SVB	094279	✓	✓
	 1 0 1 0 2 0 3 0 4 0	2	20 A	T0-1-102/EA/SVB	091078	✓	✓
			32 A	T3-1-102/EA/SVB	014374	✓	✓
			63 A	T5B-1-102/EA/SVB	094469	✓	✓
			100 A	T5-1-102/EA/SVB	098808	X	✓
	 1 0 1 0 2 0 3 0 4 0 5 0 6 0	3	20 A	T0-2-1/EA/SVB	038873	✓	✓
			25 A	P1-25/EA/SVB	041097	✓	✓
			30 A	P3-30/EA/SVB-MCS	237892	✓	✓
			32 A	P1-32/EA/SVB	081438	✓	✓
			40 A	P1-40/EA/SVB	199894	X	✓
63 A			P3-63/EA/SVB	031607	✓	✓	
100 A			P3-100/EA/SVB	074320	✓	✓	
125 A			P5-125/EA/SVB	280898	✓	✓	
160 A			P5-160/EA/SVB	280922	✓	✓	
250 A			P5-250/EA/SVB	280936	✓	✓	
 1 0 1 0 2 0 3 0 4 0 5 0 6 0 7 0 8 0	3 + N	20 A	T0-2-8900/EA/SVB	207400	✓	✓	
		25 A	P1-25/EA/SVB/N	081587	✓	✓	
 1 0 1 0 2 0 3 0 4 0 5 0 6 0 N 0 N 0	3 + N	32 A	P1-32/EA/SVB/N	091079	✓	✓	
		40 A	P1-40/EA/SVB/N	199896	X	✓	
		63 A	P3-63/EA/SVB/N	010398	✓	✓	
		100 A	P3-100/EA/SVB/N	019890	✓	✓	
 1 0 1 0 1 1 0 1 1 0 1 2 0 1 3 0 1 3 0 2 1 0 2 1 0	3 + N	125 A	P5-125/EA/SVB/N	280910	✓	✓	
		160 A	P5-160/EA/SVB/N	280924	✓	✓	
		250 A	P5-250/EA/SVB/N	280938	✓	✓	
		315 A	P5-315/EA/SVB/N	280952	✓	✓	
 1 0 1 0 1 0 2 0 3 0 4 0 5 0 6 0 7 0 8 0 9 0 10 0 11 0 12 0	6	20 A	T0-3-8342/EA/SVB	029382	✓	✓	
		32 A	T3-3-8342/EA/SVB	071326	✓	✓	
		63 A	T5B-3-8342/EA/SVB	092308	✓	✓	
		100 A	T5-3-8342/EA/SVB	096383	X	✓	
 1 0 1 0 1 0 2 0 3 0 4 0 5 0 6 0 7 0 8 0 9 0 10 0 11 0 12 0 13 0 14 0 15 0 16 0	8	20 A	T0-4-8344/EA/SVB	008267	✓	✓	
		32 A	T3-4-8344/EA/SVB	008964	✓	✓	
		63 A	T5B-4-8344/EA/SVB	092062	✓	✓	
		100 A	T5-4-8344/EA/SVB	095961	X	✓	



041097

Photo is representative



# Flush mounting - Main switch-disconnectors with auxiliary contacts

## Without emergency switch off/emergency stop function

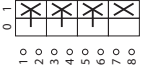
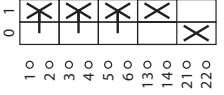
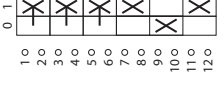
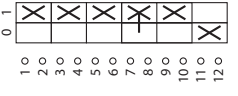
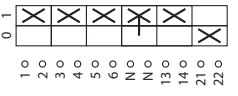
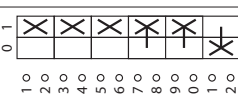
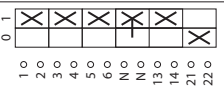
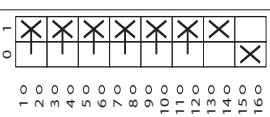
Front plate	Contact sequence	Number of poles			Auxiliary contacts			Rated current	Part number	Article number	Pack qty	Suitable for export to North America (US) and Canada	Padlockable handle
		N/O	N/O	N/C	N/O	N/O	N/C						
 FS 908	 1 0 2 0 3 0 4 0 5 0 6 0 7 0 8 0	3	1	0	20 A	T0-2-15679/EA/SVB-SW	083961	1	✓	✓			
	 1 0 2 0 3 0 4 0 5 0 6 0 13 0 14 0 21 0 22 0	3	1	1	25 A	P1-25/EA/SVB-SW/HI11	070194	1	✓	✓			
	32 A				P1-32/EA/SVB-SW/HI11	012772	1	✓	✓				
	40 A				P1-40/EA/SVB-SW/HI11	199899	1	X	✓				
	63 A				P3-63/EA/SVB-SW/HI11	022264	1	✓	✓				
	 1L1 0 1T1 0 1L2 0 1T2 0 1L3 0 1T3 0 7 0 8 0	3	1	0	125 A	P5-125/EA/SVB-SW/HI10	280912	1	✓	✓			
	160 A				P5-160/EA/SVB-SW/HI10	280926	1	✓	✓				
	250 A				P5-250/EA/SVB-SW/HI10	280940	1	✓	✓				
	315 A				P5-315/EA/SVB-SW/HI10	280954	1	✓	✓				
	 1 0 2 0 3 0 4 0 5 0 6 0 7 0 8 0 9 0 10 0 11 0 12 0	3	2	1	20 A	T0-3-15683/EA/SVB-SW	015600	1	✓	✓			
32 A	T3-3-15683/EA/SVB-SW				042851	1	✓	✓					
 1 0 2 0 3 0 4 0 5 0 6 0 7 0 8 0 9 0 10 0 11 0 12 0	3 + N	1	1	20 A	T0-3-15680/EA/SVB-SW	041248	1	✓	✓				
32 A				P1-25/EA/SVB-SW/N/HI11	050740	1	✓	✓					
32 A				T3-3-15680/EA/SVB-SW	231946	1	✓	✓					
 1 0 2 0 3 0 4 0 5 0 6 0 N 0 13 0 14 0 21 0 22 0	3 + N	1	1	32 A	P1-32/EA/SVB-SW/N/HI11	060232	1	✓	✓				
40 A				P1-40/EA/SVB-SW/N/HI11	199901	1	X	✓					
 1 0 2 0 3 0 4 0 5 0 6 0 7 0 8 0 9 0 10 0 11 0 12 0	3 + N	1	1	20 A	T0-3-8901/EA/SVB-SW	231933	1	✓	✓				
32 A				T3-3-15680/EA/SVB-SW	014375	1	✓	✓					
63 A				T5B-3-8901/EA/SVB-SW	207421	1	✓	✓					
100 A				T5-3-8901/EA/SVB-SW	207409	1	X	✓					
 1 0 2 0 3 0 4 0 5 0 6 0 N 0 13 0 14 0 21 0 22 0	3 + N	1	1	63 A	P3-63/EA/SVB-SW/N/HI11	069724	1	✓	✓				
100 A				P3-100/EA/SVB-SW/N/HI11	079216	1	✓	✓					
 1 0 2 0 3 0 4 0 5 0 6 0 7 0 8 0 9 0 10 0 11 0 12 0 13 0 14 0 15 0 16 0	6	1	1	20 A	T0-4-15682/EA/SVB-SW	022265	1	✓	✓				
32 A				T3-4-15682/EA/SVB-SW	057089	1	✓	✓					
63 A				T5B-4-15682/EA/SVB-SW	207426	1	✓	✓					
100 A				T5-4-15682/EA/SVB-SW	207414	1	X	✓					



231946

Photo is representative

# Flush mounting - Main switch-disconnectors with auxiliary contacts

## With emergency switch off/emergency stop function

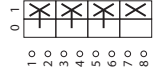
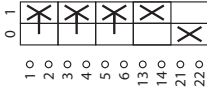
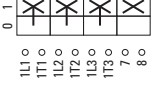
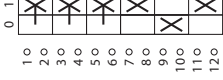
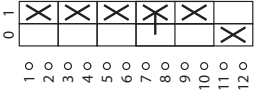
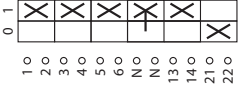
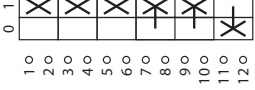
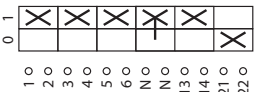
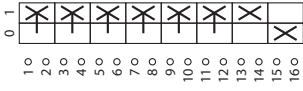
Front plate	Contact sequence	Number of poles	Auxiliary contacts		Rated current	Part number	Article number	Suitable for export to North America (US) and Canada	Padlockable handle
			N/O	N/C					
 FS 908		3	1	0	20 A	T0-2-15679/EA/SVB	081588	✓	✓
		3	1	1	25 A	P1-25/EA/SVB/HI11	091080	✓	✓
	32 A				P1-32/EA/SVB/HI11	072567	✓	✓	
	40 A				P1-40/EA/SVB/HI11	199895	X	✓	
	63 A				P3-63/EA/SVB/HI11	019891	✓	✓	
	100 A				P3-100/EA/SVB/HI11	029383	✓	✓	
		3	1	0	125 A	P5-125/EA/SVB/HI10	280899	✓	✓
	160 A				P5-160/EA/SVB/HI10	280923	✓	✓	
	250 A				P5-250/EA/SVB/HI10	280937	✓	✓	
	315 A				P5-315/EA/SVB/HI10	280951	✓	✓	
	3	2	1	20 A	T0-3-15683/EA/SVB	015571	✓	✓	
32 A				T3-3-15683/EA/SVB	040478	✓	✓		
	3 + N	1	1	20 A	T0-3-15680/EA/SVB	038875	✓	✓	
32 A				P1-25/EA/SVB/N/HI11	048367	✓	✓		
32 A				T3-3-15680/EA/SVB	012002	✓	✓		
	3 + N	1	1	32 A	P1-32/EA/SVB/N/HI11	057859	✓	✓	
40 A				P1-40/EA/SVB/N/HI11	199897	X	✓		
	3 + N	1	1	20 A	T0-3-8901/EA/SVB	231932	✓	✓	
32 A				T3-3-8901/EA/SVB	231945	✓	✓		
63 A				T5B-3-8901/EA/SVB	207420	✓	✓		
100 A				T5-3-8901/EA/SVB	207408	X	✓		
	3 + N	1	1	63 A	P3-63/EA/SVB/N/HI11	067351	✓	✓	
100 A				P3-100/EA/SVB/N/HI11	076843	✓	✓		
	6	1	1	20 A	T0-4-15682/EA/SVB	019892	✓	✓	
32 A				T3-4-15682/EA/SVB	054716	✓	✓		
63 A				T5B-4-15682/EA/SVB	207425	✓	✓		
100 A				T5-4-15682/EA/SVB	207413	✓	✓		







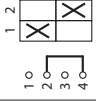
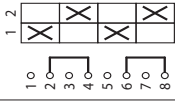
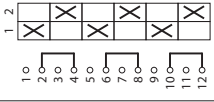
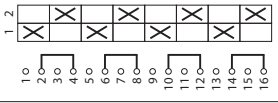
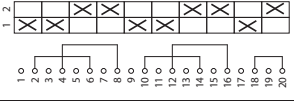
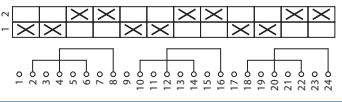

019891

Photo is representative

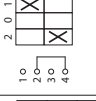
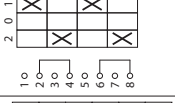
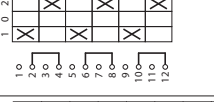
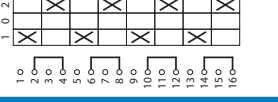
# Flush mounting - Changeover switch-disconnectors

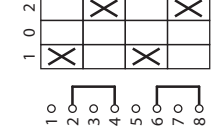
## Without emergency switch off/emergency stop function

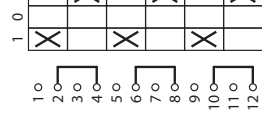
Front plate	Contact sequence	Number of poles N/O	Rated current	Part number	Article number	Pack qty	Suitable for export to North America (US and Canada)	Padlockable handle
<b>Without 0 (Off) position 60°</b>								
 F 072		1	10 A	TM-1-8220/E	081996	1	✓	X
		2	10 A	TM-2-8221/E	084369	1	✓	X
		3	10 A	TM-3-8222/E	086742	1	✓	X
		4	10 A	TM-4-8223/E	089115	1	✓	X
		5	10 A	TM-5-8369/E	091488	1	✓	X
		6	10 A	TM-6-8370/E	093861	1	✓	X
<b>With 0 (Off) position 60°</b>								
 F 071		1	10 A	TM-1-8210/E	096234	1	✓	X
		2	10 A	TM-2-8211/E	098607	1	✓	X
		3	10 A	TM-3-8212/E	010807	1	✓	X
		4	10 A	TM-4-8213/E	013180	1	✓	X
<b>With 0 (Off) position 90°</b>								
 F 057		2	10 A	TM-2-8219/E	017926	1	✓	X
 F 071		3	10 A	TM-3-8299/E	020299	1	✓	X



017926

Photo is representative

# Flush mounting - Changeover switch-disconnectors

## Without emergency switch off/emergency stop function

Front plate	Contact sequence	Number of poles N/O	Rated current	Part number	Article number	Pack qty	Suitable for export to North America (US and Canada)	Padlockable handle	
<b>With 0 (OFF) position</b>									
		1	20 A	T0-1-15421/E	095806	1	✓	✓	
FS 429									
		1	20 A	T0-1-8210/E	012742	1	✓	✓	
			32 A	T3-1-8210/E	054718	1	✓	✓	
			63 A	T5B-1-8210/E	094261	1	✓	✓	
FS 684									
		2	20 A	T0-2-15422/E	019871	1	✓	✓	
			FS 429						
		2	20 A	T0-2-8211/E	022234	1	✓	✓	
			32 A	T3-2-8211/E	061837	1	✓	✓	
			63 A	T5B-2-8211/E	093094	1	✓	✓	
FS 4011									
		3	20 A	T0-3-15423/E	034109	1	✓	✓	
			FS 429						
		3	20 A	T0-3-8212/E	029353	1	✓	✓	
			32 A	T3-3-8212/E	068956	1	✓	✓	
			63 A	T5B-3-8212/E	092386	1	✓	✓	
100 A	T5-3-8212/E	096466	1	X	✓				
FS 684									
		3	160 A	T6-3-8212/E/HI12	214781	1	X	✓	
			315 A	T8-3-8212/E/HI12	214782	1	X	✓	
			FS 684						
		4	32 A	T3-4-8902/E	215222	1	✓	✓	
			63 A	T5B-4-8902/E	207430	1	✓	✓	
			100 A	T5-4-8902/E	207418	1	✓	✓	
FS 161629									
		4	20 A	T0-4-8213/E	031726	1	✓	✓	
			32 A	T3-4-8213/E	076075	1	✓	✓	
			63 A	T5B-4-8213/E	092112	1	✓	✓	
100 A	T5-4-8213/E	096014	1	✓	✓				
FS 684									
		4	20 A	T0-4-8294/E	010371	1	✓	✓	
			32 A	T3-4-8294/E	002513	1	✓	✓	
			63 A	T5B-4-8294/E	092084	1	✓	✓	
100 A	T5-4-8294/E	095986	1	X	✓				
FS 953									



209353





019871



Photos are representative

# Flush mounting - Changeover switch-disconnectors

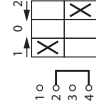
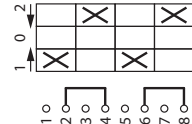
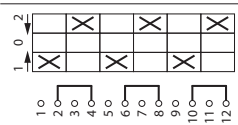
## Without emergency switch off/emergency stop function

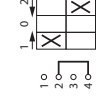
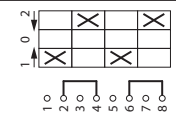
Front plate	Contact sequence	Number of poles N/O	Rated current	Part number	Article number	Pack qty	Suitable for export to North America (US and Canada)	Padlockable handle
<b>With Automatic (spring) return to 0 (OFF) position from both directions, without emergency off/emergency stop function</b>								
 FS 4011		1	20 A	T0-1-8214/E	019863	1	✓	X
			32 A	T3-1-8214/E	009632	1	✓	X
		2	20 A	T0-2-8215/E	022236	1	✓	X
			32 A	T3-2-8215/E	016751	1	✓	X
		3	20 A	T0-3-8216/E	024609	1	✓	X
			32 A	T3-3-8216/E	023870	1	✓	X
<b>Mini Cam switch-disconnector with Automatic (spring) return from both directions 30°</b>								
 F 025		1	10 A	TM-1-8214/E	032164	1	✓	X
			10 A	TM-2-8215/E	034537	1	✓	X
		2	10 A	TM-2-8215/E	034537	1	✓	X



022236





032164

Photos are representative

# Flush mounting - Changeover switch-disconnectors

## Without emergency switch off/emergency stop function

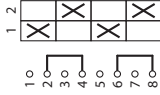
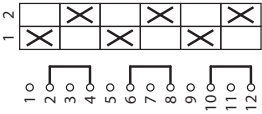
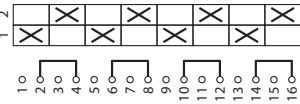
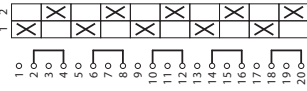
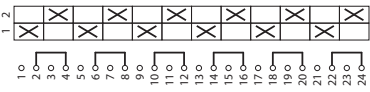
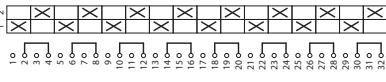
Front plate	Contact sequence	Number of poles N/O	Rated current	Part number	Article number	Pack qty	Suitable for export to North America (US and Canada)	Padlockable handle
Two way switch-disconnector without 0 (OFF) position								
 FS 943		1	20 A	T0-1-8220/E	<a href="#">031728</a>	1	✓	X
		2	20 A	T0-2-8221/E	<a href="#">038847</a>	1	✓	X
		32 A	T3-2-8221/E	<a href="#">045227</a>	1	✓	X	
		63 A	T5B-2-8221/E	<a href="#">093047</a>	1	✓	X	
		3	20 A	T0-3-8222/E	<a href="#">048339</a>	1	✓	X
		32 A	T3-3-8222/E	<a href="#">052346</a>	1	✓	X	
		63 A	T5B-3-8222/E	<a href="#">092378</a>	1	✓	X	
	4	20 A	T0-4-8223/E	<a href="#">050712</a>	1	✓	X	
	32 A	T3-4-8223/E	<a href="#">059465</a>	1	✓	X		
	63 A	T5B-4-8223/E	<a href="#">092108</a>	1	✓	X		
	5	20 A	T0-5-8369/E	<a href="#">060204</a>	1	✓	X	
	32 A	T3-5-8369/E	<a href="#">066584</a>	1	✓	X		
	6	20 A	T0-6-8370/E	<a href="#">062577</a>	1	✓	X	
	32 A	T3-6-8370/E	<a href="#">073703</a>	1	✓	X		
	8	20 A	T0-8-8372/E	<a href="#">064950</a>	1	✓	X	
	32 A	T3-8-8372/E	<a href="#">080822</a>	1	✓	X		







060204

Photo is representative

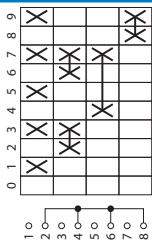
# Flush mounting - Coding switch-disconnectors

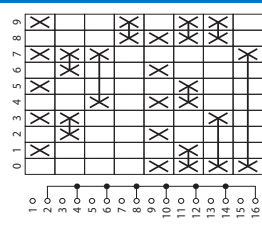
## Without emergency switch off/emergency stop function

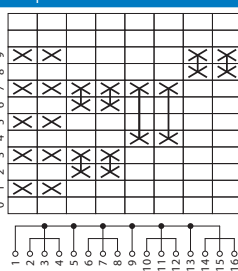
Front plate	Contact sequence	Rated current	Part number	Article number	Pack qty	Suitable for export to North America (US and Canada)	Padlockable handle
<b>BCD Code 0-9 30°</b>							
 F 007		10 A	TM-2-8550/E	020300	1	✓	X
<b>BCD Code 0-9 + complement 30°</b>							
 F 007		10 A	TM-4-8552/E	025046	1	✓	X
<b>BCD Code with complete rotation in both directions</b>							
 FS 312		20 A	T0-4-15602/E	029368	1	✓	X



020300



025046



029368

Photos are representative



# Flush mounting - Manual/auto switch-disconnectors

## Without emergency switch off/emergency stop function

Front plate	Contact sequence	Number of poles N/O	Rated current	Part number	Article number	Pack qty	Suitable for export to North America (US and Canada)	Padlockable handle
<b>60° Switching angle</b>								
		1	10 A	TM-1-15431/E	025045	1	✓	X
F 085		2	10 A	TM-2-15432/E	027418	1	✓	X
		3	10 A	TM-3-15433/E	029791	1	✓	X
<b>With 0 (Off) position</b>								
		1	20 A	T0-1-15431/E	019872	1	✓	X
FS 1401		2	20 A	T0-2-15432/E	034110	1	✓	X
		3	20 A	T0-3-15433/E	048348	1	✓	X
<b>With Automatic (spring) return from HAND</b>								
		1	20 A	T0-1-15434/E	062586	1	✓	X
FS 1414000		2	20 A	T0-2-15435/E	003191	1	✓	X
<b>With Automatic (spring) return from START</b>								
		2	20 A	T0-2-15907/E	066931	1	✓	X
FS 1413890		3	20 A	T0-3-15453/E	015127	1	✓	X
<b>Without 0 (Off) position</b>								
		1	20 A	T0-1-15451/E	076824	1	✓	X
FS 19334		2	20 A	T0-2-15452/E	091062	1	✓	X
		3	20 A	T0-3-15453/E	015127	1	✓	X







066931

Photo is representative

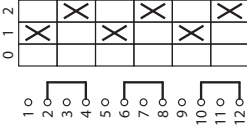
# Flush mounting - Multi speed switch-disconnectors

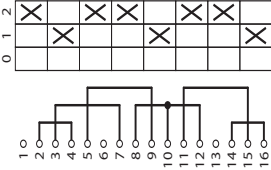
## Without emergency switch off/emergency stop function

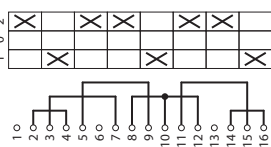
Front plate	Contact sequence	Number of poles N/O	Rated current	Part number	Article number	Pack qty	Suitable for export to North America (US and Canada)	Padlockable handle
<b>2 speed, non reversing, for 2 separate windings</b>								
 FS 644		6	20 A	T0-3-8451/E	<a href="#">038849</a>	1	✓	X
			32 A	T3-3-8451/E	<a href="#">028641</a>	1	✓	X
			63 A	T5B-3-8451/E	<a href="#">092288</a>	1	✓	X
<b>2 speed, 2 directions, for one tapped winding</b>								
 FS 644		3	20 A	T0-4-8440/E	<a href="#">041222</a>	1	✓	X
			32 A	T3-4-8440/E	<a href="#">035760</a>	1	✓	X
			63 A	T5B-4-8440/E	<a href="#">092032</a>	1	✓	X
 FS 684		3	20 A	T0-4-8441/E	<a href="#">043595</a>	1	✓	X
			32 A	T3-4-8441/E	<a href="#">042879</a>	1	✓	X
			63 A	T5B-4-8441/E	<a href="#">092028</a>	1	✓	X







038849

Photo is representative

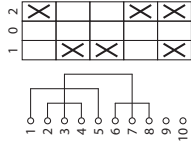
# Flush mounting - Reversing switch-disconnectors

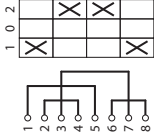
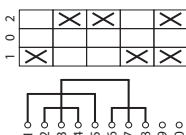
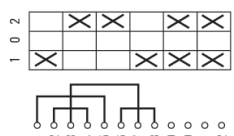
## Without emergency switch off/emergency stop function

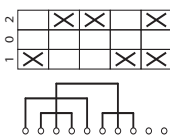
Front plate	Contact sequence	Number of poles N/O	Rated current	Part number	Article number	Pack qty	Suitable for export to North America (US and Canada)	Padlockable handle	
<b>Reversing switches 60°</b>									
 F 071		3	10 A	TM-3-8401/E	015554	1	✓	X	
<b>Without Automatic (spring) return to 0 (Off) position,</b>									
 FS 684		2	20 A	T0-2-8400/E	053079	1	✓	X	
			32 A	T3-2-8400/E	073695	1	✓	X	
			63 A	T5B-2-8400/E	092918	1	✓	X	
		3	20 A	T0-3-8401/E	091047	1	✓	X	
			32 A	T3-3-8401/E	030992	1	✓	X	
			63 A	T5B-3-8401/E	092296	1	✓	X	
		4	20 A	T0-4-74949GB/E	400000	1	✓	X	
			32 A	T3-4-74949GB/E	400001	1	✓	X	
			63 A	T5B-4-74949GB/E	400002	1	✓	X	
	<b>With Automatic (spring) return from both directions to 0 (Off) position)</b>								
	 FS 4011		3	20 A	T0-3-8228/E	015112	1	✓	X
				32 A	T3-3-8228/E	002538	1	✓	X
63 A				T5B-3-8228/E	092374	1	✓	X	







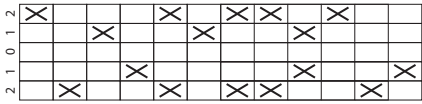
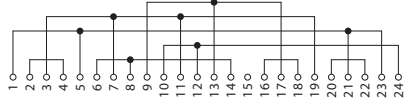

015554

Photo is representative

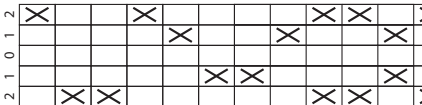
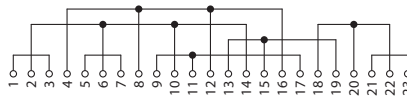
# Flush mounting - Reversing switch-disconnectors

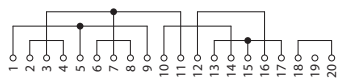
## Without emergency switch off/emergency stop function

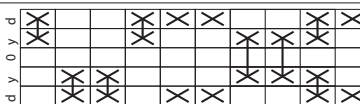
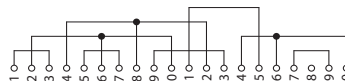
Front plate	Contact sequence	Number of poles N/O	Rated current	Part number	Article number	Pack qty	Suitable for export to North America (US and Canada)	Padlockable handle
<b>2 speed, 2 directions, for one tapped winding</b>								
 FS 629			20 A	T0-6-15866/E	055460	1	✓	X
			32 A	T3-6-15866/E	054744	1	✓	X
 FS 441			63 A	T5B-7-15866/E	214788	1	✓	X
								
<b>Star delta, two-way operating direction</b>								
 FS 638		3	20 A	T0-5-15876/E	000893	1	✓	X
			32 A	T3-5-15876/E	016776	1	✓	X
 FS 4017		3	63 A	T5B-5-15876/E	214785	1	✓	X
								











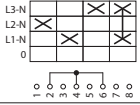

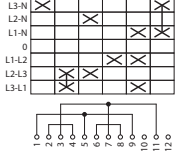
214785

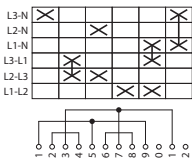
Photo is representative

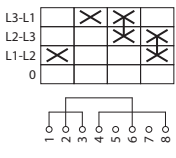
# Flush mounting - Selector switch-disconnectors

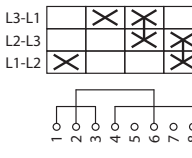
## Without emergency switch off/emergency stop function

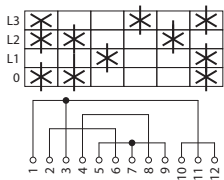
Front plate	Contact sequence	Number of poles	Rated current	Part number	Article number	Pack qty	Suitable for export to North America (US and Canada)	Padlockable handle
<b>Voltmeter</b>								
		3 x phase-N with 0 position	20 A	T0-2-15921/E	067337	1	✓	X
FS 1410757								
		3 x phase-phase 3 x phase-N with 0 position	20 A	T0-3-8007/E	095813	1	✓	X
FS 1410759								
		3 x phase-phase 3 x phase-N without 0 position with complete rotation in both directions	20 A	T0-3-15924/E	019878	1	✓	X
FS 164721								
		3 x phase-phase with 0 position	20 A	T0-2-15920/E	038861	1	✓	X
FS 1410755								
		3 x phase-phase without 0 position	20 A	T0-2-15922/E	053099	1	✓	X
FS 164854								
<b>Ammeter with complete rotation in both directions, measurement via current transformer, with 0 (OFF) position</b>								
		X	20 A	T0-3-8048/E	034116	1	✓	X
FS 9440								



095813

Photo is representative

# Flush mounting - Star-delta switch-disconnectors

## Without emergency switch off/emergency stop function

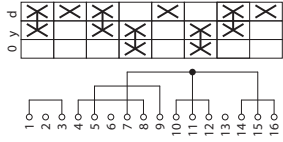
Front plate	Contact sequence	Number of poles N/O	Rated current	Part number	Article number	Pack qty	Suitable for export to North America (US and Canada)	Padlockable handle
 FS 635		3	20 A	T0-4-8410/E	<a href="#">024604</a>	1	✓	X
			32 A	T3-4-8410/E	<a href="#">009657</a>	1	✓	X
			63 A	T5B-4-8410/E	<a href="#">092052</a>	1	✓	X











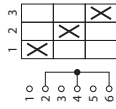

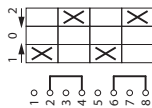

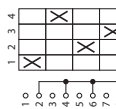

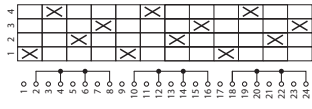
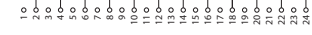
092052

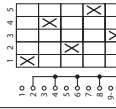
Photo is representative

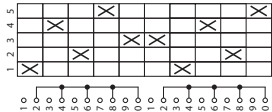
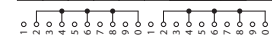
# Flush mounting - Step switch-disconnectors

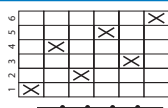
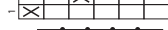
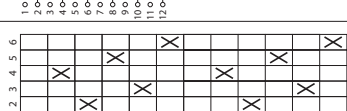
## Without emergency switch off/emergency stop function

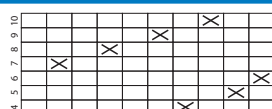
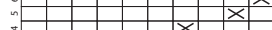
Front plate	Contact sequence	N/O	Number of poles	Rated current	Part number	Article number	Pack qty	Suitable for export to North America (US and Canada)	Padlockable handle
<b>3 steps 60°</b>									
			1	10 A	TM-2-8230/E	039283	1	✓	X
F 076									
			3	10 A	TM-5-8270/E	041656	1	✓	X
									
<b>4 steps 60°</b>									
			1	10 A	TM-2-8231/E	044029	1	✓	X
F 077									
			3	10 A	TM-6-8271/E	046402	1	✓	X
									
<b>5 steps 60°</b>									
			1	10 A	TM-3-8232/E	039298	1	✓	X
F 078									
			2	10 A	TM-5-8252/E	041671	1	✓	X
									
<b>6 steps 60°, no full rotation</b>									
			1	10 A	TM-3-8233/E	053521	1	✓	X
F 079									
			2	10 A	TM-6-8253/E	055894	1	✓	X
									
<b>10 steps 30°</b>									
			1	10 A	TM-5-8237/E	069150	1	✓	X
									









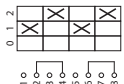

041671

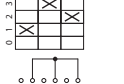
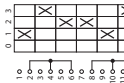
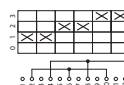
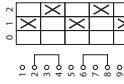
Photo is representative

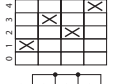
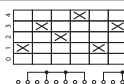
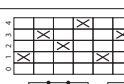
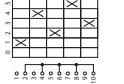
# Flush mounting - Step switch-disconnectors

## Without emergency switch off/emergency stop function

Front plate	Contact sequence	Rated current	Number of poles	Part number	Article number	Pack qty	Suitable for export to North America (US and Canada)	Padlockable handle
<b>2 steps 60°</b>								
 F 075		10 A	1	TM-1-8240/E	058267	1	✓	X
		10 A	2	TM-2-8260/E	060640	1	✓	X
<b>3 steps 45°</b>								
 F 109		10 A	1	TM-2-8241/E	065386	1	✓	X
		10 A	2	TM-3-8261/E	067759	1	✓	X
		10 A	3	TM-5-8281/E	070132	1	✓	X
<b>3 steps 60°</b>								
 F 075		10 A	3	TM-3-8280/E	063013	1	✓	X
<b>4 steps 30°</b>								
 F 002		10 A	1	TM-3-8242/E	072505	1	✓	X
		10 A	2	TM-4-8262/E	074878	1	✓	X
		10 A	3	TM-6-8282/E	077251	1	✓	X
<b>5 steps 30°</b>								
 F 003		10 A	1	TM-3-8243/E	079624	1	✓	X
<b>6 steps 30°</b>								
 F 004		10 A	1	TM-3-8244/E	081997	1	✓	X
<b>9 steps 30°</b>								
 F 007		10 A	1	TM-5-8247/E	009741	1	✓	X













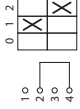

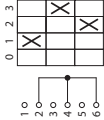

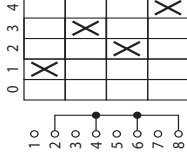
072505

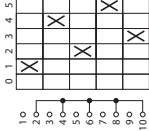
Photo is representative

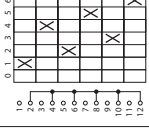

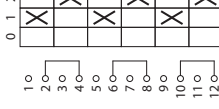
# Flush mounting - Step switch-disconnectors

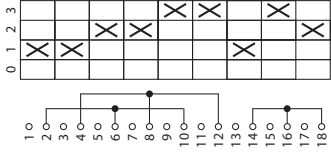
## Without emergency switch off/emergency stop function

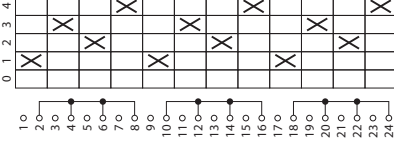
Front plate	Contact sequence	Number of poles N/O	Rated current	Part number	Article number	Pack qty	Suitable for export to North America (US and Canada)	Padlockable handle
With 0 (Off) position								
 FS 418		1	20 A	T0-1-8240/E	<a href="#">034105</a>	1	✓	X
 FS 420		1	20 A	T0-2-8241/E	<a href="#">050716</a>	1	✓	X
 FS 422		1	20 A	T0-2-8242/E	<a href="#">067327</a>	1	✓	X
 FS 424		1	20 A	T0-3-8243/E	<a href="#">081565</a>	1	✓	X
 FS 426		1	20 A	T0-3-8244/E	<a href="#">095803</a>	1	✓	X
 FS 418		3	20 A	T0-3-8280/E	<a href="#">034106</a>	1	✓	X
 FS 420		3	20 A	T0-5-8281/E	<a href="#">048344</a>	1	✓	X
 FS 422		3	20 A	T0-6-8282/E	<a href="#">062582</a>	1	✓	X











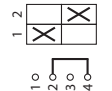

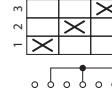

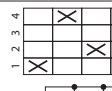

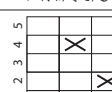

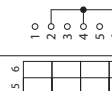
062582

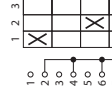
Photo is representative

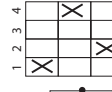
# Flush mounting - Step switch-disconnectors

## Without emergency switch off/emergency stop function

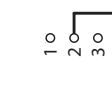
Front plate	Contact sequence	Number of poles N/O	Rated current	Part number	Article number	Pack qty	Suitable for export to North America (US and Canada)	Padlockable handle
Without O (Off) position								
 FS 943		1	20 A	T0-1-8220/E	<a href="#">031728</a>	1	✓	X
 FS 404		1	20 A	T0-2-8230/E	<a href="#">088685</a>	1	✓	X
 FS 606		1	20 A	T0-2-8231/E	<a href="#">012750</a>	1	✓	X
 FS 408		1	20 A	T0-3-8232/E	<a href="#">026988</a>	1	✓	X
 FS 410		1	20 A	T0-3-8233/E	<a href="#">041226</a>	1	✓	X
 FS 406		2	20 A	T0-4-8251/E	<a href="#">013971</a>	1	✓	X
 FS 943		3	20 A	T0-3-8222/E	<a href="#">048339</a>	1	✓	X
 FS 404		3	20 A	T0-5-8270/E	<a href="#">091059</a>	1	✓	X
 FS 406		3	20 A	T0-6-8271/E	<a href="#">015124</a>	1	✓	X



091059

Photo is representative

# Flush mounting - Step switch-disconnectors for heating

## Without emergency switch off/emergency stop function

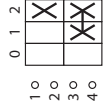
Front plate	Contact sequence	Rated current	Number of poles N/O	Part number	Article number	Pack qty	Suitable for export to North America (US and Canada)	Padlockable handle
With 0 (OFF) position								
 FS 614		20 A	1	T0-1-91/E	072082	1	✓	X



072082

Photo is representative

# Flush mounting - Universal control switch-disconnectors

## Without emergency switch off/emergency stop function

Front plate	Contact sequence	Rated current	Part number	Article number	Pack qty	Suitable for export to North America (US and Canada)	Padlockable handle
<b>Maintained switches with 3 positions</b> 1 Contact closed in each position - Additionally 1 contact closed in position 0 and 1 - Additionally 1 contact closed in position 0 and 2 - Additionally 1 contact closed in position 0 and 3							
		20 A	T0-3-15391/E	029365	1	✓	X
FS 429							
<b>Automatic (spring) return from positions 1 and 2</b>							
		20 A	T0-3-15394/E	072079	1	✓	X
FS 458							



072079

Photo is representative

# Flush mounting dedicated accessories

## Neutral terminal

Early make on switching, late-break off switching.

The N contact always behaves as an early make contact when switching on and as a late break when switching off. N-P1(P3)... switching capacity same as for contacts P1(P3)

Description	Part number	Article number	Std. pack	Suitable for export to North America (US and Canada)*	Suitable for
Neutral terminal - for left or right side mounting	N-P1E	000651	5	✓	P1
Neutral terminal	N-P3E	062432	5	✓	P3



062432

## Neutral terminal

Description	Part number	Article number	Std. pack	Suitable for export to North America (US and Canada)*	Suitable for
Front mounting, left	N-P5-125/160E	280969	1	✓	P5-125 (160)/E(EA)
	N-P5-250/315E	280971	1	✓	P5-250/315/E(EA)



280969

## Ground terminal

Description	Part number	Article number	Std. pack	Suitable for export to North America (US and Canada)*	Suitable for
Front mounting, left	PE-P5-125/160E	280973	1	✓	P5-125 (160)/E(EA)
	PE-P5-250/315E	280975	1	✓	P5-250/315/E(EA)



280973

## Auxiliary contacts - 1 normally open (N/O), 1 normally close (N/C)

- Late break on switching, early-make off switching. The N/O is always connected as a load-shedding contact

Description	Part number	Article number	Std. pack	Suitable for export to North America (US and Canada)	Suitable for	Mounting
For left or right side mounting	HI11-PI/P3E	061813	5	✓	P1	Flush mounting /E or /EA
					P3	Flush mounting /E or /EA

Product standards	UL 60947-4-1, CSA - C22-2 No 14-05 IEC/EN 60947-3, CE Marking
UL File No	E36332
UL CCN	NLRV
CSA File No	12528
CSA Class No	3211-05
NA Certification	UL Listed, CSA Certified



## Auxiliary contacts - 2 normally open (N/O), 1 normally close (N/C)

Description	Part number	Article number	Std. pack	Suitable for export to North America (US and Canada)	Suitable for	Mounting
For left or right side mounting	HI21-P5-125/160E	280963	1		P5-125 and 160	Flush mounting /EA or /E
	HI21-P5-250/315E	280965	1		P5-250 and 315	Flush mounting /EA or /E



Photos are representative

# Flush mounting dedicated accessories

## Flush mounting to centre mounting convertor

- For single hole fitting 22.3 mm
- To convert a Flush mounting switch into a Centre mounting switch

Description	Part number	Article number	Std. pack	Suitable for export to North America (US and Canada)*	Suitable for	Mounting
For cam switches with existing front plate - quick installation with snap fitting system	EZ-T0	081622	1	✓	T0, T3	Flush mounting /E
Mounting diameter 22.3 mm, one man mounting with screw fixing	EZ-P1	091455	1	✓	T0, T3, P1	Flush mounting /E



081622



091455

\* UL/CSA certification not required

## Shrouds

Description	Part number	Article number	Std. pack	Suitable for export to North America (US and Canada)*	Suitable for	Mounting
For flush mounting switches with up to 4 contact units Cable entries Quantity: 2 x Ø 20 mm + 2 x Ø 15 mm Cross section: 5 x 6 mm <sup>2</sup> , 5 x 2.5 mm <sup>2</sup>	H3-T0	093828	1	✓	T0, T3	Flush mounting /E



093828

\* UL/CSA certification not required

## IP65 Insulated enclosures

Description	Number of contact units	Part number	Article number	Std. pack	Suitable for export to North America (US and Canada)	Suitable for	Mounting
IP65 insulated enclosure - With metric knockouts	1-2	CI-K4-T5B-2*	207439	1	✓	T5B	Flush mounting /E

\* For converting T5../Z into T5../I5 and T5B../E into T5B../I4, order AW-T5-... extension terminal additionally. 1 contact unit = 2 contacts

Product standards	UL 60947-4-1 CSA - C22-2 No 14-05, CSA - C22-2 No 94 IEC/EN 60947-3 CE Marking
UL File No	E54120
UL CCN	MITW2
CSA File No	12528
CSA Class No	3211-07
NA Certification	UL Listed, CSA Certified
Degree of protection	IEC: IP65 UL/CSA Type 1, 3R, 4X, 12, 13 - indoor and outdoor use



207439

Photos are representative

# Centre mounting switch-disconnectors

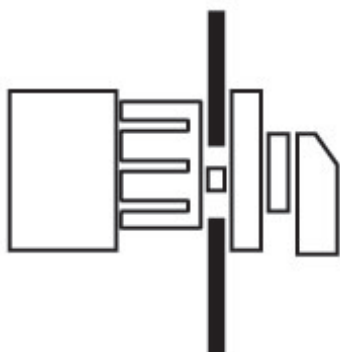

## Description

Centre mounting switch-disconnectors can be easily installed, using 22.5 mm single-hole mounting, onto doors, panels, lids, enclosures in machinery, switchboard and switchgear.

## Standards/Approvals

See details page 178

## Technical data

- Voltage: 690 V a.c.
- Current: 10 A to 40 A
- Mounting method: 22.5 mm single-hole mounting

## Features

- Available with or without emergency switching off/emergency stop function
- Available with and without auxiliary contacts
- Available with red rotary handle and yellow locking collar and black rotary handle and locking collar
- 1-pole to 8-pole options



TM Center mounting



T0 Center mounting

Photos are representative













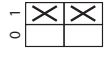
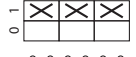
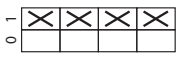













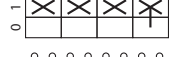

## Centre mounting - Range overview

Rated current	10 A	20 A	25 A	32 A	40 A	
On-Off switch-disconnectors	TM	T0	P1	P1	T3	P1
Without auxiliary contacts	✓	✓	✓	✓	✓	✓
With auxiliary contacts		✓			✓	
Changeover switch-disconnectors	TM	T0			T3	
Without auxiliary contacts	✓	✓			✓	
Coding switch-disconnectors	TM					
Without auxiliary contacts	✓					
Control switch-disconnectors		T0				
Without auxiliary contacts		✓				
Heater switch-disconnectors		T0				
Without auxiliary contacts		✓				
Group switch-disconnectors	TM					
Without auxiliary contacts	✓					
Manual/auto switch-disconnectors	TM	T0				
Without auxiliary contacts	✓	✓				
Multi speed switch-disconnectors		T0			T3	
Without auxiliary contacts		✓			✓	
Reversing switch-disconnectors		T0			T3	
Without auxiliary contacts		✓			✓	
Reversing star delta switch-disconnectors		T0			T3	
Without auxiliary contacts		✓			✓	
Selector switch-disconnectors		T0				
Without auxiliary contacts		✓				
Step switch-disconnectors	TM	T0				
Without auxiliary contacts	✓	✓				

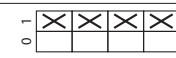

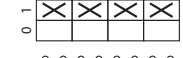
# Centre mounting - On-Off switch-disconnectors without auxiliary contacts

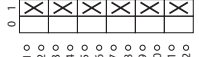
## Without emergency switch off/emergency stop function

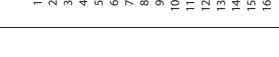
Front plate	Contact sequence	Number of poles	Rated current	Part number	Article number	Pack qty	Suitable for export to North America (US and Canada)	Padlockable handle
 F 056		1	10 A	TM-1-8290/EZ	<a href="#">000693</a>	1	✓	X
		2	10 A	TM-1-8291/EZ	<a href="#">015073</a>	1	✓	X
		3	10 A	TM-2-8292/EZ	<a href="#">015096</a>	1	✓	X
		3+N	10 A	TM-2-8293/EZ	<a href="#">045486</a>	1	✓	X
 FS 415		1	20 A	T0-1-15401/EZ	<a href="#">041227</a>	1	✓	X
 FS 908		1	20 A	T0-1-8200/EZ	<a href="#">069725</a>	1	✓	X
			32 A	T3-1-8200/EZ	<a href="#">066581</a>	1	✓	X
 FS 415		2	20 A	T0-1-15402/EZ	<a href="#">055465</a>	1	✓	X
 FS 908		2	20 A	T0-1-102/EZ	<a href="#">091082</a>	1	✓	X
			32 A	T3-1-102/EZ	<a href="#">078446</a>	1	✓	X
 FS 415		3	20 A	T0-2-15403/EZ	<a href="#">069703</a>	1	✓	X
 FS 908		3	20 A	T0-2-1/EZ	<a href="#">027012</a>	1	✓	X
			25 A	P1-25/EZ	<a href="#">041250</a>	1	✓	X
			32 A	P1-32/EZ	<a href="#">048369</a>	1	✓	X
			40 A	P1-40/EZ	<a href="#">199903</a>	1	X	X
		3 + N	20 A	T0-2-8900/EZ	<a href="#">207402</a>	1	✓	X
			25 A	P1-25/EZ/N	<a href="#">079218</a>	1	✓	X
			32 A	P1-32/EZ/N	<a href="#">095829</a>	1	✓	X
			40 A	P1-40/EZ/N	<a href="#">199904</a>	1	X	X
 FS 415		4	20 A	T0-2-15404/EZ	<a href="#">083941</a>	1	✓	X
 FS 908		6	20 A	T0-3-8342/EZ	<a href="#">045997</a>	1	✓	X
 FS 908		8	20 A	T0-4-8344/EZ	<a href="#">014002</a>	1	✓	X
			32 A	T3-4-8344/EZ	<a href="#">020595</a>	1	✓	X











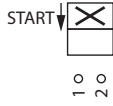

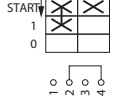
015073

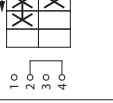
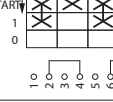
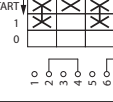
Photo is representative

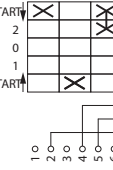
# Centre mounting - On-Off switch-disconnectors without auxiliary contacts

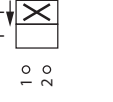
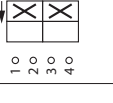
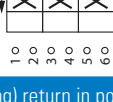
## Without emergency switch off/emergency stop function

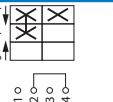
Front plate	Contact sequence	Poles N/O	Rated current	Part number	Article number	Pack qty	Suitable for export to North America (US and Canada)	Padlockable handle
<b>ON Switch 30°</b>								
 F 023		1	10 A	TM-1-8175/EZ	015690	1	✓	X
<b>ON OFF Switch 90°/30° - With Automatic (spring) return to 1</b>								
 F 119		1	10 A	TM-1-8178/EZ	016786	1	✓	X
<b>ON OFF Switch 90°/30° - With Automatic (spring) return in START position</b>								
 FS 147767		1	20 A	T0-1-15511/EZ	022248	1	✓	X
		2	20 A	T0-2-15512/EZ	036486	1	✓	X
		3	20 A	T0-3-15513/EZ	050724	1	✓	X
 FS 140660		2	20 A	T0-2-8177/EZ	017503	1	✓	X
<b>Automatic (spring) return from position 1</b>								
 FS 4721		1	20 A	T0-1-15321/EZ	088690	1	✓	X
		2	20 A	T0-1-15322/EZ	012755	1	✓	X
		3	20 A	T0-2-15323/EZ	026993	1	✓	X
<b>Automatic (spring) return in position 1 and 0</b>								
 FS 456		1	20 A	T0-1-15366/EZ	083945	1	✓	X



016786



036486



012755

Photos are representative

## Centre mounting - On-Off switch-disconnectors without auxiliary contacts

### With emergency switch off/emergency stop function

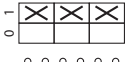



Front plate	Contact sequence	Number of poles N/O	Rated current	Part number	Article number	Pack qty	Suitable for export to North America (US and Canada)	Padlockable handle
 FS 908	 1 2 3 4 5 6	3	40 A	P1-40/EZ/RT	19905	1	X	X



199905

## Centre mounting - On-Off switch-disconnectors with auxiliary contacts

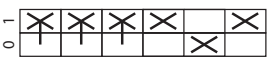
### Without emergency switch off/emergency stop function

Front plate	Contact sequence	Number of poles N/O	Auxiliary contacts N/O N/C	Rated current	Part number	Article number	Pack qty	Suitable for export to North America (US and Canada)	Padlockable handle
 FS 908	 1 2 3 4 5 6 7 8	3	1 0	20 A	T0-2-15679/EZ	031760	1	✓	X
	 1 2 3 4 5 6 7 8 9 10 11 12	3	2 1	20 A	T0-2-15683/EZ	016658	1	✓	X
	 1 2 3 4 5 6 7 8 9 10 11 12	3+N	1 1	20 A	T0-3-8901/EZ	231939	1	✓	X
				32 A	T3-3-8901/EZ	231950	1	✓	X
	 1 2 3 4 5 6 7 8 9 10 11 12 13 14 15 16	6	1 1	20 A	T0-4-15682/EZ	012778	1	✓	X



231950

Photos are representative

# Centre mounting - Changeover switch-disconnectors

## Without emergency switch off/emergency stop function

Front plate	Contact sequence	Number of poles N/O	Rated current	Part number	Article number	Pack qty	Suitable for export to North America (US and Canada)	Padlockable handle
<b>With 0 (OFF) position</b>								
		1	20 A	T0-1-15421/EZ	098179	1	✓	X
FS 429								
		1	20 A	T0-1-8210/EZ	048337	1	✓	X
FS 684								
		1	20 A	T0-1-8214/EZ	076815	1	✓	X
FS 4011								
		2	20 A	T0-2-15422/EZ	022244	1	✓	X
FS 429								
		2	20 A	T0-2-8211/EZ	053083	1	✓	X
FS 684								
		2	32 A	T3-1-8210/EZ	003072	1	✓	X
		3	20 A	T0-3-15423/EZ	036482	1	✓	X
FS 429								
		3	20 A	T0-3-8212/EZ	057829	1	✓	X
FS 684								
		4	32 A	T3-4-8902/EZ	215223	1	✓	X
FS 161629								
		4	20 A	T0-4-8213/EZ	062575	1	✓	X
FS 684								
		4	32 A	T3-4-8213/EZ	003079	1	✓	X
		4	20 A	T0-4-8294/EZ	072069	1	✓	X
FS 953								
<b>With Automatic (spring) return to the 0 (OFF) position from both directions</b>								
		1	20 A	T0-1-8214/EZ	076815	1	X	X
FS 4011								
		2	20 A	T0-2-8215/EZ	081561	1	✓	X
		3	20 A	T0-3-8216/EZ	086307	1	✓	X





215223

Photo is representative

# Centre mounting - Changeover switch-disconnectors

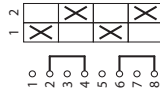
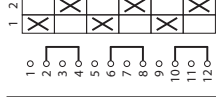
## Without emergency switch off/emergency stop function

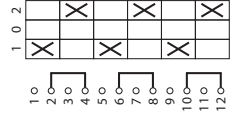
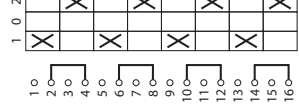
Front plate	Contact sequence	Number of poles N/O	Rated current	Part number	Article number	Pack qty	Suitable for export to North America (US and Canada)	Padlockable handle
<b>Without 0 (OFF) position 60°</b>								
		1	10 A	TM-1-8220/EZ	000692	1	✓	X
F 072		2	10 A	TM-2-8221/EZ	015197	1	✓	X
		3	10 A	TM-3-8222/EZ	045493	1	✓	X
		4	10 A	TM-4-8223/EZ	046119	1	✓	X
		5	10 A	TM-5-8369/EZ	046126	1	✓	X
<b>With 0 (OFF) position 60°</b>								
		1	10 A	TM-1-8210/EZ	015137	1	✓	X
F 071		2	10 A	TM-2-8211/EZ	015166	1	✓	X
		3	10 A	TM-3-8212/EZ	045491	1	✓	X
		4	10 A	TM-4-8213/EZ	045847	1	✓	X





045491

Photo is representative

# Centre mounting - Changeover switch-disconnectors

## Without emergency switch off/emergency stop function

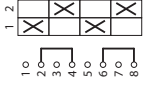
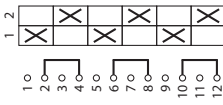
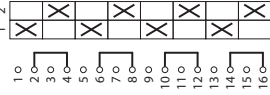
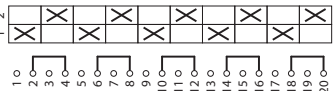
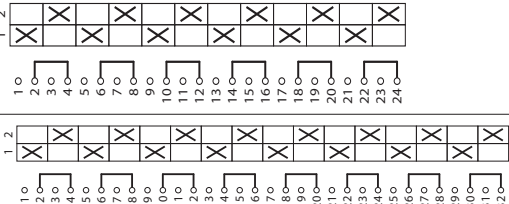
Front plate	Contact sequence	Number of poles	Rated current	Part number	Article number	Pack qty	Suitable for export to North America (US and Canada)	Padlockable handle
Two way switch, without emergency switching off/emergency stop function								
 FS 943		1	20 A	T0-1-8220/EZ	<a href="#">095799</a>	1	✓	X
		20 A	T0-2-8221/EZ	<a href="#">010372</a>	1	✓	X	
		32 A	T3-2-8221/EZ	<a href="#">001025</a>	1	✓	X	
		20 A	T0-3-8222/EZ	<a href="#">015118</a>	1	✓	X	
		32 A	T3-3-8222/EZ	<a href="#">001069</a>	1	✓		
		20 A	T0-4-8223/EZ	<a href="#">019864</a>	1	✓	X	
		20 A	T0-5-8369/EZ	<a href="#">024610</a>	1	✓	X	
	20 A	T0-6-8370/EZ	<a href="#">029356</a>	1	✓	X		
	32 A	T3-6-8370/EZ	<a href="#">004506</a>	1	✓	X		
	20 A	T0-8-8372/EZ	<a href="#">034102</a>	1	✓			





024610

Photo is representative

# Centre mounting - Coding switch-disconnectors

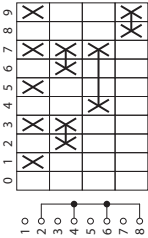
## Without emergency switch off/emergency stop function

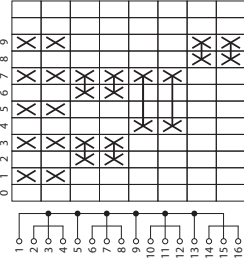
Front plate	Contact sequence	Rated current	Part number	Article number	Pack qty	Suitable for export to North America (US and Canada)	Padlockable handle
BCD Code 0-9 30°							
 F 007		10 A	TM-2-8550/EZ	000699	1	✓	X
BCD Code 0-9 30° with complete rotation in both directions							
 FS 312		20 A	T0-4-15602/EZ	031741	1	✓	X



000699





031741

Photos are representative

# Centre mounting - Control switch-disconnectors

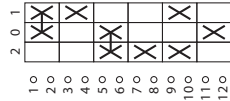
## Without emergency switch off/emergency stop function

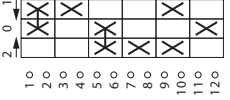
Front plate	Contact sequence	Rated current	Part number	Article number	Pack qty	Suitable for export to North America (US and Canada)	Padlockable handle
<b>Maintained switches with 3 positions</b> 1 Contact closed in each position - Additionally 1 contact closed in position 0 and 1 - Additionally 1 contact closed in position 0 and 2 - Additionally 1 contact closed in position 0 and 3							
 FS 429		20 A	T0-3-15391/EZ	031738	1	✓	X
<b>Automatic (spring) return from positions 1 and 2</b>							
 FS 458		20 A	T0-3-15394/EZ	074452	1	✓	X



031738



# Centre mounting - Group switch-disconnectors

## Without emergency switch off/emergency stop function

Front plate	Contact sequence	Pole N/O	Rated current	Part number	Article number	Pack qty	Suitable for export to North America (US and Canada)	Padlockable handle
<b>2 groups 60°</b>								
		3+N	10 A	TM-1-8310/EZ	045479	1	✓	X
F 075								
<b>3 groups 30°</b>								
		3+N	10 A	TM-1-8311/EZ	045487	1	✓	X
F 001								



045487

Photo is representative

# Centre mounting - Manual/auto switch-disconnectors

Front plate	Contact sequence	Number of poles N/O	Rated current	Part number	Article number	Pack qty	Suitable for export to North America (US and Canada)	Padlockable handle
 F 288	AUTO: [X] [X] HAND: [X] [X] Wiring: 1-2, 3-4	1	10 A	TM-1-8220F88/EZ	016925	1	✓	X
 F 085	AUTO: [X] [X] HAND: [X] [X] Wiring: 1-2, 3-4	1	10 A	TM-1-15431/EZ	000691	1	✓	X
	AUTO: [X] [X] [X] HAND: [X] [X] [X] Wiring: 1-2, 3-4, 5-6, 7-8	2	10 A	TM-2-15432/EZ	016878	1	✓	X
	AUTO: [X] [X] [X] [X] HAND: [X] [X] [X] [X] Wiring: 1-2, 3-4, 5-6, 7-8, 9-10, 11-12	3	10 A	TM-3-15433/EZ	045490	1	✓	X
<b>With 0 (Off) position</b>								
 FS 1401	AUTO: [X] [X] HAND: [X] [X] Wiring: 1-2, 3-4	1	20 A	T0-1-15431/EZ	022245	1	✓	X
	AUTO: [X] [X] [X] HAND: [X] [X] [X] Wiring: 1-2, 3-4, 5-6, 7-8	2	20 A	T0-2-15432/EZ	036483	1	✓	X
	AUTO: [X] [X] [X] [X] HAND: [X] [X] [X] [X] Wiring: 1-2, 3-4, 5-6, 7-8, 9-10, 11-12	3	20 A	T0-3-15433/EZ	050721	1	✓	X
<b>With Automatic (spring) return from HAND</b>								
 FS 1414000	AUTO: [X] [X] HAND: [X] [X] Wiring: 1-2, 3-4	1	20 A	T0-1-15434/EZ	018053	1	✓	X
	AUTO: [X] [X] [X] HAND: [X] [X] [X] Wiring: 1-2, 3-4, 5-6, 7-8	2	20 A	T0-2-15435/EZ	003192	1	✓	X
<b>With Automatic (spring) return from START</b>								
 FS 1413890	START: [X] [X] HAND: [X] [X] AUTO: [X] [X] Wiring: 1-2, 3-4, 5-6, 7-8	2	20 A	T0-2-15907/EZ	069304	1	✓	X
<b>Without 0 (Off) position</b>								
 FS 19334	AUTO: [X] [X] HAND: [X] [X] Wiring: 1-2, 3-4	1	20 A	T0-1-15451/EZ	079197	1	✓	X
	AUTO: [X] [X] [X] HAND: [X] [X] [X] Wiring: 1-2, 3-4, 5-6, 7-8	2	20 A	T0-2-15452/EZ	093435	1	✓	X
	AUTO: [X] [X] [X] [X] HAND: [X] [X] [X] [X] Wiring: 1-2, 3-4, 5-6, 7-8, 9-10, 11-12	3	20 A	T0-3-15453/EZ	017500	1	✓	X



045490







079197

Photos are representative

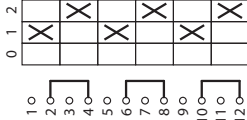
# Centre mounting - Multi speed switch-disconnectors

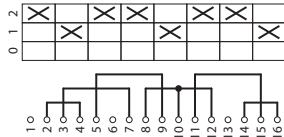
## Without emergency switch off/emergency stop function

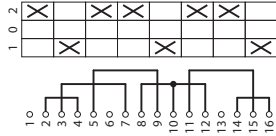
Front plate	Contact sequence	Number of poles N/O	Rated current	Part number	Article number	Pack qty	Suitable for export to North America (US and Canada)	Padlockable handle
<b>2 speed, non reversing, for 2 separate windings</b>								
 FS 644		6	20 A	T0-3-8451/EZ	083936	1	✓	X
			32 A	T3-3-8451/EZ	000956	1	✓	X
<b>2 speed, 2 directions, for one tapped winding</b>								
 FS 644		3	20 A	T0-4-8440/EZ	088682	1	✓	X
			32 A	T3-4-8440/EZ	000959	1	✓	X
 FS 684		3	20 A	T0-4-8441/EZ	093428	1	✓	X







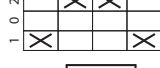
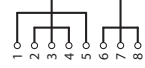
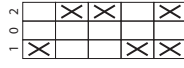
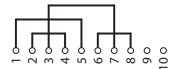

000956

Photo is representative

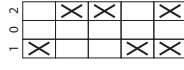
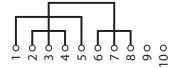
# Centre mounting - Reversing switch-disconnectors

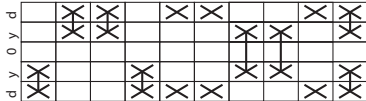
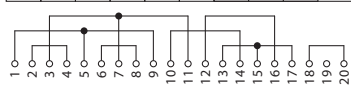
## Without emergency switch off/emergency stop function

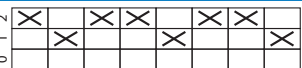
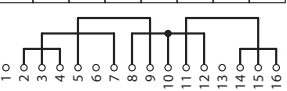
Front plate	Contact sequence	Number of poles N/O	Rated current	Part number	Article number	Pack qty	Suitable for export to North America (US and Canada)	Padlockable handle
<b>Reversing switch, without Automatic (spring) return to 0 (Off) position</b>								
 FS 684	 	2	20 A	T0-2-8400/EZ	055452	1	✓	X
			32 A	T3-2-8400/EZ	000687	1	✓	X
	 	3	20 A	T0-3-8401/EZ	093420	1	✓	X
			32 A	T3-3-8401/EZ	000694	1	✓	X
<b>Reversing switch, with Automatic (spring) return from both directions to 0 (Off) position</b>								
 FS 4011	 	3	20 A	T0-3-8228/EZ	048334	1	✓	X
			32 A	T3-3-8228/EZ	000695	1	✓	X
<b>Reversing star delta switch, two-way operating direction</b>								
 FS 638	 	3	20 A	T0-5-15876/EZ	000900	1	✓	X
			32 A	T3-5-15876/EZ	000797	1	✓	X
<b>Reversing multi speed switch 2 speed, 2 directions, for one tapped winding</b>								
 FS 629	 		20 A	T0-6-15866/EZ	012747	1	✓	X



000694



012747

Photos are representative

# Centre mounting - Reversing star delta switch-disconnectors

## Without emergency switch off/emergency stop function

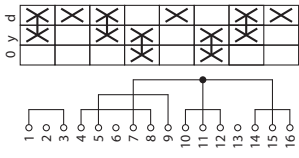
Front plate	Contact sequence	Number of poles N/O	Rated current	Part number	Article number	Pack qty	Suitable for export to North America (US and Canada)	Padlockable handle
 FS 635		3	20 A	T0-4-8410/EZ	053080	1	✓	X
			32 A	T3-4-8410/EZ	000721	1	✓	X

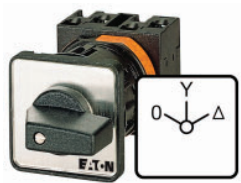







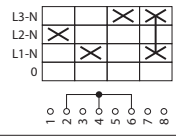

000721

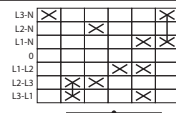
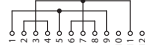
Photo is representative

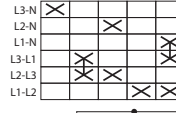
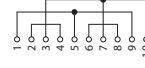
# Centre mounting - Selector switch-disconnectors

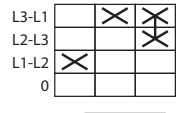
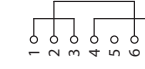
## Without emergency switch off/emergency stop function

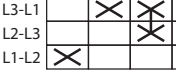
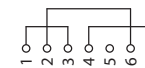
Front plate	Contact sequence	Number of poles	Rated current	Part number	Article number	Pack qty	Suitable for export to North America (US and Canada)	Padlockable handle
<b>Voltmeter</b>								
		3 x phase-N with 0 position	20 A	T0-2-15921/EZ	069710	1	✓	X
FS 1410757								
		3 x phase-phase 3 x phase-N with 0 position	20 A	T0-3-8007/EZ	098186	1	✓	X
FS 1410759								
		3 x phase-phase 3 x phase-N without 0 position with complete rotation in both directions	20 A	T0-3-15924/EZ	022251	1	✓	X
FS 164721								
		3 x phase-phase with 0 position	20 A	T0-2-15920/EZ	041234	1	✓	X
FS 1410755								
		3 x phase-phase without 0 position	20 A	T0-2-15922/EZ	055472	1	✓	X
FS 164854								













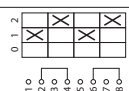
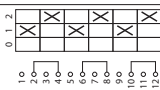

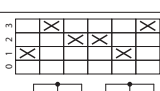
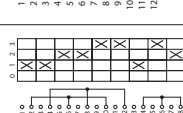
098186

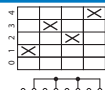
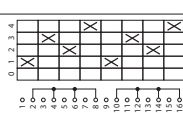
Photo is representative

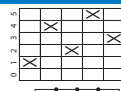
# Centre mounting - Step switch-disconnectors

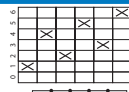
## Without emergency switch off/emergency stop function

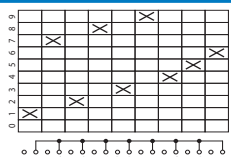
Front plate	Contact sequence	Rated current	Number of poles N/O	Part number	Article number	Pack qty	Suitable for export to North America (US and Canada)	Padlockable handle
<b>2 steps 60°</b>								
 F 075		10 A	1	TM-1-8240/EZ	015226	1	✓	X
		10 A	2	TM-2-8260/EZ	045483	1	✓	X
		10 A	3	TM-3-8280/EZ	045496	1	✓	X
<b>3 steps 45°</b>								
 F 109		10 A	1	TM-2-8241/EZ	015256	1	✓	X
		10 A	2	TM-3-8261/EZ	000698	1	✓	X
		10 A	3	TM-5-8281/EZ	046125	1	✓	X
<b>4 steps 30°</b>								
 F 002		10 A	1	TM-3-8242/EZ	015506	1	✓	X
		10 A	2	TM-4-8262/EZ	046120	1	✓	X
<b>5 steps 30°</b>								
 F 003		10 A	1	TM-3-8243/EZ	015537	1	✓	X
<b>6 steps 30°</b>								
 F 004		10 A	1	TM-3-8244/EZ	045495	1	✓	X
<b>9 steps 30°</b>								
 F 007		10 A	1	TM-5-8247/EZ	015565	1	✓	X











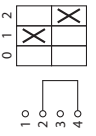

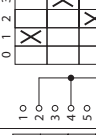

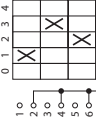

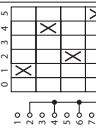
015537

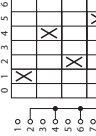
Photo is representative

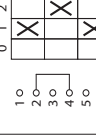
# Centre mounting - Step switch-disconnectors

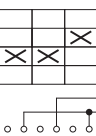
## Without emergency switch off/emergency stop function

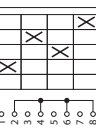
Front plate	Contact sequence	Number of poles N/O	Rated current	Part number	Article number	Pack qty	Suitable for export to North America (US and Canada)	Padlockable handle
With O (Off) position								
 FS 418		1	20 A	T0-1-8240/EZ	043597	1	✓	X
 FS 420		1	20 A	T0-2-8241/EZ	053089	1	✓	X
 FS 422		1	20 A	T0-2-8242/EZ	069700	1	✓	X
 FS 424		1	20 A	T0-3-8243/EZ	083938	1	✓	X
 FS 426		1	20 A	T0-3-8244/EZ	098176	1	✓	X
 FS 418		3	20 A	T0-3-8280/EZ	036479	1	✓	X
 FS 420		3	20 A	T0-5-8281/EZ	050717	1	✓	X
 FS 422		3	20 A	T0-6-8282/EZ	064955	1	✓	X













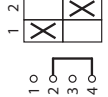

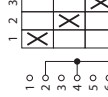

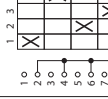

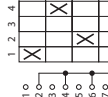
043597

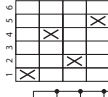
Photo is representative

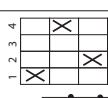

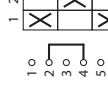
# Centre mounting - Step switch-disconnectors

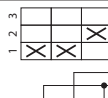
## Without emergency switch off/emergency stop function

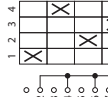
Front plate	Contact sequence	Number of poles N/O	Rated current	Part number	Article number	Pack qty	Suitable for export to North America (US and Canada)	Padlockable handle
Without 0 (Off) position								
 FS 943		1	20 A	T0-1-8220/EZ	<a href="#">095799</a>	1	✓	X
 FS 404		1	20 A	T0-2-8230/EZ	<a href="#">091058</a>	1	✓	X
 FS 606		1	20 A	T0-2-8231/EZ	<a href="#">015123</a>	1	✓	X
 FS 408		1	20 A	T0-3-8232/EZ	<a href="#">029361</a>	1	✓	X
 FS 410		1	20 A	T0-3-8233/EZ	<a href="#">043599</a>	1	✓	X
 FS 406		2	20 A	T0-3-8251/EZ	<a href="#">013972</a>	1	✓	X
 FS 943		3	20 A	T0-3-8222/EZ	<a href="#">015118</a>	1	✓	X
 FS 404		3	20 A	T0-5-8270/EZ	<a href="#">093432</a>	1	✓	X
 FS 406		3	20 A	T0-6-8271/EZ	<a href="#">017497</a>	1	✓	X









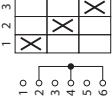
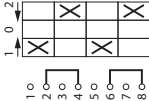

017497

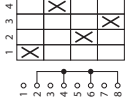
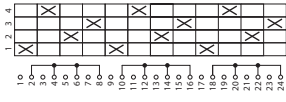
Photo is representative

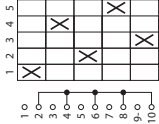
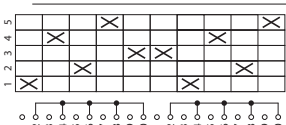
# Centre mounting - Step switch-disconnectors

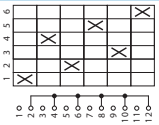
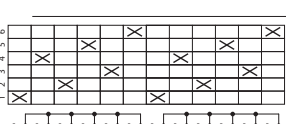
## Without emergency switch off/emergency stop function

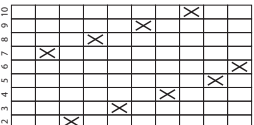
Front plate	Contact sequence	Number of poles	Rated current	Part number	Article number	Pack qty	Suitable for export to North America (US and Canada)	Padlockable handle
<b>3 steps 60°</b>								
 F 076		1	10 A	TM-2-8230/EZ	000701	1	✓	X
		3	10 A	TM-5-8270/EZ	046124	1	✓	X
<b>4 steps, 60°</b>								
 F 077		1	10 A	TM-2-8231/EZ	000700	1	✓	X
		3	10 A	TM-6-8271/EZ	046128	1	✓	X
<b>5 steps 60°</b>								
 F 078		1	10 A	TM-3-8232/EZ	015592	1	✓	X
		2	10 A	TM-5-8252/EZ	046123	1	✓	X
<b>6 steps 60°, no full rotation</b>								
 F 079		1	10 A	TM-3-8233/EZ	015630	1	✓	X
		2	10 A	TM-6-8253/E	046127	1	✓	X
<b>10 steps 30°</b>								
 F 011		1	10 A	TM-5-8237/EZ	015661	1	✓	X



015630

Photo is representative

# Centre mounting - Step switch-disconnectors for heating

## Without emergency switch off/emergency stop function

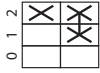
Front plate	Contact sequence	Rated current	Number of poles N/O	Part number	Article number	Pack qty	Suitable for export to North America (US and Canada)	Padlockable handle
With 0 (OFF) position								
		20 A	1	T0-1-91/EZ	074455	1	✓	X
FS 614	1 0 2 0 0 0 2 0 3 0 4							



074455

## Centre mounting dedicated accessories

### Key operated lock mechanism

For ordering with base switch unit		For ordering as a standalone unit		Key withdrawable in position
Part number	Article number	Part number	Article number	
<b>Micromec lock 90° switch angle</b>				
+EZ/S-A	045458	EZ/S-A-TM	046991	0°
+EZ/S-B	045459	EZ/S-B-TM	046992	270°
+EZ/S-E	045462	EZ/S-E-TM	046995	0° + 90°
+EZ/S-F	045463	EZ/S-F-TM	046996	270° & 0°
+EZ/S-G	045464	EZ/S-G-TM	046997	270° + 0° + 90° + 180°
+EZ/S-R	045471	EZ/S-R-TM	047004	270° + 0° + 90°
<b>Ronis lock 60° switch angle</b>				
+EZ/S-D	045461	X	X	270° + 90°
+EZ/S-H	045465	X	X	300° + 0° + 60° + 120° + 180° + 240°
+EZ/S-J	045466	X	X	270° + 330° + 30° + 90° + 150° + 210°
+EZ/S-N	045468	X	X	270° + 330° + 90° + 150°



Key operation lock mechanism, including. 2 keys.

The key can only be removed in certain positions; see diagram. The MICROMECC lock for 90° can be used for other switching angles as well if the key withdrawability characteristics match the type of switch.

Example: +EZ/S-B can be used with a step switch with a switching angle of 30° if the key is only to be withdrawable in the 0 position at 270°.

#### Options for key withdrawal

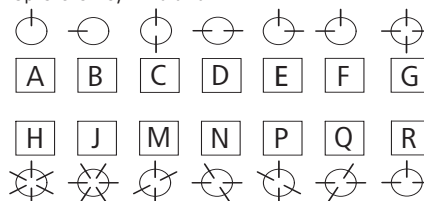

#### Position marking as in example

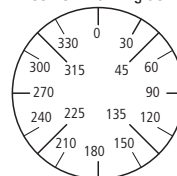

Photos are representative

# Rear mounting switch-disconnectors

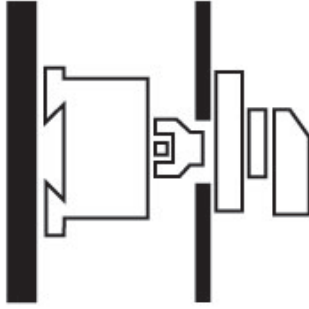

## Description

Rear mounting switch-disconnectors can be easily installed, either using screw fixings or directly onto a DIN-Rail, on the rear of a panel, control board, enclosures in machinery, switchboard and switchgear.

## Standards/Approvals

See details page 178

## Technical data

- Voltage: 690 V a.c.
- Current: 20 A to 315 A
- Mounting method: Screw fixings or directly onto a DIN-Rail

## Features

- Available with or without emergency switching off/emergency stop function
- Available with and without auxiliary contacts
- Available with red rotary handle and yellow locking collar and black rotary handle and locking collar
- 1-pole to 8-pole options
- 



T3 Rear mounting



P1 Rear mounting

Photos are representative

## Rear mounting - Range overview

Rated current	20 A	25 A	32 A	40 A	63 A	100 A	125 A	160 A	250 A	275 A	315 A				
<b>On-Off switch-disconnectors</b>	<b>T0</b>	<b>P1</b>	<b>P1</b>	<b>T3</b>	<b>P1</b>	<b>P3</b>	<b>T5B</b>	<b>P3</b>	<b>T5</b>	<b>P5</b>	<b>P5</b>	<b>T6</b>	<b>P5</b>		<b>P5</b>
Without auxiliary contacts	✓	✓	✓	✓	✓	✓	✓	✓		✓	✓		✓		✓
With auxiliary contacts	✓			✓			✓		✓						
<b>Main switch-disconnectors</b>	<b>T0</b>	<b>P1</b>	<b>P1</b>	<b>T3</b>	<b>P1</b>	<b>P3</b>	<b>T5B</b>	<b>P3</b>	<b>T5</b>	<b>P5</b>	<b>P5</b>	<b>T6</b>	<b>P5</b>	<b>T8</b>	<b>P5</b>
Without auxiliary contacts	✓	✓	✓	✓	✓	✓	✓	✓	✓	✓	✓		✓		✓
With auxiliary contacts	✓	✓	✓	✓	✓	✓	✓	✓	✓	✓	✓	✓	✓	✓	✓
<b>Main switch-disconnectors with 400 mm metal shaft extension</b>		<b>P1</b>	<b>P1</b>	<b>T3</b>	<b>P1</b>	<b>P3</b>		<b>P3</b>							
Without auxiliary contacts		✓	✓		✓	✓		✓							
With auxiliary contacts		✓	✓		✓	✓		✓							
<b>Changeover switch-disconnectors</b>	<b>T0</b>			<b>T3</b>			<b>T5B</b>		<b>T5</b>						
Without auxiliary contacts	✓			✓			✓		✓						
<b>Manual/auto switch-disconnectors</b>	<b>T0</b>														
Without auxiliary contacts	✓														
<b>Multi speed switch-disconnectors</b>	<b>T0</b>			<b>T3</b>			<b>T5B</b>								
Without auxiliary contacts	✓			✓			✓								
<b>Reversing speed switch-disconnectors</b>	<b>T0</b>			<b>T3</b>			<b>T5B</b>								
Without auxiliary contacts	✓			✓			✓								
<b>Selector switch-disconnectors</b>	<b>T0</b>														
Without auxiliary contacts	✓														
<b>Star-delta switch-disconnectors</b>	<b>T0</b>			<b>T3</b>			<b>T5B</b>								
Without auxiliary contacts	✓			✓			✓								
<b>Step switch-disconnectors</b>	<b>T0</b>														
Without auxiliary contacts	✓														
<b>Universal switch-disconnectors</b>	<b>T0</b>														
Without auxiliary contacts	✓														

# Rear mounting - On-Off switch-disconnectors without auxiliary contacts

## Without emergency switch off/emergency stop function

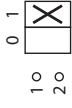
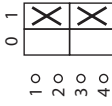
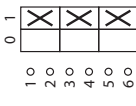
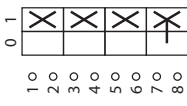
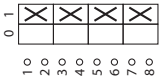
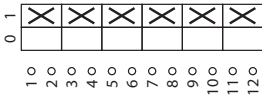
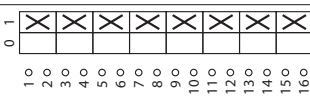
Front plate	Contact sequence	Number of poles	Rated current	Part number	Article number	Pack qty	Suitable for export to North America (US and Canada)	Padlockable handle		
 FS 908	 1 0 1 0 2 0	1	20 A	T0-1-8200/Z	076844	1	✓	X		
			20 A	T0-1-15401/Z	048346	1	✓	X		
			32 A	T3-1-8200/Z	071327	1	✓	X		
			63 A	T5B-1-8200/Z	094270	1	✓	X		
	 1 0 1 0 2 0 3 0 4 0	2	20 A	T0-1-102/Z	095828	1	✓	X		
			20 A	T0-1-15402/Z	062584	1	✓	X		
			32 A	T3-1-102/Z	083192	1	✓	X		
			63 A	T5B-1-102/Z	094460	1	✓	X		
			 1 0 1 0 2 0 3 0 4 0 5 0 6 0	3	20 A	T0-2-1/Z	036504	1	✓	X
					20 A	T0-2-15403/Z	076822	1	✓	X
	25 A	P1-25/Z			057708	1	✓	X		
	32 A	P1-32/Z			098049	1	✓	X		
40 A	P1-40/Z	199964			1	X	X			
63 A	P3-63/Z	050591			1	✓	X			
100 A	P3-100/Z	280920			1	✓	X			
125 A	P5-125/Z	090931			1	✓	X			
160 A	P5-160/Z	280934			1	✓	X			
250 A	P5-250/Z	280948			1	✓	X			
 1 0 1 0 2 0 3 0 4 0 5 0 6 0 7 0 8 0	3 + N	20 A	T0-2-8900/Z	207407	1	✓	X			
		25 A	P1-25/Z/N	088710	1	✓	X			
		32 A	P1-32/Z/N	015148	1	✓	X			
		40 A	P1-40/Z/N	199966	1	X	X			
		63 A	P3-63/Z/N	027013	1	✓	X			
		100 A	P3-100/Z/N	038878	1	✓	X			
		 1 0 1 0 2 0 3 0 4 0 5 0 6 0 7 0 8 0	4	20 A	T0-2-15404/Z	091060		✓	X	
				 1 0 1 0 2 0 3 0 4 0 5 0 6 0 7 0 8 0 9 0 10 0 11 0 12 0	6	20 A	T0-3-8342/Z	055489	1	✓
32 A	T3-3-8342/Z	052344	1			✓	X			
63 A	T5B-3-8342/Z	092297	1			✓	X			
 1 0 1 0 2 0 3 0 4 0 5 0 6 0 7 0 8 0 9 0 10 0 11 0 12 0 13 0 14 0 15 0 16 0	8	20 A	T0-4-8344/Z			014009	1	✓	X	
		32 A	T3-4-8344/Z			020600	1	✓	X	















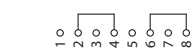
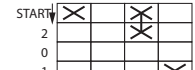
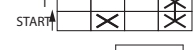
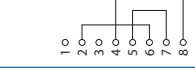



015148

Photo is representative

# Rear mounting - On-Off switch-disconnectors without auxiliary contacts

## Without emergency switch off/emergency stop function



Front plate	Contact sequence	Number of poles N/O	Rated current	Part number	Article number	Pack qty	Suitable for export to North America (US and Canada)	Padlockable handle
<b>ON - OFF Switch - With Automatic (spring) return in START position</b>								
		1	20 A	T0-1-15511/Z	029367	1	✓	X
FS 147767								
		2	20 A	T0-2-15512/Z	043605	1	✓	X
								
		2	20 A	T0-2-8177/Z	024622	1	✓	X
								
								
								
<b>ON-OFF Panic switch - Key can only be withdrawn in position 0 (Pos A)</b>								
		3	20 A	T0-2-1/Z/SVA(A)	050978	1	✓	✓
FS 908								
		3	25 A	P1-25/Z/SVA(A)	050969	1	✓	✓
								
<b>ON-OFF Panic switch - Key operation lock mechanism ST-0 Key can only be withdrawn in position 0 (Pos A)</b>								
		2	20 A	T0-1-102/Z/S	014971	1	✓	X
FS 908								
<b>ON Switch - With Automatic (spring) return from position 1</b>								
		1	20 A	T0-1-15321/Z	095809	1	✓	X
FS 4721								



Photos are representative

# Rear mounting - On-Off switch-disconnectors with auxiliary contacts

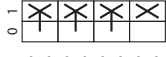
## Without emergency switch off/emergency stop function

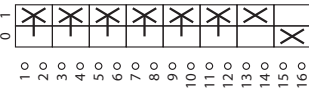
Front plate	Contact sequence	Number of poles			Auxiliary contacts			Rated current	Part number	Article number	Pack qty	Suitable for export to North America (US and Canada)	Padlockable handle
		N/O	N/O	N/C	N/O	N/O	N/C						
 FS 908	 1 2 3 4 5 6 7 8	3	1	0	20 A	T0-2-15679/Z	<a href="#">041252</a>	1	✓	X			
	 0 0 0 0 0 0 0 0 0 0 0 0 1 2 3 4 5 6 7 8 9 10 11 12	3-N	1	1	32 A	T3-3-8901/Z	<a href="#">231952</a>	1	✓	X			
	 1 2 3 4 5 6 7 8 9 10 11 12 13 14 15 16	6	1	1	20 A	T0-4-15682/Z	<a href="#">022270</a>	1	✓	X			
					32 A	T3-4-15682/Z	<a href="#">030988</a>	1	✓	X			
					63 A	T5B-4-15682/Z	<a href="#">207429</a>	1	✓	X			
					100 A	T5-4-15682/Z	<a href="#">207417</a>	1	✓	X			









231952

Photo is representative

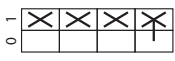
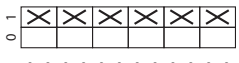

# Rear mounting - Main switch-disconnectors without auxiliary contacts

## Without emergency switch off/emergency stop function

Front plate	Contact sequence	Number of poles N/O	Rated current	Part number	Article number	Pack qty	Suitable for export to North America (US) and Canada	Padlockable handle
FS 908 		1	20 A	T0-1-8200/V/SVB-SW	060229	1	✓	✓
			32 A	T3-1-8200/V/SVB-SW	004882	1	✓	✓
		2	20 A	T0-1-102/V/SVB-SW	022330	1	✓	✓
			32 A	T3-1-102/V/SVB-SW	021493	1	✓	✓
			63 A	T5B-1-102/V/SVB-SW	094462	1	✓	✓
			20 A	T0-2-1/V/SVB-SW	045992	1	✓	✓
			25 A	P1-25/V/SVB-SW	050738	1	✓	✓
			30 A	P3-30/V/SVB-SW-MCS	237895	1	✓	✓
		3	32 A	P1-32/V/SVB-SW	055484	1	✓	✓
			40 A	P1-40/V/SVB-SW	199958	1	X	✓
			63 A	P3-63/V/SVB-SW	060230	1	✓	✓
			100 A	P3-100/V/SVB-SW	064976	1	✓	✓
			125 A	P5-125/V/SVB-SW	280917	1	✓	✓
			160 A	P5-160/V/SVB-SW	280931	1	✓	✓
			250 A	P5-250/V/SVB-SW	280945	1	✓	✓
			315 A	P5-315/V/SVB-SW	280959	1	✓	✓
			20 A	T0-2-8900/V/SVB-SW	207406	1	✓	✓
			25 A	P1-25/V/SVB-SW/N	088706	1	✓	✓
		3 + N	32 A	P1-32/V/SVB-SW/N	098198	1	✓	✓
			40 A	P1-40/V/SVB-SW/N	199961	1	X	✓
			63 A	P3-63/V/SVB-SW/N	017517	1	✓	✓
			100 A	P3-100/V/SVB-SW/N	027009	1	✓	✓
			125 A	P5-125/V/SVB-SW/N	280919	1	✓	✓
			160 A	P5-160/V/SVB-SW/N	280933	1	✓	✓
			250 A	P5-250/V/SVB-SW/N	280947	1	✓	✓
			315 A	P5-315/V/SVB-SW/N	280961	1	✓	✓
		6	20 A	T0-3-8342/V/SVB-SW	036501	1	✓	✓
			32 A	T3-3-8342/V/SVB-SW	078445	1	✓	✓
			63 A	T5B-3-8342/V/SVB-SW	092299	1	✓	✓
			100 A	T5-3-8342/V/SVB-SW	096380	1	X	✓
			20 A	T0-4-8344/V/SVB-SW	008272	1	✓	✓
		8	32 A	T3-4-8344/V/SVB-SW	008967	1	✓	✓
			63 A	T5B-4-8344/V/SVB-SW	092055	1	✓	✓
			100 A	T5-4-8344/V/SVB-SW	095958	1	X	✓













021493

Photo is representative

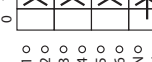
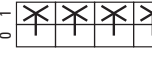
# Rear mounting - Main switch-disconnectors without auxiliary contacts

## With emergency switch off/emergency stop function

Front plate	Contact sequence	Number of poles N/O	Rated current	Part number	Article number	Pack qty	Suitable for export to North America (US) and Canada	Padlockable handle
 FS 908	 1 0 1 0	1	20 A	T0-1-8200/V/SVB	<a href="#">057856</a>	1	✓	✓
			32 A	T3-1-8200/V/SVB	<a href="#">007255</a>	1	✓	✓
			63 A	T5B-1-8200/V/SVB	<a href="#">094273</a>	1	✓	✓
	 1 0 1 0 2 0 1 0 2 0 4 0	2	20 A	T0-1-102/V/SVB	<a href="#">095824</a>	1	✓	✓
			32 A	T3-1-102/V/SVB	<a href="#">019120</a>	1	✓	✓
			63 A	T5B-1-102/V/SVB	<a href="#">094463</a>	1	✓	✓
	 1 0 1 0 2 0 4 0 1 0 2 0 4 0 6 0	3	20 A	T0-2-1/V/SVB	<a href="#">043619</a>	1	✓	✓
			25 A	P1-25/V/SVB	<a href="#">055335</a>	1	✓	✓
			30 A	P3-30/V/SVB-MCS	<a href="#">237894</a>	1	✓	✓
			32 A	P1-32/V/SVB	<a href="#">095676</a>	1	✓	✓
			40 A	P1-40/V/SVB	<a href="#">199952</a>	1	X	✓
			63 A	P3-63/V/SVB	<a href="#">048218</a>	1	✓	✓
 1 0 1 1 1 0 1 1 1 0 1 1 2 0 1 1 2 0 1 1 3 0 1 1 3 0	3	100 A	P3-100/V/SVB	<a href="#">088558</a>	1	✓	✓	
		125 A	P5-125/V/SVB	<a href="#">280914</a>	1	✓	✓	
		160 A	P5-160/V/SVB	<a href="#">280928</a>	1	✓	✓	
		250 A	P5-250/V/SVB	<a href="#">280942</a>	1	✓	✓	
		315 A	P5-315 kW/V/SVB	<a href="#">280956</a>	1	✓	✓	
 1 0 1 0 2 0 4 0 6 0 7 0 8 0	3 + N	20 A	T0-2-8900/V/SVB	<a href="#">207405</a>	1	✓	✓	
		 1 0 1 0 2 0 4 0 6 0 8 0 N 0	25 A	P1-25/V/SVB/N	<a href="#">086333</a>	1	✓	✓
			32 A	P1-32/V/SVB/N	<a href="#">095825</a>	1	✓	✓
			40 A	P1-40/V/SVB/N	<a href="#">199955</a>	1	X	✓
			63 A	P3-63/V/SVB/N	<a href="#">015144</a>	1	✓	✓
		 1 0 1 1 1 0 1 1 1 0 1 1 2 0 1 1 2 0 1 1 3 0 1 1 3 0 2 1 1 0 2 1 1 0	100 A	P3-100/V/SVB/N	<a href="#">024636</a>	1	✓	✓
			125 A	P5-125/V/SVB/N	<a href="#">280916</a>	1	✓	✓
		 1 0 1 1 1 0 1 1 1 0 1 1 2 0 1 1 2 0 1 1 3 0 1 1 3 0 2 1 1 0 2 1 1 0	160 A	P5-160/V/SVB/N	<a href="#">280930</a>	1	✓	✓
			250 A	P5-250/V/SVB/N	<a href="#">280944</a>	1	✓	✓
			315	P5-315 kW/V/SVB/N	<a href="#">280958</a>	1	✓	✓
 1 0 1 0 2 0 4 0 6 0 8 0 10 0 11 0 12 0	6	20 A	T0-3-8342/V/SVB	<a href="#">034128</a>	1	✓	✓	
		32 A	T3-3-8342/V/SVB	<a href="#">076072</a>	1	✓	✓	
		63 A	T5B-3-8342/V/SVB	<a href="#">092300</a>	1	✓	✓	
		100 A	T5-3-8342/V/SVB	<a href="#">096381</a>	1	X	✓	
 1 0 1 0 2 0 4 0 6 0 8 0 10 0 11 0 12 0 13 0 14 0 15 0 16 0	8	20 A	T0-4-8344/V/SVB	<a href="#">014007</a>	1	✓	✓	
		32 A	T3-4-8344/V/SVB	<a href="#">020598</a>	1	✓	✓	
		63 A	T5B-4-8344/V/SVB	<a href="#">092056</a>	1	✓	✓	
		100 A	T5-4-8344/V/SVB	<a href="#">095959</a>	1	X	✓	













280958

Photo is representative

# Rear mounting - Main switch-disconnectors with auxiliary contacts

## Without emergency switch off/emergency stop function

Front plate	Contact sequence	Number of poles N/O	Auxiliary contacts N/O N/C	Rated current	Part number	Article number	Pack qty	Suitable for export to North America (US) and Canada	Padlockable handle
 FS 908	 1 0 1 2 3 4 5 6 7 8	3	1 0	20 A	T0-2-15679/V/SVB-SW	088707	1	✓	✓
	 1 0 1 2 3 4 5 6 7 8 13 14 21 22	3	1 1	25 A 32 A 40 A 63 A 100 A	P1-25/V/SVB-SW/HI11 P1-32/V/SVB-SW/HI11 P1-40/V/SVB-SW/HI11 P3-63/V/SVB-SW/HI11 P3-100/V/SVB-SW/HI11	098199 017518 199959 027010 036502	1	✓ ✓ X ✓ ✓	✓ ✓ ✓ ✓ ✓
	 1 0 11 12 13 14 7 8	3	1 0	125 A 160 A 250 A 315 A	P5-125/V/SVB-SW/HI10 P5-160/V/SVB-SW/HI10 P5-250/V/SVB-SW/HI10 P5-315/V/SVB-SW/HI10	280918 280932 280946 280960	1	✓ ✓ ✓ ✓	✓ ✓ ✓ ✓
	 1 0 1 2 3 4 5 6 7 8 9 10 11 12	3	2 1	20 A	T0-3-15683/V/SVB-SW	015664	1	✓	✓
	 1 0 1 2 3 4 5 6 7 8 9 10 11 12	3 + N	1 1	20 A 32 A	T0-3-15680/V/SVB-SW T3-3-15680/V/SVB-SW	045994 019121	1	✓ ✓	✓ ✓
	 1 0 1 2 3 4 5 6 7 8 9 10 11 12 13 14 21 22	3 + N	1 1	32 A 40 A	P1-32/V/SVB-SW/N/HI11 P1-40/V/SVB-SW/N/HI11	064978 199962	1	✓ X	✓ ✓
	 1 0 1 2 3 4 5 6 7 8 9 10 11 12	3 + N	1 1	32 A 63 A	P1-25/V/SVB-SW/N/HI11 T5B-3-8901/V/SVB-SW	055486 207423	1	✓ ✓	✓ ✓
	 1 0 1 2 3 4 5 6 7 8 9 10 11 12 13 14 21 22	3 + N	1 1	63 A 100 A	P3-63/V/SVB-SW/N/HI11 P3-100/V/SVB-SW/N/HI11	074470 083962	1	✓ ✓	✓ ✓
	 1 0 1 2 3 4 5 6 7 8 9 10 11 12 13 14 15 16	6	1 1	20 A 32 A 63 A 100 A	T0-4-15682/V/SVB-SW T3-4-15682/V/SVB-SW T5B-4-15682/V/SVB-SW T5-4-15682/V/SVB-SW	027011 061835 207428 207416	1	✓ ✓ ✓ X	✓ ✓ ✓ ✓
	 1 0 11 12 13 14 21 22 2L1 2L2 2L3 2T1 2T2 2T3 13 14 21 22	6	1 1	160 A	T6-160-15682/V/SVB-SW/HI11	200127	1	X	✓
 1 0 11 12 13 14 21 22 2L1 2L2 2L3 2T1 2T2 2T3 103 104 101 102	6	1 1	275 A	T8-3-8342/V/SVB-SW/HI11	200128	1	X	✓	



199959

Photo is representative

# Rear mounting - Main switch-disconnectors with auxiliary contacts

## With emergency switch off/emergency stop function

Front plate	Contact sequence	Number of poles			Auxiliary contacts			Rated current	Part number	Article number	Pack qty	Suitable for export to North America (US) and Canada	Padlockable handle
		N/O	N/O	N/C	N/O	N/O	N/C						
FS 908		3	1	0	20 A	T0-2-15679/V/SVB	086334	1	✓	✓			
	25 A	P1-25/V/SVB/HI11	095826	1	✓	✓							
	32 A	P1-32/V/SVB/HI11	015145	1	✓	✓							
	40 A	P1-40/V/SVB/HI11	199953	1	X	✓							
	63 A	P3-63/V/SVB/HI11	024637	1	✓	✓							
	100 A	P3-100/V/SVB/HI11	034129	1	✓	✓							
	125 A	P5-125/V/SVB/HI10	280915	1	✓	✓							
	160 A	P5-160/V/SVB/HI10	280929	1	✓	✓							
	250 A	P5-250/V/SVB/HI10	280943	1	✓	✓							
	315 A	P5-315/V/SVB/HI10	280957	1	✓	✓							
		20 A	T0-3-15683/V/SVB	015634	1	✓	✓						
32 A		T3-3-15683/V/SVB	045224	1	✓	✓							
	20 A	T0-3-15680/V/SVB	043621	1	✓	✓							
	32 A	P1-25/V/SVB/N/HI11	053113	1	✓	✓							
	32 A	T3-3-15680/V/SVB	016748	✓	✓								
	32 A	P1-32/V/SVB/N/HI11	062605	1	✓	✓							
	40 A	P1-40/V/SVB/N/HI11	199956	1	X	✓							
	63 A	T5B-3-8901/V/SVB	207422	1	✓	✓							
		63 A	P3-63/V/SVB/N/HI11	072097	1	✓	✓						
100 A		P3-100/V/SVB/N/HI11	081589	1	✓	✓							
	20 A	T0-4-15682/V/SVB	024638	1	✓	✓							
	32 A	T3-4-15682/V/SVB	059462	1	✓	✓							
	63 A	T5B-4-15682/V/SVB	207427	1	✓	✓							
	100 A	T5-4-15682/V/SVB	207415	1	X	✓							
	160 A	T6-160-15682/V/SVB/HI11	200619	1	X	✓							
	275 A	T8-3-8342/V/SVB/HI11	200620	1	X	✓							



199956

Photo is representative

# Rear mounting - Main switch-disconnectors with 400 mm metal extension shaft without auxiliary contacts

## Without emergency switch off/emergency stop function

Front plate	Handle type	Contact sequence	Number of poles N/O	Rated current	Part number	Article number	Pack qty	Suitable for export to North America (US) and Canada	Padlockable handle	
 FS 908	Padlockable main switch handle		3	25 A	P1-25/M4/SVB-SW	<a href="#">172876</a>	1	✓	✓	
			3	32 A	P1-32/M4/SVB-SW	<a href="#">172866</a>	1	✓	✓	
			3	40 A	P1-40/M4/SVB-SW	<a href="#">199940</a>	1	✓	✓	
			3	63 A	P3-63/M4/SVB-SW	<a href="#">172785</a>	1	✓	✓	
			3	100 A	P3-100/M4/SVB-SW	<a href="#">172819</a>	1	✓	✓	
			3 + N	32 A	P1-32/M4/SVB-SW/N	<a href="#">172868</a>	1	✓	✓	
	K-Line K1 Knob		3	25 A	P1-25/M4/K1-PG	<a href="#">172772</a>	1	✓	✓	
			3	32 A	P1-32/M4/K1-PG	<a href="#">172874</a>	1	✓	✓	
			3 + N	25 A	P1-25/M4/K1-PG/N	<a href="#">172774</a>	1	✓	✓	
			3 + N	32 A	P1-32/M4/K1-PG/N	<a href="#">172779</a>	1	✓	✓	
		K-Line K2 Knob		3	63 A	P3-63/M4/K2-PG	<a href="#">172811</a>	1	✓	✓
				3	100 A	P3-100/M4/K2-PG	<a href="#">172827</a>	1	✓	✓
	3 + N		63 A	P3-63/M4/K2-PG/N	<a href="#">172813</a>	1	✓	✓		
	3 + N		100 A	P3-100/M4/K2-PG/N	<a href="#">172829</a>	1	✓	✓		









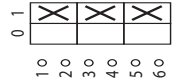

172772

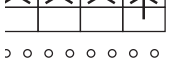
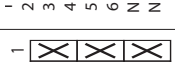
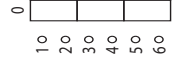
Photo is representative

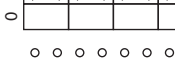
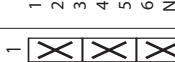
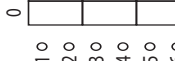
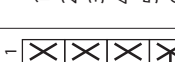
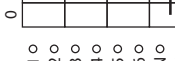
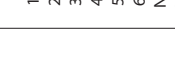
# Rear mounting - Main switch-disconnectors with 400 mm metal extension shaft without auxiliary contacts

## With emergency switch off/emergency stop function

Front plate	Handle type	Contact sequence	Number of poles N/O	Rated current	Part number	Article number	Pack qty	Suitable for export to North America (US) and Canada	Padlockable handle		
 FS 908	Padlockable main switch handle		3	25 A	P1-25/M4/SVB	<a href="#">172875</a>	1	✓	✓		
			3	32 A	P1-32/M4/SVB	<a href="#">172865</a>	1	✓	✓		
			3	40 A	P1-40/M4/SVB	<a href="#">199936</a>	1	✓	✓		
			3	63 A	P3-63/M4/SVB	<a href="#">172784</a>	1	✓	✓		
			3	100 A	P3-100/M4/SVB	<a href="#">172818</a>	1	✓	✓		
			3 + N	25 A	P1-25/M4/SVB/N	<a href="#">172877</a>	1	✓	✓		
			3 + N	32 A	P1-32/M4/SVB/N	<a href="#">172867</a>	1	✓	✓		
			3 + N	40 A	P1-40/M4/SVB/N	<a href="#">199938</a>	1	✓	✓		
		K-Line K1 Knob		3	25 A	P1-25/M4/K1-PR	<a href="#">172771</a>	1	✓	✓	
				3	32 A	P1-32/M4/K1-PR	<a href="#">172873</a>	1	✓	✓	
				3 + N	25 A	P1-25/M4/K1-PR/N	<a href="#">172773</a>	1	✓	✓	
				3 + N	32 A	P1-32/M4/K1-PR/N	<a href="#">172778</a>	1	✓	✓	
			K-Line K2 Knob		3	63 A	P3-63/M4/K2-PR	<a href="#">172810</a>	1	✓	✓
					3	100 A	P3-100/M4/K2-PR	<a href="#">172826</a>	1	✓	✓
				3 + N	63 A	P3-63/M4/K2-PR/N	<a href="#">172812</a>	1	✓	✓	
	3 + N	100 A		P3-100/M4/K2-PR/N	<a href="#">172828</a>	1	✓	✓			



172875

Photo is representative

# Rear mounting - Main switch-disconnectors with 400 mm metal extension shaft with auxiliary contacts

## Without emergency switch off/emergency stop function

Front plate	Handle type	Contact sequence	Number of poles			Auxiliary contact			Rated current	Part number	Article number	Pack qty	Suitable for export to North America (US) and Canada
			N/O	N/O	N/C	N/O	N/O	N/C					
FS 908	Padlockable main switch handle		3	1	1	25 A	P1-25/M4/SVB-SW/HI11	172768	1	✓			
			3	1	1	32 A	P1-32/M4/SVB-SW/HI11	172870	1	✓			
			3	1	1	40 A	P1-40/M4/SVB-SW/HI11	199941	1	✓			
			3	1	1	63 A	P3-63/M4/SVB-SW/HI11	172807	1	✓			
			3+N	1	1	25 A	P1-25/M4/SVB-SW/N/HI11	172770	1	✓			
			3+N	1	1	32 A	P1-32/M4/SVB-SW/N/HI11	172872	1	✓			
	Padlockable K-Line K1 Knob		3+N	1	1	40 A	P1-40/M4/SVB-SW/N/HI11	199943	1	✓			
			3+N	1	1	63 A	P3-63/M4/SVB-SW/N/HI11	172809	1	✓			
			3+N	1	1	100 A	P1-25/M4/SVB-SW/N/HI11	172770	1	✓			
			3	1	1	25 A	P1-25/M4/K1-PG/HI11	172781	1	✓			
			3	1	1	32 A	P1-32/M4/K1-PG/HI11	172776	1	✓			
			3+N	1	1	25 A	P1-25/M4/K1-PG/N/HI11	172864	1	✓			
Padlockable K-Line K2 Knob		3+N	1	1	32 A	P1-32/M4/K1-PG/N/HI11	172783	1	✓				
		3	1	1	63 A	P3-63/M4/K1-PG/N/HI11	172815	1	✓				
		3	1	1	100 A	P3-100/M4/K1-PG/N/HI11	172831	1	✓				
		3+N	1	1	63 A	P3-63/M4/K1-PG/N/HI11	172817	1	✓				
			3+N	1	1	100 A	P3-100/M4/K1-PG/N/HI11	172833	1	✓			











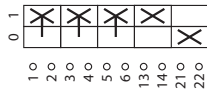

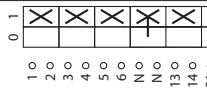

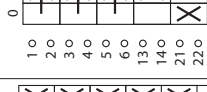
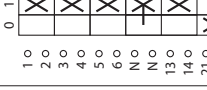
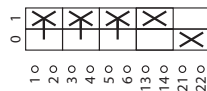
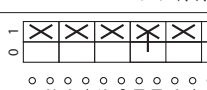
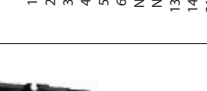
172870

Photo is representative

# Rear mounting - Main switch-disconnectors with 400 mm metal extension shaft with auxiliary contacts

With emergency switch off/emergency stop function

Front plate	Handle type	Contact sequence	Number of poles	Auxiliary contact			Rated current	Part number	Article number	Pack qty	Suitable for export to North America (US) and Canada
				N/O	N/O	N/C					
 FS 908	Padlockable main switch handle		3	1	1	25 A	P1-25/M4/SVB/HI11	<a href="#">172767</a>	1	✓	
			3	1	1	32 A	P1-32/M4/SVB/HI11	<a href="#">172869</a>	1	✓	
			3	1	1	40 A	P1-40/M4/SVB/HI11	<a href="#">199937</a>	1	✓	
			3	1	1	63 A	P3-63/M4/SVB/HI11	<a href="#">172788</a>	1	✓	
			3	1	1	100 A	P3-100/M4/SVB/HI11	<a href="#">172822</a>	1	✓	
			3 + N	1	1	25 A	P1-25/M4/SVB/N/HI11	<a href="#">172769</a>	1	✓	
	Padlockable K-Line K1 Knob		3 + N	1	1	32 A	P1-32/M4/SVB/N/HI11	<a href="#">172871</a>	1	✓	
			3 + N	1	1	40 A	P1-40/M4/SVB/N/HI11	<a href="#">199939</a>	1	✓	
			3 + N	1	1	100 A	P3-100/M4/SVB/N/HI11	<a href="#">172824</a>	1	✓	
			3	1	1	25 A	P1-25/M4/K1-PR/HI11	<a href="#">172775</a>	1	✓	
			3	1	1	32 A	P1-32/M4/K1-PR/HI11	<a href="#">172780</a>	1	✓	
			3 + N	1	1	25 A	P1-25/M4/K1-PR/N/HI11	<a href="#">172777</a>	1	✓	
Padlockable K-Line K2 Knob		3 + N	1	1	32 A	P1-32/M4/K1-PR/N/HI11	<a href="#">172782</a>	1	✓		
		3	1	1	63 A	P3-63/M4/K2-PR/HI11	<a href="#">172814</a>	1	✓		
		3	1	1	100 A	P3-100/M4/K2-PR/HI11	<a href="#">172830</a>	1	✓		
		3 + N	1	1	63 A	P3-63/M4/K2-PR/N/HI11	<a href="#">172816</a>	1	✓		
			3 + N	1	1	100 A	P3-100/M4/K2-PR/N/HI11	<a href="#">172832</a>	1	✓	













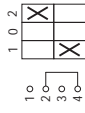

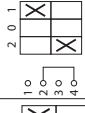

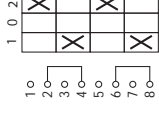

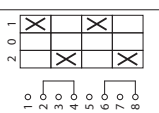

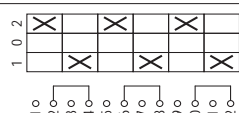

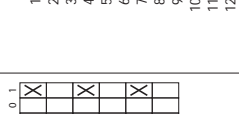
199939

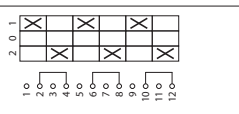
Photo is representative

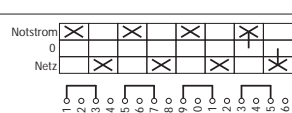

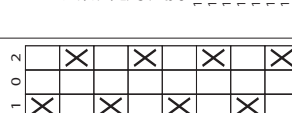
# Rear mounting - Changeover switch-disconnectors

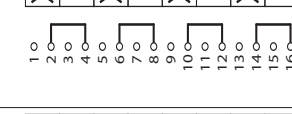
## Without emergency switch off/emergency stop function

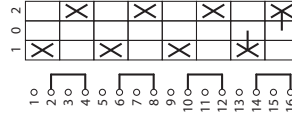
Front plate	Contact sequence	Number of poles N/O	Rated current	Part number	Article number	Pack qty	Suitable for export to North America (US and Canada)	Padlockable handle
 FS 684		1	20 A	T0-1-8210/Z	<a href="#">019862</a>	1	✓	X
			32 A	T3-1-8210/Z	<a href="#">057091</a>	1	✓	X
			63 A	T5B-1-8210/Z	<a href="#">094258</a>	1	✓	X
 FS 429		1	20 A	T0-1-15421/Z	<a href="#">015125</a>	1	✓	X
			20 A	T0-2-8211/Z	<a href="#">029354</a>	1	✓	X
			32 A	T3-2-8211/Z	<a href="#">064210</a>	1	✓	X
 FS 684		2	20 A	T0-2-8211/Z	<a href="#">029354</a>	1	✓	X
			32 A	T3-2-8211/Z	<a href="#">064210</a>	1	✓	X
			63 A	T5B-2-8211/Z	<a href="#">093082</a>	1	✓	X
 FS 429		2	20 A	T0-2-15422/Z	<a href="#">029363</a>	1	✓	X
			20 A	T0-3-8212/Z	<a href="#">036473</a>	1	✓	X
			32 A	T3-3-8212/Z	<a href="#">071329</a>	1	✓	X
 FS 684		3	20 A	T0-3-8212/Z	<a href="#">036473</a>	1	✓	X
			32 A	T3-3-8212/Z	<a href="#">071329</a>	1	✓	X
			63 A	T5B-3-8212/Z	<a href="#">092383</a>	1	✓	X
 FS 429		3	20 A	T0-3-8212/Z	<a href="#">036473</a>	1	✓	X
			63 A	T5B-3-8212/Z	<a href="#">092383</a>	1	✓	X
			100 A	T5-3-8212/Z	<a href="#">096464</a>	1	X	X
 FS 429		3	20 A	T0-3-15423/Z	<a href="#">043601</a>	1	✓	X
			32 A	T3-4-8902/Z	<a href="#">215225</a>	1	✓	X
			63 A	T5B-4-8902/Z	<a href="#">207431</a>	1	✓	X
 FS 161629		4	32 A	T3-4-8902/Z	<a href="#">215225</a>	1	✓	X
			63 A	T5B-4-8902/Z	<a href="#">207431</a>	1	✓	X
			100 A	T5-4-8902/Z	<a href="#">207419</a>	1	X	X
 FS 684		4	20 A	T0-4-8213/Z	<a href="#">043592</a>	1	✓	X
			32 A	T3-4-8213/Z	<a href="#">078448</a>	1	✓	X
			63 A	T5B-4-8213/Z	<a href="#">092109</a>	1	✓	X
 FS 684		4	20 A	T0-4-8213/Z	<a href="#">043592</a>	1	✓	X
			32 A	T3-4-8213/Z	<a href="#">078448</a>	1	✓	X
			63 A	T5B-4-8213/Z	<a href="#">092109</a>	1	✓	X
 FS 953		4	32 A	T3-4-8294/Z	<a href="#">004886</a>	1	✓	X
			63 A	T5B-4-8294/Z	<a href="#">092081</a>	1	✓	X
			100 A	T5-4-8294/Z	<a href="#">095984</a>	1	X	X





092383

Photo is representative

# Rear mounting - Changeover switch-disconnectors

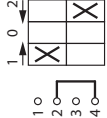
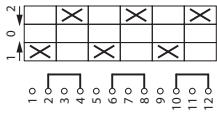
## Without emergency switch off/emergency stop function

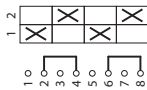
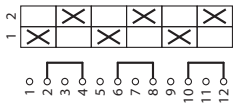
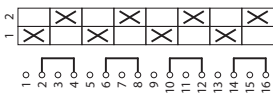
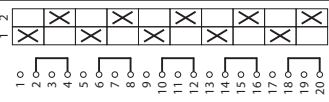
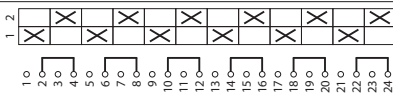
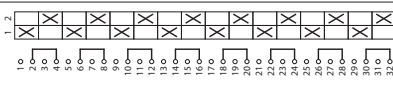
Front plate	Contact sequence	Number of poles N/O	Rated current	Part number	Article number	Pack qty	Suitable for export to North America (US and Canada)	Padlockable handle
<b>With Automatic (spring) return from both directions</b>								
 FS 4011		1	20 A	T0-1-8214/Z	<a href="#">050720</a>	1	X	X
		3	20 A	T0-3-8216/Z	<a href="#">055466</a>	1	✓	X
<b>Two way switch-disconnector - Without O (OFF) position</b>								
 FS 943		1	20 A	T0-1-8220/Z	<a href="#">086312</a>	1	✓	X
		2	20 A	T0-2-8221/Z	<a href="#">074450</a>	1	✓	X
			32 A	T3-2-8221/Z	<a href="#">047600</a>	1	✓	X
			63 A	T5B-2-8221/Z	<a href="#">093044</a>	1	✓	X
		3	20 A	T0-3-8222/Z	<a href="#">088686</a>	1	✓	X
			32 A	T3-3-8222/Z	<a href="#">057092</a>	1	✓	X
			63 A	T5B-3-8222/Z	<a href="#">092375</a>	1	✓	X
		4	20 A	T0-4-8223/Z	<a href="#">086315</a>	1	✓	X
			32 A	T3-4-8223/Z	<a href="#">061838</a>	1	✓	X
			63 A	T5B-4-8223/Z	<a href="#">092105</a>	1	✓	X
		5	32 A	T3-5-8369/Z	<a href="#">068957</a>	1	✓	X
		6	20 A	T0-6-8370/Z	<a href="#">010380</a>	1	✓	X
		8	20 A	T0-8-8372/Z	<a href="#">012753</a>	1	✓	X
			32 A	T3-8-8372/Z	<a href="#">083195</a>	1	✓	X



010380







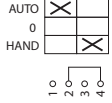
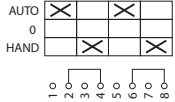
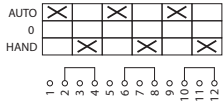

050720

Photos are representative

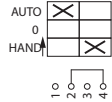
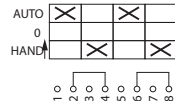
# Rear mounting - Manual/auto switch-disconnectors

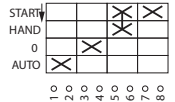
## Without emergency switch off/emergency stop function

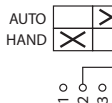
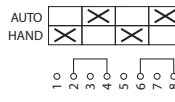
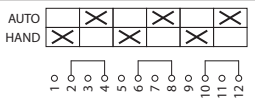
Front plate	Contact sequence	Number of poles N/O	Rated current	Part number	Article number	Pack qty	Suitable for export to North America (US and Canada)	Padlockable handle
<b>With 0 (Off) position</b>								
 FS 1401		1	20 A	T0-1-15431/Z	029364	1	✓	X
		2	20 A	T0-2-15432/Z	043602	1	✓	X
		3	20 A	T0-3-15433/Z	057840	1	✓	X
<b>With Automatic (spring) return from HAND</b>								
 FS 1414000		1	20 A	T0-1-15434/Z	072078	1	✓	X
		2	20 A	T0-2-15435/Z	003196	1	✓	X
<b>With Automatic (spring) return from START</b>								
 FS 1413890		2	20 A	T0-2-15907/Z	078796	1	✓	X
<b>Without 0 (Off) position</b>								
 FS 19334		1	20 A	T0-1-15451/Z	086316	1	✓	X
		2	20 A	T0-2-15452/Z	010381	1	✓	X
		3	20 A	T0-3-15453/Z	024619	1	✓	X



010381

Photo is representative

# Rear mounting - Multi speed switch-disconnectors

## Without emergency switch off/emergency stop function











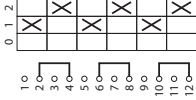

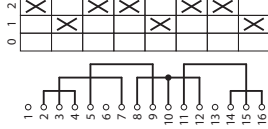

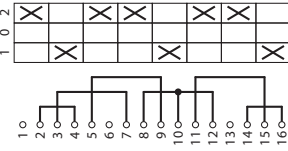

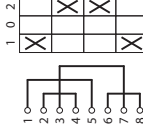
Front plate	Contact sequence	Number of poles N/O	Rated current	Part number	Article number	Pack qty	Suitable for export to North America (US and Canada)	Padlockable handle
<b>2 speed, non reversing, for 2 separate windings</b>								
 FS 644		6	20 A	T0-3-8451/Z	<a href="#">043596</a>	1	✓	X
			32 A	T3-3-8451/Z	<a href="#">031014</a>	1	✓	X
<b>2 speed, 2 directions, for one tapped winding</b>								
 FS 644		3	20 A	T0-4-8440/Z	<a href="#">048342</a>	1	✓	X
			32 A	T3-4-8440/Z	<a href="#">038133</a>	1	✓	X
			63 A	T5B-4-8440/Z	<a href="#">092029</a>	1	✓	X
 FS 684		3	20 A	T0-4-8441/Z	<a href="#">053088</a>	1	✓	X
			32 A	T3-4-8441/Z	<a href="#">045252</a>	1	✓	X
			63 A	T5B-4-8441/Z	<a href="#">092025</a>	1	✓	X

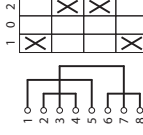

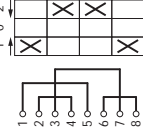
Photo is representative

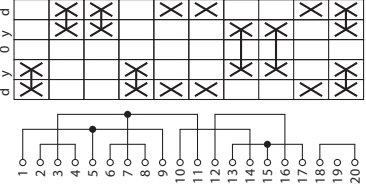
# Rear mounting - Reversing switch-disconnectors

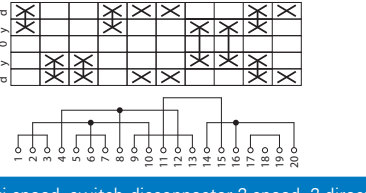
## Without emergency switch off/emergency stop function

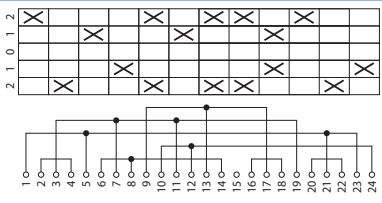
Front plate	Contact sequence	Number of poles N/O	Rated current	Part number	Article number	Pack qty	Suitable for export to North America (US and Canada)	Padlockable handle
<b>Reversing switch-disconnector - Without Automatic (spring) return to 0 (Off) position</b>								
 FS 684		2	20 A	T0-2-8400/Z	062571	1	✓	X
			32 A	T3-2-8400/Z	095060	1	✓	X
 FS 684		2	20 A	T0-3-8401/Z	010366	1	✓	X
			32 A	T3-3-8401/Z	035739	1	✓	X
			63 A	T5B-3-8401/Z	092293	1	✓	X
<b>Reversing switch-disconnector - With Automatic (spring) return from both directions to 0 (Off position)</b>								
 FS 4011		3	20 A	T0-3-8228/Z	074437	1	✓	X
			32 A	T3-3-8228/Z	004911	1	✓	X
<b>Reversing star delta switch-disconnector - Two-way operating direction</b>								
 FS 638		3	20 A	T0-5-15876/Z	000942	1	✓	X
			32 A	T3-5-15876/Z	019149	1	✓	X
 FS 4017		3	63 A	T5B-5-15876/Z	214786	1	✓	X
<b>Reversing multi speed, switch-disconnector 2 speed, 2 directions, for one tapped winding</b>								
 FS 629			20 A	T0-6-15866/Z	067326	1	✓	X
			32 A	T3-6-15866/Z	057117	1	✓	X



074437









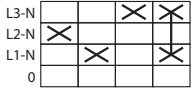
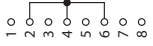

214786

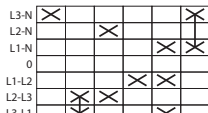
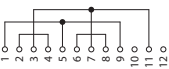
Photos are representative

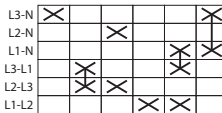
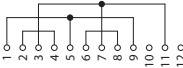
# Rear mounting - Selector switch-disconnectors

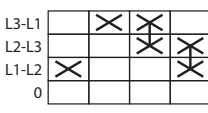
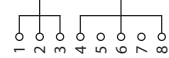
## Without emergency switch off/emergency stop function

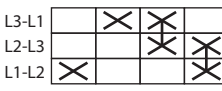
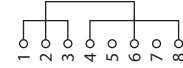
Front plate	Contact sequence	Number of poles	Pole N/O	Rated current	Part number	Article number	Pack qty	Suitable for export to North America (US and Canada)	Padlockable handle
<b>Voltmeter</b>									
		3 x phase-N with 0 position	3+N	20 A	T0-2-15921/Z	076829	1	✓	X
FS 1410757									
		3 x phase-phase 3 x phase-N with 0 position	3+N	20 A	T0-3-8007/Z	015132	1	✓	X
FS 1410759									
		3 x phase-phase 3 x phase-N without 0 position with complete rotation in both directions	3+N	20 A	T0-3-15924/Z	029370	1	✓	X
FS 164721									
		3 x phase-phase with 0 position	3+N	20 A	T0-2-15920/Z	048353	1	✓	X
FS 1410755									
		3 x phase-phase without 0 position	3+N	20 A	T0-2-15922/Z	062591	1	✓	X
FS 164854									



015132

Photo is representative

# Rear mounting - Star delta switch-disconnectors

## Without emergency switch off/emergency stop function

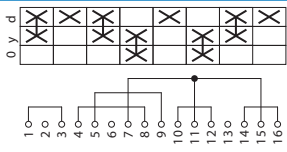
Front plate	Contact sequence	Number of poles N/O	Rated current	Part number	Article number	Pack qty	Suitable for export to North America (US and Canada)	Padlockable handle
 FS 635		3	20 A	T0-4-8410/Z	083929	1	X	X
			32 A	T3-4-8410/Z	012030	1	✓	X
			63 A	T5B-4-8410/Z	092049	1	✓	X











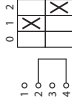

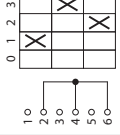

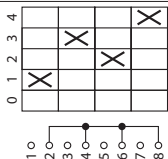
012030

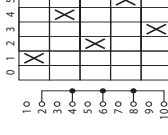
Photo is representative

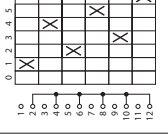
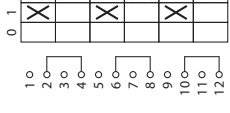
# Rear mounting - Step switch-disconnectors

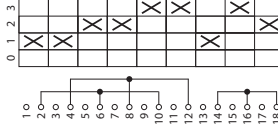
## Without emergency switch off/emergency stop function

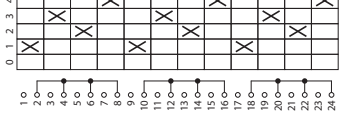
Front plate	Contact sequence	Number of poles N/O	Rated current	Part number	Article number	Pack qty	Suitable for export to North America (US and Canada)	Padlockable handle
With 0 (Off) position								
 FS 418		1	20 A	T0-1-8240/Z	<a href="#">060208</a>	1	✓	X
 FS 420		1	20 A	T0-2-8241/Z	<a href="#">062581</a>	1	✓	X
 FS 422		1	20 A	T0-2-8242/Z	<a href="#">076819</a>	1	✓	X
 FS 424		1	20 A	T0-3-8243/Z	<a href="#">091057</a>	1	✓	X
 FS 426		1	20 A	T0-3-8244/Z	<a href="#">015122</a>	1	✓	X
 FS 418		3	20 A	T0-3-8280/Z	<a href="#">043598</a>	1	✓	X
 FS 420		3	20 A	T0-5-8281/Z	<a href="#">057836</a>	1	✓	X
 FS 422		3	20 A	T0-6-8282/Z	<a href="#">072074</a>	1	✓	X













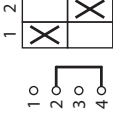

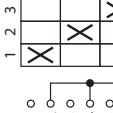

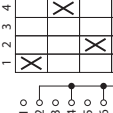
057836

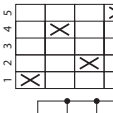
Photo is representative

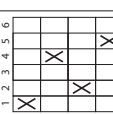

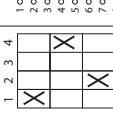
# Rear mounting - Step switch-disconnectors

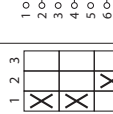
## Without emergency switch off/emergency stop function

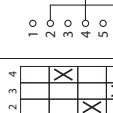
Front plate	Contact sequence	Number of poles N/O	Rated current	Part number	Article number	Pack qty	Suitable for export to North America (US and Canada)	Padlockable handle
<b>Without 0 (Off) position</b>								
 FS 943		1	20 A	T0-1-8220/Z	<a href="#">086312</a>	1	✓	X
 FS 404		1	20 A	T0-2-8230/Z	<a href="#">098177</a>	1	✓	X
 FS 606		1	20 A	T0-2-8231/Z	<a href="#">022242</a>	1	✓	X
 FS 408		1	20 A	T0-3-8232/Z	<a href="#">036480</a>	1	✓	X
 FS 410		1	20 A	T0-3-8233/Z	<a href="#">050718</a>	1	✓	X
 FS 406		2	20 A	T0-3-8251/Z	<a href="#">013976</a>	1	✓	X
 FS 404		3	20 A	T0-5-8270/Z	<a href="#">010378</a>	1	✓	X
 FS 406		3	20 A	T0-6-8271/Z	<a href="#">024616</a>	1	✓	X



098177

Photo is representative

# Rear mounting - Universal control switch-disconnectors

## Without emergency switch off/emergency stop function

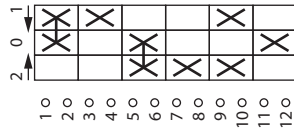
Front plate	Contact sequence	Rated current	Part number	Article number	Pack qty	Suitable for export to North America (US and Canada)	Padlockable handle
Automatic (spring) return from positions 1 and 2							
 FS 458		20 A	T0-3-15394/Z	081571	1	✓	X



081571

Photo is representative

# Rear mounting dedicated accessories

## Neutral conductor

- Early make on switching, late-break off switching
- The N contact always behaves as an early-make contact when switching on and as a late-break contact for when switching off.
- N-P1(P3)...switching capacity same as for contacts P1(P3)

Description	Part number	Article number	Std. pack	Suitable for export to North America (US and Canada)	Suitable for	Mounting
Neutral conductor	N-P1Z	000652	5	✓	P1	Rear mounting /Z
	N-P3Z	064805	5	✓	P3	Rear mounting /Z



## Neutral terminal

- Front mounting, left
- Service distribution board mounting right

Description	Part number	Article number	Std. pack	Suitable for export to North America (US and Canada)	Suitable for	Mounting
Neutral terminal	N-P5-125/160Z	280970	1	X	P5-125 and 160	Rear mounting /V
	N-P5-250/315Z	280972	1	X	P5-250 and 315	Rear mounting /V



## Ground terminal

- Front mounting, right
- Service distribution board mounting left

Description	Part number	Article number	Std. pack	Suitable for export to North America (US and Canada)	Suitable for	Mounting
Ground terminal	PE-P5-125/160Z	280974	1	X	P5-125 and 160	Rear mounting /V
	PE-P5-250/315Z	280976	1	X	P5-250 and 315	Rear mounting /V



## Auxiliary contacts - 1 normally open (N/O), 1 normally close (N/C)

- Late break on switching, early-make off switching. The N/O is always connected as a load-shedding contact

Description	Part number	Article number	Std. pack	Suitable for export to North America (US and Canada)	Suitable for	Mounting
Auxiliary contacts	HI11-P1/P3Z	062031		✓	P1	Rear mounting /V or /Z
				✓	P3-63	Rear mounting /V or /Z
				✓	P3-100	Rear mounting /V or /Z

Product standards	UL 60947-4-1, CSA - C22-2 No 14-05 IEC/EN 60947-3, CE Marking
UL File No	E36332
UL CCN	NLRV
CSA File No	12528
CSA Class No	3211-05
NA Certification	UL Listed, CSA Certified



Photos are representative

## Rear mounting dedicated accessories

### Auxiliary contacts - 2 normally open (N/O), 1 normally close (N/C)

Description	Part number	Article number	Std. pack	Suitable for export to North America (US and Canada)	Suitable for	Mounting
Auxiliary contact for left and/or right side mounting	HI21-P5-125/160Z	280964	1	X	P5-125 and 160	Rear mounting /V or Z
	HI21-P5-250/315Z	280966	1	X	P5-250 and 315	Rear mounting /V or Z



### Maintenance key for interlocked main switches

Special devices for electricians: interlocked main switches can be switched on and off for repairs with the maintenance key while the door is open (as per IEC/EN 60204-1, Section 5.1.1.1)

Description	Part number	Article number	Std. pack	Suitable for export to North America (US and Canada)	Suitable for	Mounting
Maintenance key for interlocked main switches	KNK-T0	000650	5	✓	T0, T3, P1	Rear mounting /Z
	KNK-P3	000649	5	✓	P3, T5, T5B	Rear mounting /Z



### Interlock extensions

A maximum of 4 units can be plugged on the interlock section every 25 mm (an equal number of shaft extensions is required for this)

Description	Part number	Article number	Std. pack	Suitable for export to North America (US and Canada)*	Suitable for	Mounting
Interlock extension	ZVV-T0	022298	10	✓	T0, T3	Rear mounting /Z
	ZVV-P3	024671	10	✓	T5B, T5	Rear mounting /Z



\* UL/CSA certification not required

### Shaft

Description	Part number	Article number	Std. pack	Suitable for export to North America (US and Canada)	Suitable for	Mounting
Aluminium shaft, 480 mm length	ZAV-P5	280979	1	✓	P5	Rear mounting /V



### Shaft extensions

A maximum of 4 units can be put on the switch shaft every 25 mm

Description	Part number	Article number	Std. pack	Suitable for export to North America (US and Canada)	Suitable for	Mounting
Shaft extension	ZAV-T0	027044	10	✓	T0, T3, P1	Rear mounting /V or /Z
	ZAV-P3	029417	10	✓	P3	Rear mounting /V or /Z



### Interlock extensions and shaft extensions

Description	Part number	Article number	Std. pack	Suitable for export to North America (US and Canada)	Suitable for	Mounting
Extension to 25 mm when ordering with basic unit	+ZAV(X1)+ZVV(X1)-T0/P3	254546	1	✓	P5	Rear mounting /Z



Photos are representative

# Rear mounting dedicated accessories

## Main switches accessories

### Basic switches, Type P/XM

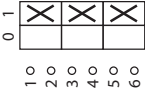
Front plate	Contact sequence	Number of poles	Rated current	Part number	Article number	Pack qty
 FS 908		3	25 A	P1-25/XM	172834	1
		3	32 A	P1-32/XM	172835	1
		3	40 A	P1-40/XM	199888	1
		3	63 A	P3-63/XM	172836	1
		3	100 A	P3-100/XM	172837	1



172836

## Accessories for P/XM Switch-disconnectors

### K-Line handles

Description	Suitable for	Colour	Locking mechanism	Part number	Article number	Pack qty	Feature
Knob	P1	Blue	Padlockable	K1DB/P	1818029	1	Knobs and handles provide door interlock when in the ON position and also when locked in the OFF position.
Knob	P1	Red/Yellow	Padlockable	K1DR/P	1818030	1	
Knob	P1	Grey	Padlockable	K1DG/P	1818031	1	
Knob	P3	Blue	Padlockable	K2SDB/P	1818032	1	The door interlock can also be defeated in the ON position by using a special tool.
Knob	P3	Red/Yellow	Padlockable	K2SDR/P	1818033	1	
Knob	P3	Grey	Padlockable	K2SDG/P	1818034	1	
Knob	P3	Blue	Cylinder lock/key	K2SDB/C	1818038	1	Lockable with up to 2 x 6 mm padlocks or cylinder locks
Knob	P3	Red/Yellow	Cylinder lock/key	K2SDR/C	1818039	1	
Knob	P3	Grey	Cylinder lock/key	K2SDG/C	1818040	1	



1818029



1818033

### Black knobs and lockable main switch handles

Description	Suitable for	Colour	Part number	Article number	Pack qty	Feature
Knob	P1	Black	KNB-P1/M	172838	1	Door interlocked when in the ON position
Knob	P3	Black	KNB-P3/M	172839	1	
Lockable main switch handle	P1	Red/Yellow	SVB-P1/M	172840	1	Can be locked in the OFF position with up to 3 x 8 mm padlocks
Lockable main switch handle	P3	Red/Yellow	SVB-P3/M	172841	1	
Lockable main switch handle	P1	Black	SVB-SW-P1/M	172842	1	
Lockable main switch handle	P3	Black	SVB-SW-P3/M	172843	1	



172839

### Metal shafts

Length	Part number	Article number	Pack qty
400 mm	P1/P3-M400	172844	10
600 mm	P1/P3-M600	172845	10



172844

Photos are representative

# Rear mounting dedicated accessories

## IP65 Insulated enclosures

Description	Number of contact units	Part number	Article number	Std. pack	Suitable for export to North America (US and Canada)	Suitable for	Mounting
IP65 insulated enclosure - With push-through cable entry diaphragm*	1-2	CI-K1-T0-2	<a href="#">207435</a>	1	X	T0	Rear mounting /Z
	3-4	CI-K1-T0-4	<a href="#">207436</a>	1	X		
	1-2	CI-K2-T3-2	<a href="#">207437</a>	1	✓	T3	Rear mounting /Z
	3-4	CI-K2-T3-4	<a href="#">225325</a>	1	✓		
	5	CI-K2-T3-5	<a href="#">207438</a>	1	✓		
IP65 insulated enclosure - With metric knockouts	1-2	CI-K1H-T0-2	<a href="#">105854</a>	1	X	T0	Rear mounting /Z
	3-4	CI-K1H-T0-4	<a href="#">105855</a>	1	X		
	1-2	CI-K2H-T3-2	<a href="#">269462</a>	1	X	T3	Rear mounting /Z
	3-4	CI-K2H-T3-4	<a href="#">105859</a>	1	X		
	5	CI-K2H-T3-5	<a href="#">105860</a>	1	X		
	3-4	CI-K4-T5B-4**	<a href="#">207440</a>	1	✓	T5B	Rear mounting /Z
	1-2	CI-K5-T5-2**	<a href="#">207441</a>	1	✓	T5	Rear mounting /Z
	3-4	CI-K5-T5-4**	<a href="#">207442</a>	1	✓		

\* The diaphragm can be pierced with the cable. 1 contact unit = 2 contacts.

\*\* For converting T5-./Z into T5-./I5 and T5B-./E into T5B-./I4, order AW-T5... extension terminal additionally. 1 contact unit = 2 contacts



207435 / 207436  
105855 /

207437 / 269462  
105859 / 105860

225325

207438

105854

207440

207441

Product standards	UL 60947-4-1, CSA - C22-.2 No 14-05, CSA - C22-2 No 94 IEC/EN 60947-3, CE Marking
UL File No	E54120
UL CCN	MITW2
CSA File No	12528
CSA Class No	3211-07
NA Certification	UL Listed, CSA Certified
Degree of protection	IEC: IP65 UL/CSA Type 1, 3R, 4X, 12, 13 - indoor and outdoor use

Photos are representative

# Service distribution board mounting switch-disconnectors

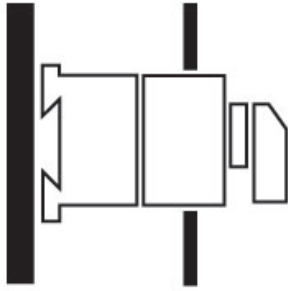

## Description

Service distribution board switch-disconnectors can be easily installed directly onto the DIN-Rail inside the distribution board enclosure.

## Standards/Approvals

See details page 178

## Technical data

- Voltage: 690 V a.c.
- Current: 10 A to 100 A

## Features

- Available with or without emergency switching off/emergency stop function
- Available with and without auxiliary contacts
- Available with red rotary handle and yellow locking collar and black rotary handle and locking collar
- 1-pole to 8-pole options



T0 Service distribution board mounting



T0 Service distribution board mounting

Photos are representative











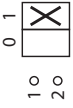

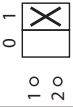
## Service distribution board mounting - Range overview

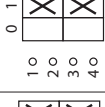
Rated current	10 A	20 A	25 A	32 A	40 A	63 A	100 A
On-Off switch-disconnectors		T0	P1	P1	P1	P3	P3
Without auxiliary contacts		✓	✓	✓	✓	✓	✓
With auxiliary contacts		✓					
Changeover switch-disconnectors		T0					
Without auxiliary contacts		✓					
Coding switch-disconnectors		T0					
Without auxiliary contacts		✓					
Heater switch-disconnectors		T0					
Without auxiliary contacts		✓					
Manual/auto switch-disconnectors	TM	T0					
Without auxiliary contacts	✓	✓					
Multi speed switch-disconnectors		T0					
Without auxiliary contacts		✓					
Reversing switch-disconnectors		T0					
Without auxiliary contacts		✓					
Selector switch-disconnectors		T0					
Without auxiliary contacts		✓					
Star delta switch-disconnectors		T0					
Without auxiliary contacts		✓					
Step switch-disconnectors		T0					
Without auxiliary contacts		✓					
Universal switch-disconnectors		T0					
Without auxiliary contacts		✓					

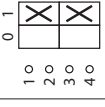

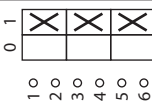
# Service distribution board mounting - On-Off switch-disconnectors without auxiliary contacts

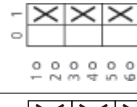
## Without emergency switch off/emergency stop function

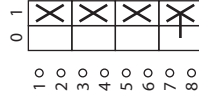
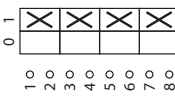
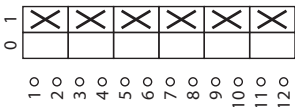
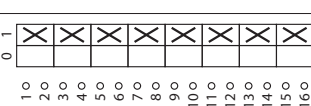
Front plate	Contact sequence	Number of poles N/O	Rated current	Part number	Article number	Pack qty	Suitable for export to North America (US and Canada)	Padlockable handle
 FS 908		1	20 A	T0-1-8200/IVS	074471	1	✓	X
 FS 415		1	20 A	T0-1-15401/IVS	045973	1	✓	X
 FS 908		2	20 A	T0-1-102/IVS	015147	1	✓	X
 FS 415		2	20 A	T0-1-15402/IVS	060211	1	✓	X
 FS 908		3	20 A	T0-2-1/IVS	031758	1	✓	X
			25 A	P1-25/IVS	052962	1	✓	X
			32 A	P1-32/IVS	093303	1	✓	X
			40 A	P1-40/IVS	199931	1	X	X
			63 A	P3-63/IVS	041099	1	✓	X
			100 A	P3-100/IVS	081439	1	✓	X
 FS 415		3	20 A	T0-2-15403/IVS	074449	1	✓	X
 FS 908		3 + N	20 A	T0-2-8900/IVS	207403	1	✓	X
			25 A	P1-25/IVS/N	083964	1	✓	X
			32 A	P1-32/IVS/N	010402	1	✓	X
			40 A	P1-40/IVS/N	199933	1	X	X
			63 A	P3-63/IVS/N	022267	1	✓	X
			100 A	P3-100/IVS/N	034132	1	✓	X
	4	20 A	T0-2-1540/IVS	088687	1	✓	X	
	6	20 A	T0-3-8342/IVS	050743	1	✓	X	
	8	20 A	T0-4-8344/IVS	014006	1	✓	X	



050743

Photo is representative

# Service distribution board mounting - On-Off switch-disconnectors without auxiliary contacts

## Without emergency switch off/emergency stop function

Front plate	Contact sequence	Number of poles N/O	Rated current	Part number	Article number	Pack qty	Suitable for export to North America (US and Canada)	Padlockable handle
<b>With Automatic (spring) return in START position</b>								
		1	20 A	T0-1-15511/IVS	026994	1	✓	X
FS 147767								
		2	20 A	T0-2-8177/IVS	022249	1	✓	X
FS 140660								
<b>Automatic (spring) return from position 1</b>								
		1	20 A	T0-1-15321/IVS	093436	1	✓	X
FS 4721								
		2	20 A	T0-1-15322/IVS	017501	1	✓	X
		3	20 A	T0-2-15323/IVS	031739	1	✓	X





026994

Photo is representative

# Service distribution board mounting - On-Off switch-disconnectors without auxiliary contacts

## With emergency switch off/emergency stop function

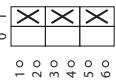
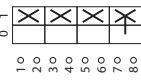
Front plate	Contact sequence	Number of poles N/O	Rated current	Part number	Article number	Pack qty	Suitable for export to North America (US and Canada)	Padlockable handle
 FS 908		1	20 A	T0-1-8200/IVS-RT	081956	1	✓	X
		2	20 A	T0-1-102/IVS-RT	079583	1	✓	X
		3	20 A	T0-2-1/IVS-RT	084329	1	✓	X
		25 A	P1-25/IVS-RT	013140	1	✓	X	
		32 A	P1-32/IVS-RT	022632	1	✓	X	
		40 A	P1-40/IVS-RT	199935	1	X	X	
		63 A	P3-63/IVS-RT	045845	1	✓	X	
		3-N	20 A	T0-2-8900/IVS-RT	207404	1	✓	X



084329

Photo is representative

# Service distribution board mounting - On-Off switch-disconnectors with auxiliary contacts

## Without emergency switch off/emergency stop function

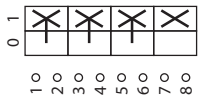
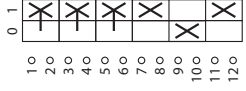
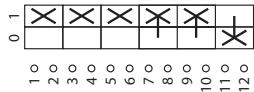
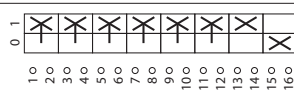
Front plate	Contact sequence	Number of poles			Rated current	Part number	Article number	Pack qty	Suitable for export to North America (US and Canada)	Padlockable handle
		N/O	N/O	N/C						
 FS 908	 1 0 2 0 3 0 4 0 5 0 6 0 7 0 8 0	3	1	0	20 A	T0-2-15679/IVS	036506	1	✓	X
	 1 0 2 0 3 0 4 0 5 0 6 0 7 0 8 0 9 0 10 0 11 0 12 0	3	2	1	20 A	T0-3-15683/IVS	016722	1	✓	X
	 1 0 2 0 3 0 4 0 5 0 6 0 7 0 8 0 9 0 10 0 11 0 12 0	3+N	1	1	20 A	T0-3-8901/IVS	231940	1	✓	X
	 1 0 2 0 3 0 4 0 5 0 6 0 7 0 8 0 9 0 10 0 11 0 12 0 13 0 14 0 15 0 16 0	6	1	1	20 A	T0-4-15682/IVS	017524	1	✓	X



231940

Photo is representative

# Service distribution board mounting - Changeover switch-disconnectors

## Without emergency switch off/emergency stop function



Front plate	Contact sequence	Number of poles N/O	Rated current	Part number	Article number	Pack qty	Suitable for export to North America (US and Canada)	Padlockable handle
		1	20 A	T0-1-8210/IVS	<a href="#">074440</a>	1	✓	X
FS 684								
		1	20 A	T0-1-15421/IVS	<a href="#">012752</a>	1	✓	X
FS 429								
		2	20 A	T0-2-8211/IVS	<a href="#">076813</a>	1	✓	X
FS 684								
		2	20 A	T0-2-15422/IVS	<a href="#">026990</a>	1	✓	X
FS 429								
		3	20 A	T0-3-8212/IVS	<a href="#">079186</a>	1	✓	X
FS 684								
		3	20 A	T0-3-15423/IVS	<a href="#">041228</a>	1	✓	X
FS 429								
		4	20 A	T0-4-8213/IVS	<a href="#">081559</a>	1	✓	X
FS 684								
		4	20 A	T0-4-8294/IVS	<a href="#">043594</a>	1	✓	X
FS 953								
		1	20 A	T0-1-8214/IVS	<a href="#">045967</a>	1	✓	X
FS 4011								
		2	20 A	T0-2-8215/IVS	<a href="#">048340</a>	1	✓	X
		3	20 A	T0-3-8216/IVS	<a href="#">050713</a>	1	✓	X



Photo is representative

# Service distribution board mounting - Changeover switch-disconnectors

## Without emergency switch off/emergency stop function

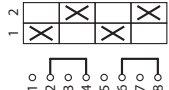
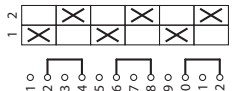
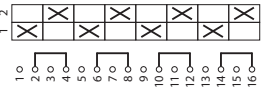
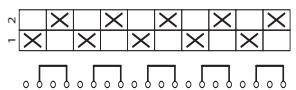
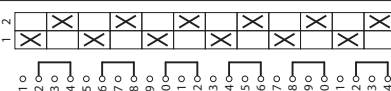
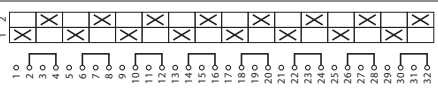
Front plate	Contact sequence	Number of poles N/O	Rated current	Part number	Article number	Pack qty	Suitable for export to North America (US and Canada)	Padlockable handle
Two way switch-disconnector without the O (OFF) position								
 FS 943		1	20 A	T0-1-8220/IVS	<a href="#">055459</a>	1	✓	X
		2	20 A	T0-2-8221/IVS	<a href="#">057832</a>	1	✓	X
		3	20 A	T0-3-8222/IVS	<a href="#">060205</a>	1	✓	X
		4	20 A	T0-4-8223/IVS	<a href="#">062578</a>	1	✓	X
		5	20 A	T0-5-8369/IVS	<a href="#">064951</a>	1	✓	X
		6	20 A	T0-6-8370/IVS	<a href="#">067324</a>	1	✓	X
		8	20 A	T0-8-8372/IVS	<a href="#">069697</a>	1	✓	X



064951

Photo is representative

# Service distribution board mounting - Coding switch-disconnectors

## Without emergency switch off/emergency stop function









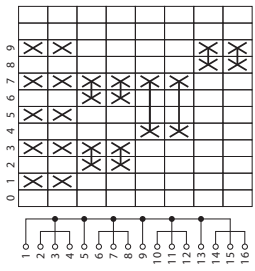

Front plate	Contact sequence	Rated current	Part number	Article number	Pack qty	Suitable for export to North America (US and Canada)	Padlockable handle
With complete rotation in both directions - Binary BCD Code							
 FS 312		20 A	T0-4-15602/IVS	036487	1	✓	X

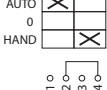
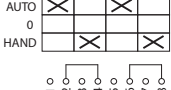
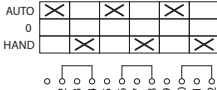

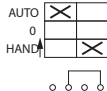
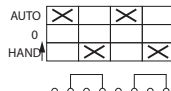
Photo is representative

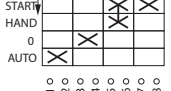
# Service distribution board mounting - Manual/auto switch-disconnectors

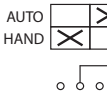
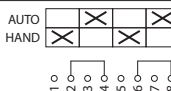
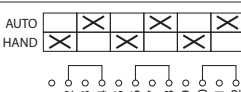
## Without emergency switch off/emergency stop function

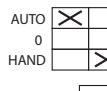
Front plate	Contact sequence	Number of poles N/O	Rated current	Part number	Article number	Pack qty	Suitable for export to North America (US and Canada)	Padlockable handle
<b>With 0 (Off) position</b>								
 FS 1401		1	20 A	T0-1-15431/IVS	026991	1	✓	X
		2	20 A	T0-2-15432/IVS	041229	1	✓	X
		3	20 A	T0-3-15433/IVS	055467	1	✓	X
<b>With Automatic (spring) return from HAND</b>								
 FS 1414000		1	20 A	T0-1-15434/IVS	069705	1	✓	X
		2	20 A	T0-2-15435/IVS	003195	1	✓	X
<b>With Automatic (spring) return from START</b>								
 FS 1413890		2	20 A	T0-2-15907/IVS	076423	1	✓	X
<b>Without 0 (Off) position</b>								
 FS 19334		1	20 A	T0-1-15451/IVS	083943	1	✓	X
		2	20 A	T0-2-15452/IVS	098181	1	✓	X
		3	20 A	T0-3-15453/IVS	022246	1	✓	X
<b>60° with a white thumb grip and front plate</b>								
 F 085		1	10 A	TM-1-15431/IVS	225342	1	✓	X



022246



225342









Photos are representative

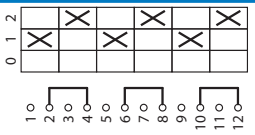

# Service distribution board mounting - Multi speed switch-disconnectors

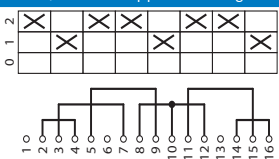
## Without emergency switch off/emergency stop function

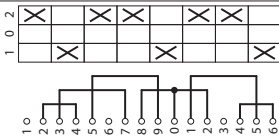
Front plate	Contact sequence	Number of poles 	Rated current	Part number	Article number	Pack qty	Suitable for export to North America (US and Canada)	Padlockable handle
<b>2 speed, non reversing, for 2 separate windings</b>								
 FS 644		6	20 A	T0-3-8451/IVS	026985	1	✓	X
<b>2 speed, 2 directions, for one tapped winding</b>								
 FS 644		3	20 A	T0-4-8440/IVS	029358	1	✓	X
 FS 684		3	20 A	T0-4-8441/IVS	031731	1	✓	X









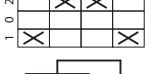
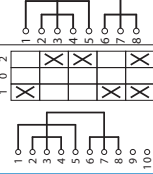
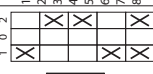
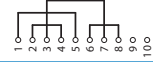

031731

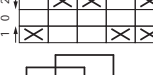
Photo is representative

# Service distribution board mounting - Reversing switch-disconnectors

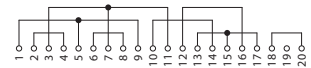
## Without emergency switch off/emergency stop function

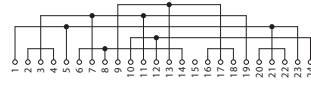
Front plate	Contact sequence	Number of poles N/O	Rated current	Part number	Article number	Pack qty	Suitable for export to North America (US and Canada)	Padlockable handle
<b>Reversing switch-disconnectors - Without Automatic (spring) return to 0 (Off) position</b>								
 FS 684	 	2	20 A	T0-2-8400/IVS	060198	1	✓	X
	 	3	20 A	T0-3-8401/IVS	098166	1	✓	X
<b>Reversing switch-disconnectors - With Automatic (spring) return from both directions to 0 (Off) position</b>								
 FS 4011	 	3	20 A	T0-3-8228/IVS	062572	1	✓	X
<b>Reversing star delta - Two-way operating direction</b>								
 FS 638	 	3	20 A	T0-5-15876/IVS	000902	1	✓	X
<b>Reversing switch-disconnectors - 2 speed, 2 directions, for one tapped winding</b>								
 FS 629	 	3	20 A	T0-6-15866/IVS	036477	1	✓	X



036477









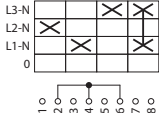
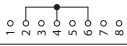

000902

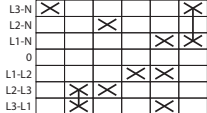
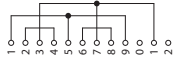
Photos are representative

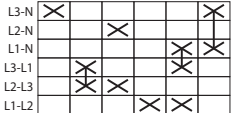
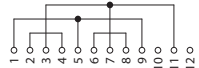
# Service distribution board mounting - Selector switch-disconnectors

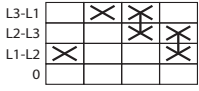
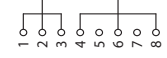
## Without emergency switch off/emergency stop function

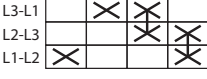
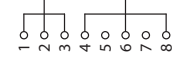
Front plate	Contact sequence	Number of poles	N/O	Rated current	Part number	Article number	Pack qty	Suitable for export to North America (US and Canada)	Padlockable handle
<b>Voltmeter</b>									
		3 x phase-N with 0 position	3+N	20 A	T0-2-15921/IVS	<a href="#">074456</a>	1	✓	X
FS 1410757									
		3 x phase-phase 3 x phase-N with 0 position	3+N	20 A	T0-3-8007/IVS	<a href="#">012759</a>	1	✓	X
FS 1410759									
		3 x phase-phase 3 x phase-N without 0 position with complete rotation in both directions	3+N	20 A	T0-3-15924/IVS	<a href="#">026997</a>	1	✓	X
FS 164721									
		3 x phase-phase with 0 position	3+N	20 A	T0-2-15920/IVS	<a href="#">029452</a>	1	✓	X
FS 1410755									
		3 x phase-phase without 0 position	3+N	20 A	T0-2-15922/IVS	<a href="#">060218</a>	1	✓	X
FS 164854									



029452

Photo is representative

# Service distribution board mounting - Star delta switch-disconnectors

## Without emergency switch off/emergency stop function

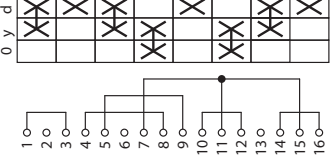
Front plate	Contact sequence	Number of poles N/O	Rated current	Part number	Article number	Pack qty	Suitable for export to North America (US and Canada)	Padlockable handle
 FS 635		3	20 A	T0-4-8410/IVS	064945	1	✓	X









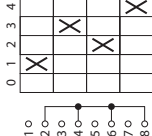

064945

Photo is representative

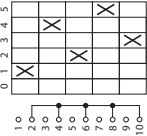
# Service distribution board mounting - Step switch-disconnectors

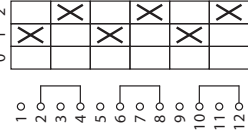
## Without emergency switch off/emergency stop function

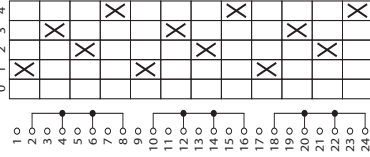
Front plate	Contact sequence	Number of poles N/O	Rated current	Part number	Article number	Pack qty	Suitable for export to North America (US and Canada)	Padlockable handle
<b>With 0 (Off) position</b>								
 FS 418		1	20 A	T0-1-8240/IVS	<a href="#">027076</a>	1	✓	X
 FS 420		1	20 A	T0-2-8241/IVS	<a href="#">057835</a>	1	✓	X
 FS 422		1	20 A	T0-2-8242/IVS	<a href="#">074446</a>	1	✓	X
 FS 424		1	20 A	T0-3-8243/IVS	<a href="#">088684</a>	1	✓	X
 FS 426		1	20 A	T0-3-8244/IVS	<a href="#">012749</a>	1	✓	X
 FS 418		3	20 A	T0-3-8280/IVS	<a href="#">041225</a>	1	✓	X
 FS 420		3	20 A	T0-5-8281/IVS	<a href="#">055463</a>	1	✓	X
 FS 422		3	20 A	T0-6-8282/IVS	<a href="#">069701</a>	1	✓	X











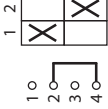

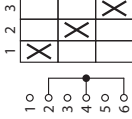

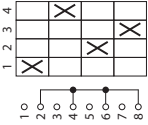

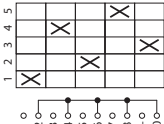

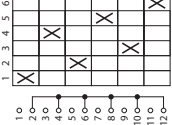
041225

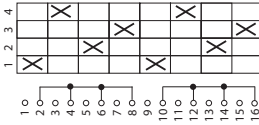
Photo is representative

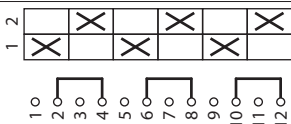
# Service distribution board mounting - Step switch-disconnectors

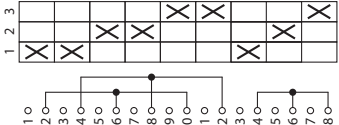
## Without emergency switch off/emergency stop function

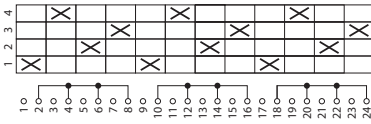
Front plate	Contact sequence	Number of poles N/O	Rated current	Part number	Article number	Pack qty	Suitable for export to North America (US and Canada)	Padlockable handle
Without 0 (Off) position								
 FS 943		1	20 A	T0-1-8220/IVS	<a href="#">055459</a>	1	✓	X
 FS 404		1	20 A	T0-2-8230/IVS	<a href="#">095804</a>	1	✓	X
 FS 606		1	20 A	T0-2-8231/IVS	<a href="#">019869</a>	1	✓	X
 FS 408		1	20 A	T0-3-8232/IVS	<a href="#">034107</a>	1	✓	X
 FS 410		1	20 A	T0-3-8233/IVS	<a href="#">048345</a>	1	✓	X
 FS 406		2	20 A	T0-3-8251/IVS	<a href="#">013974</a>	1	✓	X
 FS 943		3	20 A	T0-3-8222/IVS	<a href="#">060205</a>	1	✓	X
 FS 404		3	20 A	T0-5-8270/IVS	<a href="#">098178</a>	1	✓	X
 FS 406		3	20 A	T0-6-8271/IVS	<a href="#">022243</a>	1	✓	X



022243

Photo is representative

# Service distribution board mounting - Step switch-disconnectors for heating

## Without emergency switch off/emergency stop function

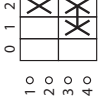
Front plate	Contact sequence	Rated current	Number of poles N/O	Part number	Article number	Pack qty	Suitable for export to North America (US and Canada)	Padlockable handle
With 0 (OFF) position								
 FS 614		20 A	1	T0-1-91/IVS	079201	1	✓	X



079201

Photo is representative

# Service distribution board mounting - Universal control switch-disconnectors

## Without emergency switch off/emergency stop function

Front plate	Contact sequence	Rated current	Part number	Article number	Pack qty	Suitable for export to North America (US and Canada)	Padlockable handle																																				
Maintained switches with 3 positions 1 Contact closed in each position - Additionally 1 contact closed in position 0 and 1 - Additionally 1 contact closed in position 0 and 2 - Additionally 1 contact closed in position 0 and 3																																											
 FS 429	<table border="1"> <tr> <td>10</td><td>20</td><td>30</td><td>40</td><td>50</td><td>60</td><td>70</td><td>80</td><td>90</td><td>100</td><td>110</td><td>120</td> </tr> <tr> <td>X</td><td>X</td><td></td><td></td><td>X</td><td></td><td></td><td></td><td>X</td><td></td><td></td><td>X</td> </tr> <tr> <td>X</td><td></td><td></td><td></td><td>X</td><td>X</td><td>X</td><td>X</td><td></td><td></td><td></td><td>X</td> </tr> </table>	10	20	30	40	50	60	70	80	90	100	110	120	X	X			X				X			X	X				X	X	X	X				X	20 A	T0-3-15391/IVS	036484	1	✓	X
10	20	30	40	50	60	70	80	90	100	110	120																																
X	X			X				X			X																																
X				X	X	X	X				X																																
Automatic (spring) return from positions 1 and 2																																											
 FS 458	<table border="1"> <tr> <td>10</td><td>20</td><td>30</td><td>40</td><td>50</td><td>60</td><td>70</td><td>80</td><td>90</td><td>100</td><td>110</td><td>120</td> </tr> <tr> <td>X</td><td>X</td><td></td><td></td><td>X</td><td></td><td></td><td></td><td>X</td><td></td><td></td><td>X</td> </tr> <tr> <td>X</td><td></td><td></td><td></td><td>X</td><td>X</td><td>X</td><td>X</td><td></td><td></td><td></td><td>X</td> </tr> </table>	10	20	30	40	50	60	70	80	90	100	110	120	X	X			X				X			X	X				X	X	X	X				X	20 A	T0-3-15394/IVS	079198	1	✓	X
10	20	30	40	50	60	70	80	90	100	110	120																																
X	X			X				X			X																																
X				X	X	X	X				X																																



079198

Photo is representative



# Service distribution board mounting dedicated accessories

## Retrofitting front plate

- For retrofitting Service distribution board mounting T0../IVS design. Use the basic switch's front plate
- Including push-in shaft

Description	Part number	Article number	Std. pack	Suitable for export to North America (US and Canada)*	Suitable for	Mounting
Service distribution board mounting accessory	IVS-T0	091114	1	✓	T0	Service distribution board /IVS



## Neutral terminal

- Early-make on switching, late-break off switching
- The N contact always behaves as an early-make contact when switching on and as a late-break contact when switching off.
- N-P1(P3)... switching capacity same as for contacts P1(P3)

Description	Part number	Article number	Std. pack	Suitable for export to North America (US and Canada)*	Suitable for	Mounting
Switched neutral	N-P1Z	000652	5	✓	P1	Service distribution board /IVS
	N-P3Z	064805	5	✓	P3	Service distribution board /IVS



000652

## Auxiliary contacts

- 1 normally open (N/O), 1 normally close contact (N/C)
- Late-break contact on switching, early-make off switching. The N/O is always connected as a load-shedding contact

Description	Part number	Article number	Std. pack	Suitable for export to North America (US and Canada)*	Suitable for	Mounting
Auxiliary contacts	H111-P1/P3Z	062031	5	✓	P1	Service distribution board /IVS
					P3-63 and P3-100	Service distribution board /IVS



062031

## Key operated lock mechanism

### For ordering with base switch unit

Part number	Article number	Key withdrawable in position
Micromec lock 90° switch angle		
+IVS/S-A	232034	0°
+IVS/S-B	232036	270°
+IVS/S-E	232040	0° + 90°
+IVS/S-F	232038	270° & 0°
+IVS/S-G	232043	270° + 0° + 90° + 180°
+IVS/S-R	232042	270° + 0° + 90°



Key operation lock mechanism, including 2 keys.

The key can only be removed in certain positions; see diagram.

The MICROMECC lock for 90° can be used for other switching angles as well if the key withdrawability characteristics match the type of switch.

Example: +IVS/S-B can be used with a step switch with a switching angle of 30° if the key is only to be withdrawable in the 0 position at 270°.

### Options for key withdrawal

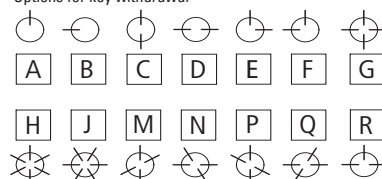

### Position marking as in example

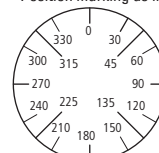

Photos are representative

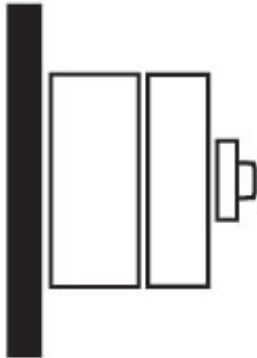

## Description

Enclosed switch-disconnectors can be installed alongside traditional panels and assemblies, or as a standalone unit for external applications (such as HVAC systems) with robust ingress protection.

## Standards/Approvals

See details page 178

## Technical data

- Voltage: 690 V a.c.
- Current: 20 A to 275 A

## Features

- Available with or without emergency switching off/emergency stop function
- Available with and without auxiliary contacts
- Available with red rotary handle and yellow locking collar and black rotary handle and locking collar
- 1-pole to 8-pole options
- Ci-K enclosed units can be optionally ordered with a North American style variant, see details page 152



P1 Switch-disconnector  
fitted in a Ci-K  
Polycarbonate enclosure

## Soft and hard knockouts

Standard Ci-K enclosure have “soft knockouts” which utilises a soft puncturable cable membrane for connection of supply and load lines while maintaining ingress protection.

Hard knockouts are also referred to as metric knockouts, and are made of a solid plastic where the central retainer is “knocked out” from the enclosure, and a metric gable gland is used to secure the ingress of supply and load lines

An option of “hard knockouts” are available for some products as a standard selection, these can be identified within the part number by the inclusion of the letter ‘H’ after the enclosure size, e.g. I1H or I2H. They can be requested, if the option is not stated in the catalogue, for enclosure sizes I1 and I2



T3 Switch-disconnector  
fitted in a steel enclosure





Parts numbers for ordering the optional hard knockouts and associated cable glands can be found on page 151.

## Enclosed switch-disconnectors - Range overview

Rated current	20 A	25 A	32 A	40 A	63 A	95 A	100 A	160 A	275 A
<b>On-Off switch-disconnectors</b>	<b>T0</b>	<b>P1</b>	<b>P1 T3</b>	<b>P1</b>	<b>P3 T5B</b>		<b>P3 T5</b>		
Without auxiliary contacts	✓	✓	✓	✓	✓	✓	✓		
With auxiliary contacts	✓	✓	✓	✓		✓		✓	
<b>Main switch-disconnectors</b>	<b>T0</b>	<b>P1</b>	<b>P1 T3</b>	<b>P1</b>	<b>P3 T5B</b>	<b>T5</b>	<b>P3 T5</b>	<b>T6</b>	<b>T8</b>
Without auxiliary contacts	✓	✓	✓	✓	✓	✓	✓		
With auxiliary contacts	✓	✓	✓	✓	✓	✓		✓	✓
<b>Changeover switch-disconnectors</b>	<b>T0</b>		<b>T3</b>		<b>T5B</b>		<b>T5</b>		
Without auxiliary contacts	✓		✓		✓		✓		
<b>Coding switch-disconnectors</b>	<b>T0</b>								
Without auxiliary contacts	✓								
<b>Heater switch-disconnectors</b>	<b>T0</b>								
Without auxiliary contacts	✓								
<b>Manual/auto switch-disconnectors</b>	<b>T0</b>								
Without auxiliary contacts	✓								
<b>Multi speed switch-disconnectors</b>	<b>T0</b>		<b>T3</b>		<b>T5B</b>				
Without auxiliary contacts	✓		✓		✓				
<b>Reversing switch-disconnectors</b>	<b>T0</b>		<b>T3</b>		<b>T5B</b>				
Without auxiliary contacts	✓		✓		✓				
<b>Safety switch-disconnectors</b>		<b>P1</b>	<b>P1</b>	<b>P1</b>	<b>P3 T5B</b>		<b>P3 T5</b>		
With auxiliary contacts		✓	✓	✓	✓	✓	✓	✓	
<b>Selector switch-disconnectors</b>	<b>T0</b>								
Without auxiliary contacts	✓								
<b>Star delta switch-disconnectors</b>	<b>T0</b>		<b>T3</b>		<b>T5B</b>				
Without auxiliary contacts	✓		✓		✓				
<b>Step switch-disconnectors</b>	<b>T0</b>								
Without auxiliary contacts	✓								
<b>Universal switch-disconnectors</b>	<b>T0</b>								
Without auxiliary contacts	✓								

# Enclosed - On-Off switch-disconnectors without auxiliary contacts

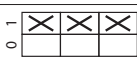
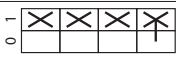
Switch-disconnector fitted in Ci-K Polycarbonate enclosure, without emergency switch off/emergency stop function

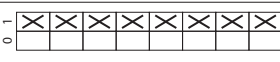
Front plate	Contact sequence	Number of poles N/O	Rated current	Part number	Article number	Pack qty	Suitable for export to North America (US and Canada)	Padlockable handle	
 FS 908		1	20 A	T0-1-8200/I1	<a href="#">207074</a>	1	X	X	
			32 A	T3-1-8200/I2	<a href="#">207167</a>	1	✓	X	
			63 A	T5B-1-8200/I4	<a href="#">207218</a>	1	✓	X	
		2	20 A	T0-1-102/I1	<a href="#">207061</a>	1	X	X	
			32 A	T3-1-102/I2	<a href="#">207165</a>	1	✓	X	
			63 A	T5B-1-102/I4	<a href="#">207215</a>	1	✓	X	
		3	20 A	T0-2-1/I1	<a href="#">207081</a>	1	X	X	
			20 A	T0-2-15403/I1	<a href="#">207088</a>	1	X	X	
			25 A	P1-25/I2	<a href="#">207299</a>	1	✓	X	
			25 A	P1-25/I2H	<a href="#">226898</a>	1	X	X	
			32 A	P1-32/I2	<a href="#">207320</a>	1	✓	X	
			32 A	P1-32/I2H	<a href="#">227866</a>	1	X	X	
			40 A	P1-40/I2	<a href="#">199906</a>	1	X	X	
			40 A	P1-40/I2H	<a href="#">199915</a>	1	X	X	
			63 A	P3-63/I4	<a href="#">207356</a>	1	✓	X	
100 A			P3-100/I5	<a href="#">207381</a>	1	✓	X		
			3 + N	20 A	T0-2-8900/I1	<a href="#">207109</a>	1	X	X
				25 A	P1-25/I2/N	<a href="#">207303</a>	1	✓	X
	25 A	P1-25/I2H/N		<a href="#">226901</a>	1	X	X		
	32 A	P1-32/I2/N		<a href="#">207324</a>	1	✓	X		
	32 A	P1-32/I2H/N		<a href="#">227869</a>	1	X	X		
	40 A	P1-40/N		<a href="#">199908</a>	1	X	X		
	40 A	P1-40/I2H/N		<a href="#">199921</a>	1	X	X		
	63 A	P3-63/I4/N		<a href="#">207360</a>	1	✓	X		
	100 A	P3-100/I5/N		<a href="#">207385</a>	1	✓	X		
		4		20 A	T0-2-1540-I1	<a href="#">207089</a>	1	X	X
	6	20 A	T0-3-8342/I1	<a href="#">207131</a>	1	X	X		
		32 A	T3-3-8342/I2	<a href="#">207187</a>	1	✓	X		
		63 A	T5B-3-8342/I4	<a href="#">207226</a>	1	✓	X		
	8	20 A	T0-4-8344/I1	<a href="#">207139</a>	1	X	X		
		32 A	T3-4-8344/I2	<a href="#">207194</a>	1	✓	X		
		63 A	T5B-3-8344/I4	<a href="#">207233</a>	1	✓	X		





226898

Photo is representative

# Enclosed - On-Off switch-disconnectors without auxiliary contacts

## Switch-disconnector fitted in steel enclosure, without emergency switch off/emergency stop function

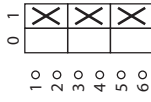
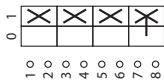
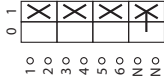
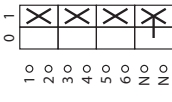
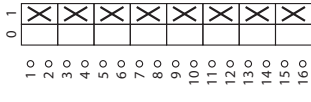
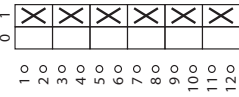
Front plate	Contact sequence	Number of poles N/O	Steel enclosures specifications		Part number	Article number	Pack qty	Padlockable handle	
			Rated current	Size					Handle colour
 FS 908		1	20 A	SE1	Black	T0-1-8200/SE1	197383	1	X
		2	20 A	SE1	Black	T0-1-102/SE1	197379	1	X
		20 A	SE1	Black	T0-2-1/SE1	197376	1	X	
		25 A	SE1	Black	P1-25/SE1	197344	1	X	
		32 A	SE1	Black	P1-32/SE1	197352	1	X	
		40 A	SE1	Black	P1-40/SE1	199944	1	X	
		63 A	SE3	Black	P3-63/SE3	197360	1	X	
	100 A	SE3	Black	P3-100/SE3	197368	1	X		
		4	20 A	SE1	Black	T0-2-8900/SE1	197420	1	X
		25 A	SE1	Black	P1-25/SE1/N	197345	1	X	
		32 A	SE1	Black	P1-32/SE1/N	197353	1	X	
		40 A	SE1	Black	P1-40/SE1/N	199945	1	X	
		63 A	SE3	Black	P3-63/SE3/N	197361	1	X	
		100 A	SE3	Black	P3-100/SE3/N	197369	1	X	
		20 A	SE1	Black	T0-3-8342/SE1	197408	1	X	
32 A		SE2	Black	T3-3-8342/SE1	197456	1	X		
	8	20 A	SE2	Black	T0-4-8344/SE2	197411	1	X	
	8	32 A	SE2	Black	T3-4-8344/SE2	197459	1	X	







197379

Photo is representative

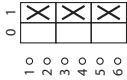
# Enclosed - On-Off switch-disconnectors without auxiliary contacts

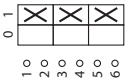
## Switch-disconnector fitted in Ci-K Polycarbonate enclosure, without emergency switch off/emergency stop function

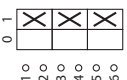





Front plate	Contact sequence	Pole N/O	Rated current	Part number	Article number	Pack qty	Suitable for export to North America (US and Canada)	Padlockable handle
Key operation lock mechanism ST-0 Key can only be withdrawn in position 0 (Pos A)								
		2	20 A	T0-1-102/11/S	207063	1	✓	X
FS 908								
With SVA Padlocking feature and two keys If the key is withdrawn in position 1 the switch can be switched off but not on again without the key Key can only be withdrawn in position 0 (Pos A)								
		3	20 A	T0-2-1/11/SVA(A)	207083	1	X	✓
		3	25 A	P1-25/12/SVA(A)	207304	1	X	✓
		3	32 A	P1-32/12/SVA(A)	207325	1	X	✓
FS 908								
Panic switch-disconnectors fitted with a SVA Cylinder lock Supplied with two keys If the key is withdrawn in position 1 the switch can be switched off but not on again without the key								
		3	20 A	T0-2-1/11/SVA(S)	207084	1	X	✓
		3	25 A	P1-25/12/SVA(S)	207305	1	X	✓
		3	32 A	P1-32/12/SVA(S)	207326	1	X	✓
FS 908								

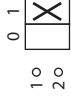
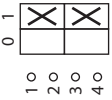

Photos are representative

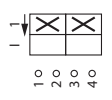
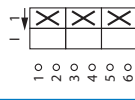
# Enclosed - On-Off switch-disconnectors without auxiliary contacts

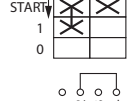
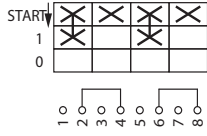
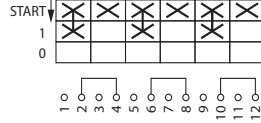
## Switch-disconnector fitted in Ci-K Polycarbonate enclosure, without emergency switch off/emergency stop function

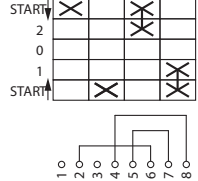
Front plate	Contact sequence	Number of poles N/O	Rated current	Part number	Article number	Pack qty	Suitable for export to North America (US and Canada)	Padlockable handle
 FS 415		1	20 A	T0-1-15401/11	<a href="#">207067</a>	1	X	X
		2	20 A	T0-1-15402/11	<a href="#">207068</a>	1	X	X
<b>With Automatic (spring) return from position 1</b>								
 FS 4721		1	20 A	T0-1-15321/11	<a href="#">207064</a>	1	✓	X
		2	20 A	T0-1-15322/11	<a href="#">207065</a>	1	✓	X
		3	20 A	T0-2-15323/11	<a href="#">207087</a>	1	✓	X
<b>With Automatic (spring) return in START position</b>								
 FS 147767		1	20 A	T0-1-15511/11	<a href="#">207073</a>	1	✓	X
		2	20 A	T0-2-15512/11	<a href="#">207093</a>	1	✓	X
		3	20 A	T0-3-15513/11	<a href="#">207117</a>	1	✓	X
 FS 140660		2	20 A	T0-2-8177/11	<a href="#">207101</a>	1	✓	X









  
207087

Photo is representative

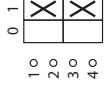
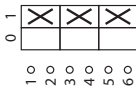
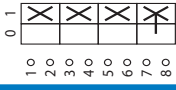
# Enclosed - On-Off switch-disconnectors without auxiliary contacts

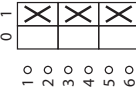
## Switch-disconnector fitted in Ci-K Polycarbonate enclosure, with emergency switch off/emergency stop function

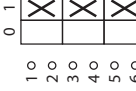
Front plate	Contact sequence	Number of poles N/O	Rated current	Part number	Article number	Pack qty	Suitable for export to North America (US and Canada)	Padlockable handle
 FS 908		1	20 A	T0-1-8200/I1-RT	207075	1	✓	X
		2	20 A	T0-1-102/I1-RT	207062	1	X	X
		32 A	T3-1-102/I2-RT	207166	1	✓	X	
		3	20 A	T0-2-1/I1-RT	207082	1	X	X
		25 A	P1-25/I2-RT	207300	1	✓	X	
		32 A	P1-32/I2-RT	207321	1	✓	X	
		40 A	P1-40/I2-RT	199930	1	X	X	
		63 A	P3-63/I4-RT	207357	1	✓	X	
		3-N	20 A	T0-2-8900/I1-RT	207110	1	✓	X
<b>Panic switch-disconnector fitted with SVC Padlocking feature</b> Supplied with two keys*								
 FS 908 GE		3	20 A	T0-2-1/I1/SVC(S)-RT	207086	1	X	✓
		3	25 A	P1-25/I2/SVC(S)-RT	207307	1	X	✓
		3	32 A	P1-32/I2/SVC(S)-RT	207328	1	X	✓
<b>Panic switch-disconnector fitted with a SVA Cylinder lock</b> Supplied with two keys								
 FS 908 GE		3	20 A	T0-2-1/I1/SVA(S)-RT	207085	1	X	✓
		3	25 A	P1-25/I2/SVA(S)-RT	207306	1	X	✓

\*Note: If the locking device is padlocked in position 1 the switch can be switched off but not on again without removing the padlock. Lockable with max 3 padlocks





Photos are representative



# Enclosed - On-Off switch-disconnectors with auxiliary contacts

## Switch-disconnector fitted in Ci-K Polycarbonate enclosure, without emergency switch off/emergency stop function

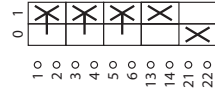
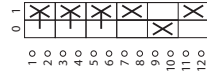
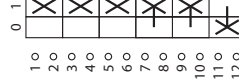
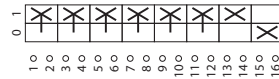
Front plate	Contact sequence	Number of poles			Auxiliary contacts			Rated current	Part number	Article number	Pack qty	Suitable for export to North America (US and Canada)	Padlockable handle
		N/O	N/O	N/C	N/O	N/O	N/C						
 FS 908		3	1	0	20 A	T0-2-15679/I1	<a href="#">207094</a>	1	X	X			
		3	1	1	25 A	P1-25-I2H/HI11	<a href="#">226899</a>	1	X	X			
	32 A				P1-32-I2H/HI11	<a href="#">227867</a>	1	X	X				
	40 A				P1-40-I2H/HI11	<a href="#">199916</a>	1	X	X				
		3	2	1	20 A	T0-3-15683/I1	<a href="#">207118</a>	1	X	X			
	32 A				T3-3-15683/I2	<a href="#">207182</a>	1	✓	X				
		3-N	1	1	20 A	T0-3-8901/I1	<a href="#">231941</a>	1	X	X			
	32 A				T3-3-8901/I2	<a href="#">231951</a>	1	✓	X				
		6	1	1	20 A	T0-4-15682/I1	<a href="#">207135</a>	1	X	X			
	32 A				T3-4-15682/I2	<a href="#">207190</a>	1	✓	X				
	63 A				T5B-4-15682/I4	<a href="#">207229</a>	1	✓	X				
	100 A				T5-4-15682/I5	<a href="#">207269</a>	1	X	X				



207190

Photo is representative

# Enclosed - On-Off switch-disconnectors with auxiliary contacts

## Switch-disconnector fitted in steel enclosure, without emergency switch off/emergency stop function

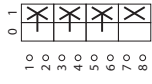
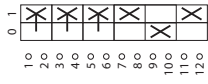
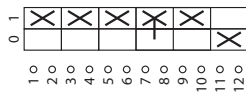
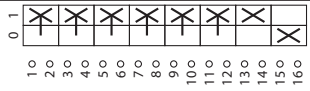
Front plate	Contact sequence	Number of poles	Auxiliary contacts			Rated current	Steel enclosures specifications			Part number	Article number	Pack qty	Padlockable handle
			N/O	N/O	N/C		Size	Handle colour					
 FS 908		3	1	0	20 A	SE1	Black	T0-2-15679/SE1	<a href="#">197440</a>	1	X		
		3	2	1	20 A	SE1	Black	T0-3-15683/SE1	<a href="#">197449</a>	1	X		
	32 A				SE2	Black	T3-3-15683/SE2	<a href="#">197475</a>	1	X			
		4	1	1	20 A	SE1	Black	T0-3-15680/SE1	<a href="#">197443</a>	1	X		
	6	1	1	20 A	SE2	Black	T0-4-15682/SE2	<a href="#">197446</a>	1	X			
32 A				SE2	Black	T3-4-15682/SE2	<a href="#">197472</a>	1	X				







197446

Photo is representative

# Enclosed - Main switch-disconnectors without auxiliary contacts

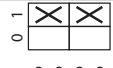
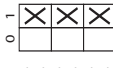
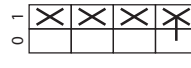
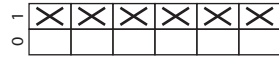
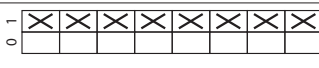
Switch-disconnector fitted in Ci-K Polycarbonate enclosure, without emergency switch off/emergency stop function

Front plate	Contact sequence	Number of poles	Rated current	Part number	Article number	Pack qty	Suitable for export to North America (US) and Canada	Padlockable handle		
 FS 908		1	20 A	T0-1-8200/I1/SVB-SW	207146	1	X	✓		
			32 A	T3-1-8200/I2/SVB-SW	207201	1	✓	✓		
			63 A	T5B-1-8200/I4/SVB-SW	207241	1	✓	✓		
		2	20 A	T0-1-102/I1/SVB-SW	207144	1	X	✓		
			32 A	T3-1-102/I2/SVB-SW	207199	1	✓	✓		
			63 A	T5B-1-102/I4/SVB-SW	207239	1	✓	✓		
				3	20 A	T0-2-1/I1/SVB-SW	207148	1	X	✓
					25 A	P1-25/I2/SVB-SW	207294	1	✓	✓
					25 A	P1-25/I2H/SVB-SW	227861	1	X	✓
		3 + N	20 A	T0-2-8900/I1/SVB-SW	207152		X	✓		
			25 A	P1-25/I2/SVB-SW/N	207296	1	✓	✓		
			25 A	P1-25/I2H/SVB-SW/N	227863	1	X	✓		
32 A			P1-32/I2/SVB-SW/N	207317	1	✓	✓			
32 A			P1-32/I2H/SVB-SW/N	227874	1	X	✓			
32 A			P1-32/I2H/N	227869	1	X	✓			
40 A			P1-40/I2/SVB-SW/N	199914	1	X	✓			
40 A			P1-40/I2H/SVB-SW/N	199927	1	X	✓			
63 A			P3-63/I4/SVB-SW/N	207346	1	✓	✓			
100 A			P3-100/I5/SVB-SW/N	207376	1	✓	✓			
			6	20 A	T0-3-8342/I1/SVB-SW	207160	1	X	✓	
				32 A	T3-3-8342/I2/SVB-SW	207209	1	✓	✓	
	63 A	T5B-3-8342/I4/SVB-SW		207243	1	✓	✓			
	100 A	T5-3-8342/I5/SVB-SW		207280	1	X	✓			
		8		20 A	T0-4-8344/I1/SVB-SW	207164	1	X	✓	
				32 A	T3-4-8344/I2/SVB-SW	207213	1	✓	✓	
	8	63 A	T5B-4-8344/I4/SVB-SW	207249	1	✓	✓			
		95 A	T5-4-8344/I5/SVB-SW	207284	1	X	✓			



207239

Photo is representative

# Enclosed - Main switch-disconnectors without auxiliary contacts

Switch-disconnectors fitted in polycarbonate Ci-K Enclosures with pre-assembled EMC screen, Without emergency switch off/emergency stop function

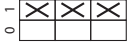
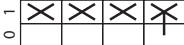
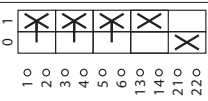
Front plate	Contact sequence	Number of poles N/O	Rated current	Part number	Article number	Padlockable handle
 FS 908	 1 0 1 0 0 1 1 0 2 0 3 0 4 0 5 0 6 0	3	20 A	T0-2-1/I2H/MBS/SVB-SW	182426	✓
			63 A	P3-63/I4/MBS/SVB-SW	182422	✓
	 1 0 1 0 0 1 1 0 2 0 3 0 4 0 5 0 6 0 7 0 8 0	3 + N	20 A	T0-2-8900/I2H/MBS/SVB-SW	182428	✓
	 1 0 1 0 0 1 1 0 2 0 3 0 4 0 5 0 6 0 13 0 14 0 21 0 22 0	3	25 A	P1-25/I2H/MBS/SVB-SW	182414	✓
			32 A	P1-32/I2H/MBS/SVB-SW	182418	✓
			40 A	P1-40/I2H/MBS/SVB-SW	199919	✓







182428

Photo is representative

# Enclosed - Main switch-disconnectors without auxiliary contacts

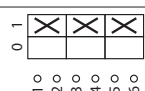
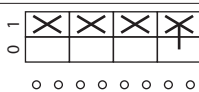
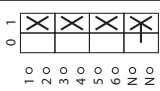
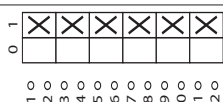
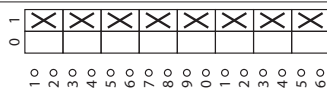
## Switch-disconnector fitted in steel enclosure, without emergency switch off/emergency stop function

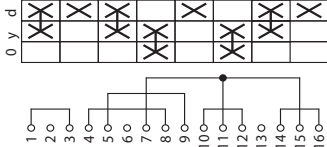
Front plate	Contact sequence	Number of poles N/O	Rated current	Steel enclosures specifications		Part number	Article number	Pack qty	Suitable for export to North America and Canada
				Size	Handle colour				
 FS 908		1	20 A	SE1	Black	T0-1-8200/SE1/SVB-SW	197385	1	X
		2	20 A	SE1	Black	T0-1-102/SE1/SVB-SW	197381	1	X
	 10 20 30 40 50 60	20 A	SE1	Black	T0-2-1/SE1/SVB-SW	197378	1	X	
		25 A	SE1	Black	P1-25/SE1/SVB-SW	197349	1	X	
		32 A	SE1	Black	P1-32/SE1/SVB-SW	197357	1	X	
		40 A	SE1	Black	P1-40/SE1/SVB-SW	199949	1	X	
		63 A	SE3	Black	P3-63/SE3/SVB-SW	197365	1	X	
	100 A	SE3	Black	P3-100/SE3/SVB-SW	197373	1	X		
	 10 20 30 40 50 60 70 80	20 A	SE1	Black	T0-2-8900/SE1/SVB-SW	197422	1	X	
									X
 10 20 30 40 50 60 N0	25 A	SE1	Black	P1-25/SE1/SVB-SW/N	197351	1	X		
	32 A	SE1	Black	P1-32/SE1/SVB-SW/N	197359	1	X		
	40 A	SE1	Black	P1-40/SE1/SVB-SW/N	199951	1	X		
	4	63 A	SE3	Black	P3-63/SE3/SVB-SW/N	197367	1	X	
		100 A	SE3	Black	P3-100/SE3/SVB-SW/N	197375	1	X	
	 10 20 30 40 50 60 70 80 90 100 110 120	20 A	SE1	Black	T0-3-8342/SE1/SVB-SW	197410	1	X	
32 A		SE2	Black	T3-3-8342/SE1/SVB-SW	197458	1	X		
 10 20 30 40 50 60 70 80 90 100 110 120 130 140 150 160	20 A	SE2	Black	T0-4-8344/SE2/SVB-SW	197413	1	X		
	32 A	SE2	Black	T3-4-8344/SE2/SVB-SW	197461	1	X		
 FS 635	 10 20 30 40 50 60 70 80 90 100 110 120 130 140 150 160	8	32 A	SE2	Black	T3-4-8344/SE2/SVB-SW	197461	1	X

Note: All the SVB-SW handles are padlockable





197422

Photo is representative

# Enclosed - Main switch-disconnectors without auxiliary contacts

## Switch-disconnectors fitted in polycarbonate Ci-K Enclosures With emergency switch off/emergency stop function

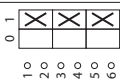
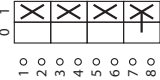
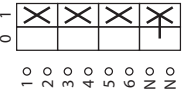
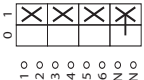
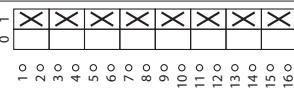
Front plate	Contact sequence	Number of poles N/O	Rated current	Part number	Article number	Pack qty	Suitable for export to North America (US) and Canada	Padlockable handle
FS 908 		1	20 A	T0-1-8200/I1/SVB	207145	1	X	✓
			32 A	T3-1-8200/I2/SVB	207200	1	✓	✓
			63 A	T5B-1-8200/I4/SVB	207240	1	✓	✓
		2	20 A	T0-1-102/I1/SVB	207143	1	X	✓
			32 A	T3-1-102/I2/SVB	207198	1	X	✓
			63 A	T5B-1-102/I4/SVB	207238	1	✓	✓
			100 A	T5-1-102/I5/SVB	207273	1	X	✓
			20 A	T0-2-1/I1/SVB	207147	1	X	✓
		3	25 A	P1-25/I2/SVB	207293	1	✓	✓
			25 A	P1-25/I2H/SVB	226900	1	X	✓
			32 A	P1-32/I2/SVB	207314	1	✓	✓
			32 A	P1-32/I2H/SVB	227868	1	✓	✓
40 A			P1-40/I2/SVB	199909	1	X	✓	
40 A			P1-40/I2H/SVB	199922	1	X	✓	
63 A			P3-63/I4/SVB	207343	1	✓	✓	
100 A			P3-100/I5/SVB	207373	1	✓	✓	
	3 + N	20 A	T0-2-8900/I1/SVB	207151	1	X	✓	
	3 + N	25 A	P1-25/I2/SVB/N	207298	1	✓	✓	
		25 A	P1-25/I2H/SVB/N	227860	1	X	✓	
		32 A	P1-32/I2/SVB/N	207319	1	✓	✓	
		32 A	P1-32/I2H/SVB/N	227871	1	X	✓	
		40 A	P1-40/I2/SVB/N	199911	1	X	✓	
		40 A	P1-40/I2H/SVB/N	199924	1	X	✓	
		63 A	P3-63/I4/SVB/N	207349	1	✓	✓	
		100 A	P3-100/I5/SVB/N	207379	1	✓	✓	
	6	20 A	T0-3-8342/I1/SVB	207159	1	X	✓	
		32 A	T3-3-8342/I2/SVB	207208	1	✓	✓	
		63 A	T5B-3-8342/I4/SVB	207242	1	✓	✓	
		100 A	T5-3-8342/I5/SVB	207279	1	X	✓	
	8	20 A	T0-4-8344/I1/SVB	207163	1	X	✓	
		32 A	T3-4-8344/I2/SVB	207212	1	✓	✓	
		63 A	T5B-4-8344/I4/SVB	207248	1	✓	✓	
		95 A	T5-4-8344/I5/SVB	207283	1	X	✓	









207283

Photo is representative

## Enclosed - Main switch-disconnectors without auxiliary contacts

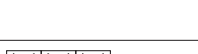
**Switch-disconnectors fitted in polycarbonate Ci-K Enclosures with pre-assembled EMC screen, With emergency switch off/ emergency stop function**

Front plate	Contact sequence	Number of poles N/O	Rated current	Part number	Article number	Pack quantity	Suitable for export to North America (US) and Canada	Padlockable handle
 FS 908	 1 2 3 0 4 5 6	3	20 A	T0-2-1/I2H/MBS/SVB	182425	1	X	✓
	 1 2 3 4 5 6 7 8	3 + N	20 A	T0-2-8900/I2H/MBS/SVB	182427	1	X	✓
	 1 2 3 4 5 6 7 8 9 10 11 12	3	25 A	P1-25/I2H/MBS/SVB	182413	1	X	✓
	 1 2 3 4 5 6 7 8 9 10 11 12		32 A	P1-32/I2H/MBS/SVB	182417	1	X	✓
	 1 2 3 4 5 6 7 8 9 10 11 12		40 A	P1-40/I2H/MBS/SVB	199917	1	X	✓
 1 2 3 0 4 5 6	3	63 A	P3-63/I4/MBS/SVB	182421	1	X	✓	





182421

Photo is representative

# Enclosed - Main switch-disconnectors without auxiliary contacts

## Switch-disconnectors fitted in steel enclosure With emergency switch off/emergency stop function

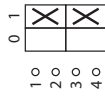
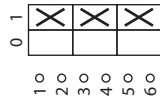
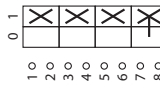
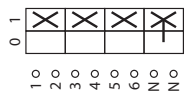
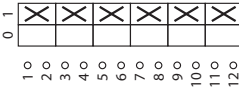
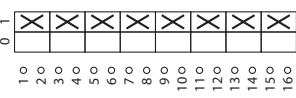
Front plate	Contact sequence	Number of poles I/O	Rated current	Steel enclosure specification Size	Handle colour	Part number	Article number	Pack qty	Suitable for export to North America (US) and Canada
 FS 908		1	20 A	SE1	Red	T0-1-8200/SE1/SVB	197384	1	X
		2	20 A	SE1	Red	T0-1-102/SE1/SVB	197380	1	X
		20 A	SE1	Red	T0-2-1/SE1/SVB	197377	1	X	
		25 A	SE1	Red	P1-25/SE1/SVB	197346	1	X	
		32 A	SE1	Red	P1-32/SE1/SVB	197354	1	X	
		40 A	SE1	Red	P1-40/SE1/SVB	199946	1	X	
		63 A	SE3	Red	P3-63/SE3/SVB	197362	1	X	
		100 A	SE3	Red	P3-100/SE3/SVB	197370	1	X	
		20 A	SE1	Red	T0-2-8900/SE1/SVB	197421	1	X	
		25 A	SE1	Red	P1-25/SE1/SVB/N	197348	1	X	
		32 A	SE1	Red	P1-32/SE1/SVB/N	197356	1	X	
		40 A	SE1	Red	P1-40//SE1/SVB/N	199948	1	X	
		4	63 A	SE3	Red	P3-63/SE3/SVB/N	197364	1	X
100 A			SE3	Red	P3-100/SE3/SVB/N	197372	1	X	
	20 A	SE1	Red	T0-3-8342-SE1/SVB	197409	1	X		
	32 A	SE2	Red	T3-3-8342/SE2/SVB	197457	1	X		
	20 A	SE2	Red	T0-4-8344/SE2/SVB	197412	1	X		
	32 A	SE2	Red	T3-4-8344/SE2/SVB	197460	1	X		

Note: All the SVB handles are padlockable







197460

Photo is representative

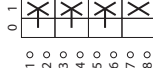

# Enclosed - Main switch-disconnectors with auxiliary contacts

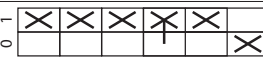
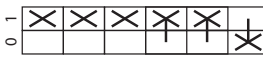
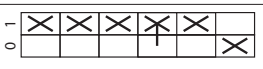
## Switch-disconnector fitted in Ci-K Polycarbonate enclosure, without emergency switch off/emergency stop function

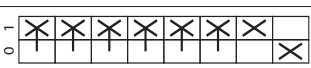
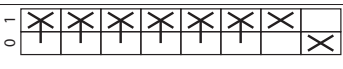
Front plate	Contact sequence	Number of poles			Auxiliary contacts			Rated current	Part number	Article number	Pack qty	Suitable for export to North America (US) and Canada
		3	1	0	N/O	N/O	N/C					
 FS 908	 1 0 1 0 0 1 1 0 2 0 3 0 4 0 5 0 6 0 7 0 8 0	3	1	0				20 A	T0-2-15679/11/SVB-SW	207150	1	X
	 1 0 1 0 0 1 1 0 2 0 3 0 4 0 5 0 6 0 13 0 14 0 21 0 22 0	3	1	1				25 A	P1-25/12/SVB-SW/Hi11	207295	1	✓
							25 A	P1-25/12H/SVB-SW/Hi11	227862	1	X	
							25 A	P1-25/12H/SVB/Hi11	226902	1	X	
							32 A	P1-32/12/SVB-SW/Hi11	207316	1	✓	
							32 A	P1-32/12H/SVB-SW/Hi11	227873	1	X	
							40 A	P1-40/12/SVB-SW/Hi11	199913	1	X	
							40 A	P1-40/12H/SVB-SW/Hi11	199926	1	X	
							63 A	P3-63/14/SVB-SW/Hi11	207345	1	✓	
							100 A	P3-100/15/SVB-SW/Hi11	207375	1	✓	
	 1 0 1 0 0 1 1 0 2 0 3 0 4 0 5 0 6 0 7 0 8 0 9 0 10 0 11 0 12 0	3	2	1				20 A	T0-3-15683/11/SVB-SW	207158	1	X
							32 A	T3-3-15683/12/SVB-SW	207207	1	✓	
	 1 0 1 0 0 1 1 0 2 0 3 0 4 0 5 0 6 0 7 0 8 0 9 0 10 0 11 0 12 0	3 + N	1	1				20 A	T0-3-15680/11/SVB-SW	207154	1	X
							32 A	T3-3-15680/12/SVB-SW	207203	1	✓	
	 1 0 1 0 0 1 1 0 2 0 3 0 4 0 5 0 6 0 7 0 8 0 9 0 10 0 11 0 12 0	3 + N	1	1				20 A	T0-3-8901/11/SVB-SW	231935	1	X
							32 A	T3-3-8901/12/SVB-SW	218988	1	✓	
							63 A	T5B-3-8901/14/SVB-SW	207245	1	✓	
							100 A	T5-3-8901/15/SVB-SW	207278	1	X	
	 1 0 1 0 0 1 1 0 2 0 3 0 4 0 5 0 6 0 N 0 N 0 13 0 14 0 21 0 22 0	3 + N	1	1				63 A	P3-63/14/SVB-SW/N/Hi11	207347	1	✓
							100 A	P3-100/15/SVB-SW/N/Hi11	207377	1	✓	
	 1 0 1 0 0 1 1 0 2 0 3 0 4 0 5 0 6 0 N 0 N 0 13 0 14 0 21 0 22 0	6	1	1				20 A	T0-4-15682/11/SVB-SW	207162	1	X
							32 A	T3-4-15682/12/SVB-SW	207211	1	✓	
							63 A	T5B-4-15682/14/SVB-SW	207247	1	✓	
							100 A	T5-4-15682/15/SVB-SW	207282	1	X	
	 1 0 1 0 0 1 1 1 0 1 1 0 1 2 0 1 2 0 1 3 0 2 1 0 2 1 0 2 1 0 2 1 0 1 3 0 1 3 0 2 1 0 1 4 0 2 1 0 1 0 1 0 2 2 0	6	1	1				160 A	T6-160-6/145/SVB-SW/Hi11*	201447	1	X
	 1 0 1 0 0 1 1 1 0 1 1 0 1 2 0 1 2 0 1 3 0 2 1 0 2 1 0 2 1 0 2 1 0 1 3 0 1 3 0 1 0 1 0 1 0 1 0 2 0	6	1	1				275 A	T8-3-8342/148/SVB-SW/Hi11*	201449	1	X

\* Enclosure without flanges with K95/1N\*BR

Note: All the SVB-SW handles are padlockable





207211

Photo is representative

# Enclosed - Main switch-disconnectors with auxiliary contacts

Switch-disconnectors fitted in polycarbonate Ci-K Enclosures with pre-assembled EMC screen, Without emergency switch off/emergency stop function

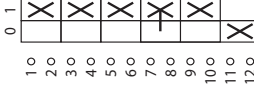
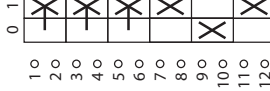
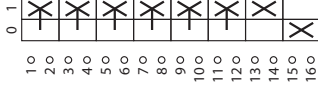
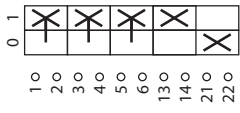
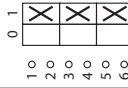
Front plate	Contact sequence	Number of poles			Rated current	Part number	Article number	Padlokable handle
		N/O	N/O	N/C				
 FS 908		1			20 A	T0-2-15679/I2H/MBS/SVB-SW	182430	✓
		1		1	20 A	T0-3-15680/I2H/MBS/SVB-SW	182432	✓
		2		1	20 A	T0-3-15683/I2H/MBS/SVB-SW	182434	✓
		1		1	20 A	T0-4-15682/I2H/MBS/SVB-SW	182436	✓
		1		1	25 A	P1-25/I2H/MBS/SVB-SW/HI11	182416	✓
					32 A	P1-32/I2H/MBS/SVB-SW/HI11	182420	✓
					40 A	P1-40/I2H/MBS/SVB-SW/HI11	199920	✓
		1		1	63 A	P3-63/I4/MBS/SVB-SW/HI11	182424	✓





182432

Photo is representative



# Enclosed - Main switch-disconnectors with auxiliary contacts

## Switch-disconnectors fitted in polycarbonate Ci-K Enclosures With emergency switch off/emergency stop function

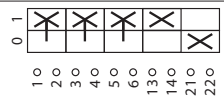
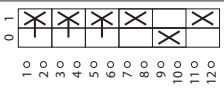
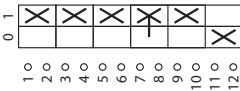
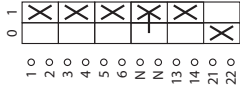
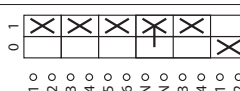
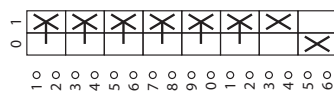
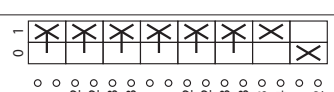
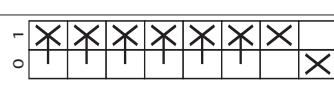
Front plate	Contact sequence	Number of poles			Auxiliary contacts			Rated current	Part number	Article number	Suitable for export to North America (US) and Canada
		N/O	N/O	N/C	N/O	N/O	N/C				
 FS 908	 1 0 1 2 3 4 5 6 7 8	3	1	0	20 A	T0-2-15679/11/SVB	207149	X			
	 1 0 1 2 3 4 5 6 7 8 13 14 21 22	3	1	1	25 A	P1-25/12/SVB/HI11	207297	✓			
					25 A	P1-25/12H/SVB/HI11	226902	X			
					32 A	P1-32/12/SVB/HI11	207318	✓			
					32 A	P1-32/12H/SVB/HI11	227870	X			
					40 A	P1-40/12/SVB/HI11	199910	X			
					40 A	P1-40/12H/SVB/HI11	199923	X			
					63 A	P3-63/14/SVB/HI11	207348	✓			
					100 A	P3-100/15/SVB/HI11	207378	✓			
	 1 0 1 2 3 4 5 6 7 8 9 10 11 12	3	2	1	20 A	T0-3-15683/11/SVB	207157	X			
					32 A	T3-3-15683/12/SVB	207206	✓			
	 1 0 1 2 3 4 5 6 7 8 9 10 11 12	3 + N	1	1	20 A	T0-3-15680/11/SVB	207153	X			
					32 A	T3-3-15680/12/SVB	207202	✓			
	 1 0 1 2 3 4 5 6 7 8 9 10 11 12 13 14 21 22	3 + N	1	1	20 A	T0-3-8901/11/SVB	231934	X			
					32 A	T3-3-8901/12/SVB	218987	✓			
					63 A	T5B-3-8901/14/SVB	207244	✓			
					100 A	T5-3-8901/15/SVB	207277	X			
	 1 0 1 2 3 4 5 6 7 8 9 10 11 12 13 14 21 22	3 + N	1	1	63 A	P3-63/14/SVB/N/HI11	207350	✓			
					100 A	P3-100/15/SVB/N/HI11	207380	✓			
	 1 0 1 2 3 4 5 6 7 8 9 10 11 12 13 14 15 16	6	1	1	20 A	T0-4-15682/11/SVB	207161	X			
					32 A	T3-4-15682/12/SVB	207210	X			
					63 A	T5B-4-15682/14/SVB	207246	✓			
					100 A	T5-4-15682/15/SVB	207281	X			
	 1 0 1L1 1T1 1L2 1T2 1L3 1T3 2L1 2T1 2L2 2T2 2L3 2T3 13 14 21 22	6	1	1	160 A	T6-160-6/145/SVB/HI11*	201448	X			
	 1 0 1L1 1T1 1L2 1T2 1L3 1T3 2L1 2T1 2L2 2T2 2L3 2T3 103 104 101 102	6	1	1	275 A	T8-3-8342/148/SVB/HI11**	201450	X			

Note: All the SVB handles are padlockable









207246

\* Enclosure without flanges with K95/1N\*BR  
 \*\* With KS4-CI and K150/1-BR; Ingress protection IP64

Photo is representative

## Enclosed - Main switch-disconnectors with auxiliary contacts

Switch-disconnectors fitted in polycarbonate Ci-K Enclosures with pre-assembled EMC screen, With emergency switch off/emergency stop function

Front plate	Contact sequence	Number of poles			Auxiliary contacts			Rated current	Part number	Article number	Pack quantity	Suitable for export to North America (US) and Canada
		N/O	N/O	N/C	N/O	N/O	N/C					
 FS 908	 1 0 1 0 1 1 0 2 0 3 0 4 0 5 0 6 0 7 0 8 0	3	1					20 A	T0-2-15679/I2H/MBS/SVB	182429	1	X
	 1 0 1 0 1 1 0 2 0 3 0 4 0 5 0 6 0 7 0 8 0 9 0 10 0 11 0 12 0	3 + N	1	1				20 A	T0-3-15680/I2H/MBS/SVB	182431	1	X
	 1 0 1 0 1 1 0 2 0 3 0 4 0 5 0 6 0 7 0 8 0 9 0 10 0 11 0 12 0	3	2	1				20 A	T0-3-15683/I2H/MBS/SVB	182433	1	X
	 1 0 1 0 1 1 0 2 0 3 0 4 0 5 0 6 0 7 0 8 0 9 0 10 0 11 0 12 0 13 0 14 0 15 0 16 0	6	1	1				20 A	T0-4-15682/I2H/MBS/SVB	182435	1	X
	 1 0 1 0 1 1 0 2 0 3 0 4 0 5 0 6 0 13 0 14 0 21 0 22 0	3	1	1				25 A	P1-25/I2H/MBS/SVB/HI11	182415	1	X
							32 A	P1-32/I2H/MBS/SVB/HI11	182419	1	X	
							40 A	P1-40/I2H/MBS/SVB/HI11	199918	1	X	
							63 A	P3-63/I4/MBS/SVB/HI11	182423	1	X	

Note: All the SVB handles are padlockable







182419

Photo is representative

# Enclosed - Main switch-disconnectors with auxiliary contacts

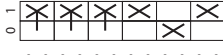
## Switch-disconnectors fitted in steel enclosure With emergency switch off/emergency stop function

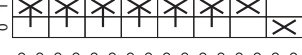
Front plate	Contact sequence	Number of poles			Auxiliary contacts			Rated current	Part number	Article number	Pack qty	Suitable for export to North America (US) and Canada	Padlockable handle
		N/O	N/O	N/C	N/O	N/O	N/C						
 FS 908	 1 0 1 2 0 2 3 0 3 4 0 4 5 0 5 6 0 6 7 0 7 8 0 8	3	1	0	20 A	T0-2-15679/SE1/SVB	197441	1	X	✓			
	 1 0 1 2 0 2 3 0 3 4 0 4 5 0 5 6 0 6 7 0 7 8 0 8 9 0 9 10 0 10 11 0 11 12 0 12	3	1	1	25 A	P1-25/SE1/SVB/HI11	197347	1	X	✓			
					32 A	P1-32/SE1/SVB/HI11	197355	1	X	✓			
					40 A	P1-40/SE1/SVB/HI11	199947	1	X	✓			
					63 A	P3-63/SE1/SVB/HI11	197363	1	X	✓			
	 1 0 1 2 0 2 3 0 3 4 0 4 5 0 5 6 0 6 7 0 7 8 0 8 9 0 9 10 0 10 11 0 11 12 0 12	3	2	1	20 A	T0-3-15683/SE1/SVB	197450	1	X	✓			
				32 A	T3-3-15683/SE2/SVB	197476	1	X	✓				
	 1 0 1 2 0 2 3 0 3 4 0 4 5 0 5 6 0 6 7 0 7 8 0 8 9 0 9 10 0 10 11 0 11 12 0 12	4	1	0	20 A	T0-3-15680/SE1/SVB	197444	1	X	✓			
	 1 0 1 2 0 2 3 0 3 4 0 4 5 0 5 6 0 6 7 0 7 8 0 8 9 0 9 10 0 10 11 0 11 12 0 12 13 0 13 14 0 14 15 0 15 16 0 16	6	1	1	20 A	T0-4-15682/SE2/SVB	197447	1	X	✓			
				32 A	T3-4-15682/SE2-SVB	197473	1	X	✓				











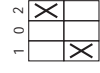

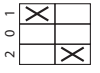

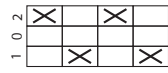



197355

Photo is representative

# Enclosed - Changeover switch-disconnectors

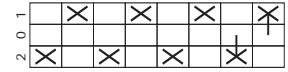
## Switch-disconnectors fitted in polycarbonate Ci-K Enclosures Without emergency switch off/emergency stop function

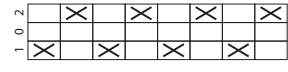
Front plate	Contact sequence	Number of poles N/O	Rated current	Part number	Article number	Pack qty	Suitable for export to North America (US and Canada)	Padlockable handle
 FS 684		1	20 A	T0-1-8210/I1	<a href="#">207076</a>	1	X	X
			32 A	T3-1-8210/I2	<a href="#">207169</a>	1	✓	X
			63 A	T5B-1-8210/I4	<a href="#">207432</a>	1	✓	X
 FS 429		1	20 A	T0-1-15421/I1	<a href="#">207069</a>	1	✓	X
			63 A	T5B-1-15421/I4	<a href="#">207069</a>	1	✓	X
 FS 684		2	20 A	T0-2-8211/I1	<a href="#">207102</a>	1	X	X
			32 A	T3-2-8211/I2	<a href="#">207178</a>	1	✓	X
			63 A	T5B-2-8211/I4	<a href="#">207220</a>	1	✓	X
 FS 429		2	20 A	T0-2-15422/I1	<a href="#">207090</a>	1	✓	X
			63 A	T5B-2-15422/I4	<a href="#">207090</a>	1	✓	X
 FS 684		3	20 A	T0-3-8212/I1	<a href="#">207123</a>	1	X	X
			32 A	T3-3-8212/I2	<a href="#">207183</a>	1	✓	X
			63 A	T5B-3-8212/I4	<a href="#">207223</a>	1	✓	X
			100 A	T5-3-8212/I5	<a href="#">207266</a>	1	X	X
 FS 429		3	20 A	T0-3-15423/I1	<a href="#">207114</a>	1	✓	X
			63 A	T5B-3-15423/I4	<a href="#">207114</a>	1	✓	X
 FS 161629		4	32 A	T3-4-8902/I2	<a href="#">215224</a>	1	✓	X
			63 A	T5B-4-8902/I4	<a href="#">207237</a>	1	✓	X
			100 A	T5-4-8902/I5	<a href="#">207214</a>	1	X	X
 FS 429		4	20 A	T0-4-8213/I1	<a href="#">207136</a>	1	✓	X
			32 A	T3-4-8213/I2	<a href="#">207191</a>	1	✓	X
			63 A	T5B-4-8213/I4	<a href="#">207230</a>	1	✓	X
			100 A	T5-4-8213/I5	<a href="#">207270</a>	1	X	X
 FS 953		4	20 A	T0-4-8294/I1	<a href="#">207138</a>	1	X	X
			32 A	T3-4-8294/I2	<a href="#">207193</a>	1	✓	X
			63 A	T5B-4-8294/I4	<a href="#">207232</a>	1	✓	X
			100 A	T5-4-8294/I5	<a href="#">207433</a>	1	X	X









207232

Photo is representative

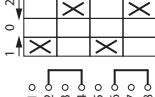
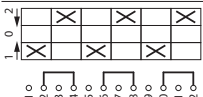
# Enclosed - Changeover switch-disconnectors

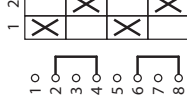
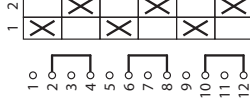
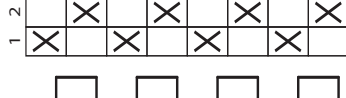
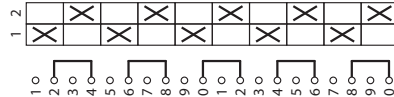
## Switch-disconnectors fitted in polycarbonate Ci-K Enclosures Without emergency switch off/emergency stop function

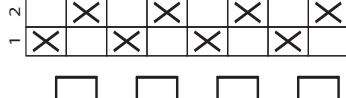
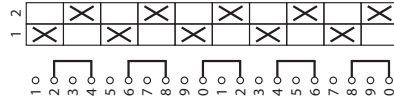
Front plate	Contact sequence	Number of poles N/O	Rated current	Part number	Article number	Pack qty	Suitable for export to North America (US and Canada)	Padlockable handle
<b>With Automatic (spring) return to the O (OFF) position from both directions</b>								
 FS 4011		1	20 A	T0-1-8214/I1	<a href="#">207077</a>	1	✓	X
		2	20 A	T0-2-8215/I1	<a href="#">207103</a>	1	✓	X
		32 A	T3-2-8215/I2	<a href="#">207179</a>	1	✓	X	
		3	20 A	T0-3-8216/I1	<a href="#">207434</a>	1	✓	X
		32 A	T3-3-8216/I2	<a href="#">207184</a>	1	✓	X	
	<b>Two way switch-disconnector</b>							
 FS 943		1	20 A	T0-1-8220/I1	<a href="#">207078</a>	1	X	X
		2	20 A	T0-2-8221/I1	<a href="#">207104</a>	1	X	X
		32 A	T3-2-8221/I2	<a href="#">207180</a>	1	✓	X	
		3	20 A	T0-3-8220/I1	<a href="#">207124</a>	1	X	X
			32 A	T3-3-8222/I2	<a href="#">207185</a>	1	✓	X
		4	20 A	T0-4-8223/I1	<a href="#">207137</a>	1	X	X
			32 A	T3-4-8223/I2	<a href="#">207192</a>	1	✓	X
		5	32 A	T3-5-8369/I2	<a href="#">207536</a>	1	✓	X
			63 A	T5B-2-8221/I4	<a href="#">207221</a>	1	✓	X
		5	32 A	T3-3-8222/I2	<a href="#">207185</a>	1	✓	X
63 A			T5B-3-8222/I4	<a href="#">207224</a>	1	✓	X	
	4	20 A	T0-4-8223/I1	<a href="#">207137</a>	1	X	X	
		32 A	T3-4-8223/I2	<a href="#">207192</a>	1	✓	X	
	5	32 A	T3-5-8369/I2	<a href="#">207536</a>	1	✓	X	
		63 A	T5B-3-8223/I4	<a href="#">207231</a>	1	✓	X	







207137

Photo is representative

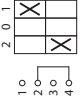
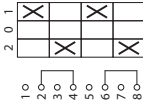
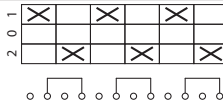
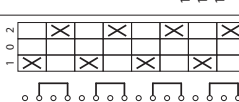

# Enclosed - Changeover switch-disconnectors

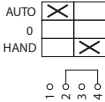
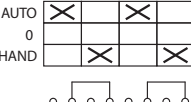
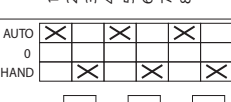
## Switch-disconnectors fitted in steel enclosure Without emergency switch off/emergency stop function

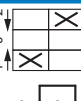
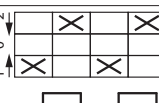
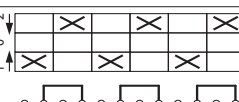
Front plate	Contact sequence	Number of poles N/O	Rated current	Steel enclosures specifications		Part number	Article number	Pack qty	Suitable for export to North America and Canada	Padlockable handle
				Size	Handle colour					
<b>With 0 (OFF) position</b>										
 FS 684		1	20 A	SE1	Black	T0-1-8210/SE1	197386	1	X	✓
		2	20 A	SE1	Black	T0-2-8211/SE1	197387	1	X	✓
		3	20 A	SE1	Black	T0-3-8212/SE1	197388	1	X	✓
		4	20 A	SE2	Black	T0-4-8213/SE2	197389	1	X	✓
 FS 1401		1	20 A	SE1	Black	T0-1-15431/SE1	197430	1	X	✓
		2	20 A	SE1	Black	T0-2-15432/SE1	197431	1	X	✓
		3	20 A	SE1	Black	T0-3-15433/SE1	197432	1	X	✓
<b>With Automatic (spring) return to the 0 (OFF) position from both directions</b>										
 FS 4011		1	20 A	SE1	Black	T0-1-8214/SE1	197390	1	X	✓
		2	20 A	SE1	Black	T0-2-8215/SE1	197391	1	X	✓
		3	20 A	SE1	Black	T0-3-8216/SE1	197392	1	X	✓





197389

Photo is representative

# Enclosed - Changeover switch-disconnectors

## Switch-disconnectors fitted in steel enclosure Without emergency switch off/emergency stop function

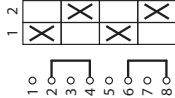
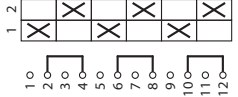
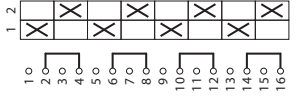
Front plate	Contact sequence	Number of poles N/O	Rated current	Steel enclosures specifications		Part number	Article number	Pack qty	Suitable for North America and Canada	Padlockable handle
				Size	Handle colour					
Two way switch-disconnector without 0 (OFF) position										
 FS 943		1	20 A	SE1	Black	T0-1-8220/SE1	<a href="#">197393</a>	1	X	X
		2	20 A	SE1	Black	T0-2-8221/SE1	<a href="#">197394</a>	1	X	X
		3	20 A	SE1	Black	T0-3-8222/SE1	<a href="#">197395</a>	1	X	X
		4	20 A	SE2	Black	T0-3-8223/SE2	<a href="#">197396</a>	1	X	X



197396

Photo is representative

# Enclosed - Coding switch-disconnectors

## Switch-disconnectors fitted in polycarbonate Ci-K Enclosure, without emergency switch off/emergency stop function

Front plate	Contact sequence	Rated current	Part number	Article number	Pack qty	Suitable for export to North America (US and Canada)	Padlockable handle
With complete rotation in both directions - Binary BCD Code							
<p>FS 312</p>		20 A	T0-4-15602/11	207134	1	✓	X















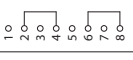
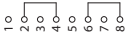

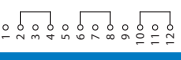
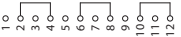





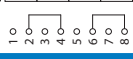
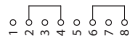

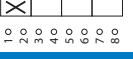
207134

Photo is representative

# Enclosed - Manual/auto switch-disconnectors

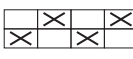
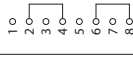
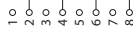
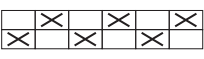
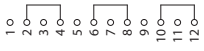
## Switch-disconnectors fitted in polycarbonate Ci-K Enclosure, without emergency switch off/emergency stop function

Front plate	Contact sequence	Number of poles N/O	Rated current	Part number	Article number	Pack qty	Suitable for export to North America (US and Canada)	Padlockable handle
<b>With 0 (Off) position</b>								
	AUTO  HAND 	1	20 A	T0-1-15431/I1	207070	1	✓	X
FS 1401								
	AUTO  HAND 	2	20 A	T0-2-15432/I1	207091	1	✓	X
								
	AUTO  HAND 	3	20 A	T0-3-15433/I1	207115	1	✓	X
								
<b>With Automatic (spring) return from HAND</b>								
	AUTO  HAND 	1	20 A	T0-1-15434/I1	207071	1	✓	X
FS 1414000								
	AUTO  HAND 	2	20 A	T0-2-15435/I1	218971	1	✓	X
								
<b>With Automatic (spring) return from START</b>								
	START  HAND  0 AUTO 	2	20 A	T0-2-15907/I1	207095	1	✓	X
FS 1413890								
<b>Without 0 (Off) position</b>								
	AUTO  HAND 	1	20 A	T0-1-15451/I1	207072	1	✓	X
FS 19334								
	AUTO  HAND 	2	20 A	T0-2-15452/I1	207092	1	✓	X
								
	AUTO  HAND 	3	20 A	T0-3-15453/I1	207116	1	✓	X
								







207071

Photo is representative

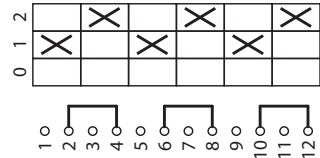
# Enclosed - Multi speed switch-disconnectors

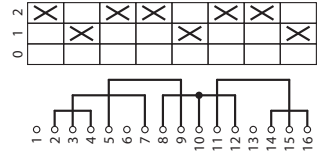
## Switch-disconnectors fitted in polycarbonate Ci-K Enclosure, without emergency switch off/emergency stop function

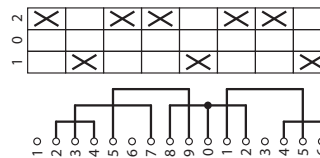
Front plate	Contact sequence	Number of poles N/O	Rated current	Part number	Article number	Pack qty	Suitable for export to North America (US and Canada)	Padlockable handle
<b>2 speed, non reversing, for 2 separate windings</b>								
 FS 644		6	20 A	T0-3-8451/11	207133	1	X	X
			32 A	T3-3-8451/12	207189	1	✓	X
			63 A	T5B-3-8451/14	207228	1	✓	X
<b>2 speed, 2 directions, for one tapped winding</b>								
 FS 644		3	20 A	T0-4-8440/11	207141	1	X	X
			32 A	T3-4-8440/12	207196	1	✓	X
			63 A	T5B-4-8440/14	207235	1	✓	X
 FS 684		3	20 A	T0-4-8441/11	207142	1	X	X
			32 A	T3-4-8441/12	207197	1	✓	X
			63 A	T5B-4-8441/14	207236	1	✓	X







207133

Photo is representative

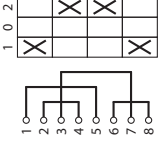
# Enclosed - Reversing switch-disconnectors

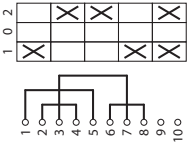
Switch-disconnectors fitted in polycarbonate Ci-K Enclosure, without emergency switch off/emergency stop function

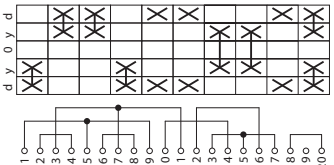
Front plate	Contact sequence	Number of poles	Rated current	Part number	Article number	Pack qty	Suitable for export to North America (US and Canada)	Padlockable handle
<b>Reversing switch-disconnector - Without Automatic (spring) return to 0 (Off) position</b>								
 FS 684		2	20 A	T0-2-8400/I1	<a href="#">207111</a>	1	✓	X
			32 A	T3-2-8400/I2	<a href="#">207181</a>	1	✓	X
			63 A	T5B-2-8400/I4	<a href="#">207222</a>	1	✓	X
 FS 4011		3	20 A	T0-3-8401/I1	<a href="#">207132</a>	1	✓	X
			32 A	T3-3-8401/I2	<a href="#">207188</a>	1	✓	X
			63 A	T5B-3-8401/I4	<a href="#">207227</a>	1	✓	X
			20 A	T0-3-8228/I1	<a href="#">207125</a>	1	✓	X
			32 A	T3-3-8228/I2	<a href="#">207186</a>	1	✓	X
			63 A	T5B-3-8228/I4	<a href="#">207225</a>	1	✓	X
<b>Reversing stat-delta switch-disconnector - Two-way operating direction</b>								
 FS 638		3	32 A	T3-5-15876/I2	<a href="#">207537</a>	1	✓	X







207225

Photo is representative

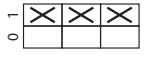
# Enclosed - Safety switch-disconnectors with auxiliary contacts

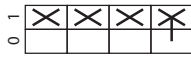
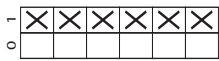
## Switch-disconnectors fitted in polycarbonate Ci-K Enclosure, without emergency switch off/emergency stop function

Front plate	Contact sequence	Number of poles	Auxiliary contacts		Rated current	Part number	Article number	Pack qty	Suitable for export to North America (US and Canada)
			N/O	N/C					
 F5 908	 1 0 2 0 3 0 4 0 5 0 6 0	3	0	0	25 A	P1-25/I2-SI-SW	<a href="#">207309</a>	1	X
					32 A	P1-32/I2-SI-SW	<a href="#">207330</a>	1	X
					63 A	P3-63/I4-SI-SW	<a href="#">207362</a>	1	X
					100 A	P3-100/I5-SI-SW	<a href="#">207387</a>	1	X
	 1 0 2 0 3 0 4 0 5 0 6 0 13 0 14 0 21 0 22 0	3	1	1	25 A	P1-25/I2-SI/HI11-SW	<a href="#">207311</a>	1	X
					32 A	P1-32/I2-SI/HI11-SW	<a href="#">207332</a>	1	X
					63 A	P3-63/I4-SI/HI11-SW	<a href="#">207364</a>	1	X
					100 A	P3-100/I5-SI/HI11-SW	<a href="#">207389</a>	1	X
	 1 0 2 0 3 0 4 0 5 0 6 0 N 0 N 0	3+N	0	1	25 A	P1-25/I2-SI/N-SW	<a href="#">207313</a>	1	X
					32 A	P1-32/I2-SI/N-SW	<a href="#">207334</a>	1	X
				63 A	P3-63/I4-SI/N-SW	<a href="#">207366</a>	1	X	
				100 A	P3-100/I5-SI/N-SW	<a href="#">207391</a>	1	X	
 1 0 2 0 3 0 4 0 5 0 6 0 7 0 8 0 9 0 10 0 11 0 12 0	6	0	0	63 A	T5B-3-8342/I4-SI-SW	<a href="#">207251</a>	1	X	
				100 A	T5-3-8342/I5-SI-SW	<a href="#">207448</a>	1	X	
 1 0 2 0 3 0 4 0 5 0 6 0 7 0 8 0 9 0 10 0 11 0 12 0 13 0 14 0 15 0 16 0	6	1	1	63 A	T5B-4-15682/I4-SI-SW	<a href="#">207255</a>	1	X	
				100 A	T5-4-15682/I5-SI-SW	<a href="#">207286</a>	1	X	
 1 0 2 0 3 0 4 0 5 0 6 0 8 0 9 0 10 0 11 0 12 0 13 0 14 0 15 0 16 0	6	2	0	63 A	T5B-4-8903/I4-SI-SW	<a href="#">207259</a>	1	X	
				100 A	T5-4-8903/I5-SI-SW	<a href="#">207290</a>	1	X	

Note: All the SI handles are padlockable

See further details about the safety switch-disconnectors page 145



Photo is representative

# Enclosed - Safety switch-disconnectors with auxiliary contacts

## Switch-disconnectors fitted in polycarbonate Ci-K Enclosure, with emergency switch off/emergency stop function

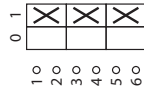
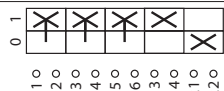
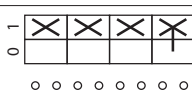
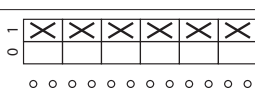
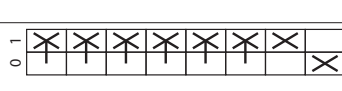
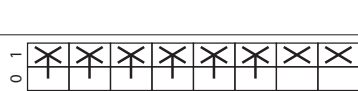
Front plate	Contact sequence	Number of poles	Auxiliary contacts		Rated current	Part number	Article number	Pack qty	Suitable for export to North America (US and Canada)	
			N/O	N/C						
 FS 908	 1 0 1 0 1 1 0 2 0 3 0 4 0 5 0 6 0	3	0	0	25 A	P1-25/I2-SI	<a href="#">207313</a>	1	X	
					32 A	P1-32/I2-SI	<a href="#">207329</a>	1	X	
					63 A	P3-63/I4-SI	<a href="#">207361</a>	1	X	
					100 A	P3-100/I5-SI	<a href="#">207386</a>	1	X	
		 1 0 1 0 1 1 0 2 0 3 0 4 0 5 0 6 0 13 0 14 0 21 0 22 0	3	1	1	25 A	P1-25/I2-SI/HI11	<a href="#">207310</a>	1	X
					32 A	P1-32/I2-SI/HI11	<a href="#">207331</a>	1	X	
					63 A	P3-63/I4-SI/HI11	<a href="#">207363</a>	1	X	
					100 A	P3-100/I5-SI/HI11	<a href="#">207388</a>	1	X	
		 1 0 1 0 1 1 0 2 0 3 0 4 0 5 0 6 0 N 0 N 0	3+N	0	1	25 A	P1-25/I2-SI/N	<a href="#">207312</a>	1	X
					32 A	P1-32/I2-SI/N	<a href="#">207333</a>	1	X	
					63 A	P3-63/I4-SI/N	<a href="#">207365</a>	1	X	
					100 A	P3-100/I5-SI/N	<a href="#">207390</a>	1	X	
	 1 0 1 0 1 1 0 2 0 3 0 4 0 5 0 6 0 7 0 8 0 9 0 10 0 11 0 12 0	6	0	0	63 A	T5B-3-8342/I4-SI	<a href="#">207250</a>	1	X	
				100 A	T5-3-8342/I5-SI	<a href="#">207447</a>	1	X		
	 1 0 1 0 1 1 0 2 0 3 0 4 0 5 0 6 0 7 0 8 0 9 0 10 0 11 0 12 0 13 0 14 0 15 0 16 0	6	1	1	63 A	T5B-4-15682/I4-SI	<a href="#">207254</a>	1	X	
				100 A	T5-4-15682/I5-SI	<a href="#">207285</a>	1	X		
	 1 0 1 0 1 1 0 2 0 3 0 4 0 5 0 6 0 7 0 8 0 9 0 10 0 11 0 12 0 13 0 14 0 15 0 16 0	6	2	0	63 A	T5B-4-8903/I4-SI	<a href="#">207258</a>	1	X	
				100 A	T5-4-8903/I5-SI	<a href="#">207289</a>	1	X		

Note: All the SI handles are padlockable

See further details about the safety switch-disconnectors page 145



Photo is representative



# Enclosed - Safety switch-disconnectors

Notes:

## Engineering:

Maintenance, repair and safety switches all have the same electrical function. They are designed to safely isolate electrical installations (loads) from mains power during maintenance and repair work and to ensure that a hazard does not arise which endangers personnel, machinery and production materials. A safety switch is an additional enclosed main switch = isolator dedicated to an individual electrical load and mounted in the immediate vicinity of the motor of the electrical load. This is particularly important is there is any danger of the main switch being inadvertently operated.

## Application

By using up to 3 padlocks, each fitter/electrician involved can protect themselves by preventing unauthorised personnel from switching the unit on. Maintenance/manual override switches are simply additional enclosed main switches with a padlocking feature. Enclosed main switch with padlocking facility.

## Features

- Safety switches are always housed in insulated enclosures and have an inscription saying 'Safety switches' on a bright orange label.
- Switches to be used in emergency stop switching have a red handle and yellow locking collar in accordance with STOP category 0 (as per IEC/EN 60204/VDE 0113).
- If the switch is not approved for emergency stop switch, both parts will be black ('SW' part no. suffix).
- The cover and handle are interlocked by fitting a padlock.

## Selection

The switches must be selected according to the following performance specifications:

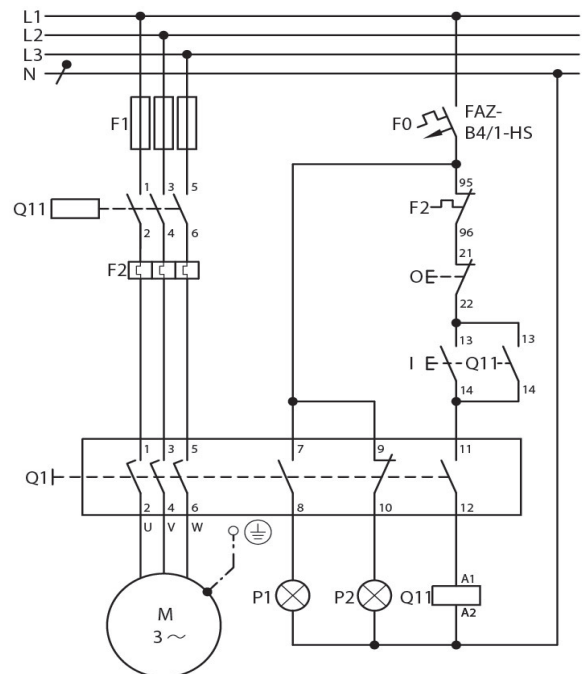

- 1) According to motor switching capacity, when the switch is fitted in such a way that the operator may use it for operational ON and OFF switching
- 2) The rating data always applies to 3 poles. When the motor rating is divided between 6 poles, such as for star-delta switching, a 6 pole switch can be used to control 1.73 time the rated power.
- 3) If the switch has a load shedding Contact (LA), you can select the appropriate switch according to the uninterrupted current. The load switching contact is an auxiliary contact, which closed in the ON position and opens early when switching off, so that a contactor located in the circuit takes over the switching duty and the maintenance/safety switch operates at zero load. When switching on, the load-shedding contact closes later than or at the same time as the main contacts. With P and T switches this is the N/O auxiliary contact.
- 4) The 'ON' position can be locked with a padlock (by altering the handle). This is not permissible for switches with a red/yellow handle.

## Safety switches with load shedding and signaling

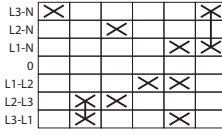

# Enclosed - Selector switch-disconnectors

Switch-disconnectors fitted in polycarbonate Ci-K Enclosure, without emergency switch off/emergency stop function

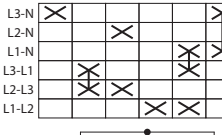
Front plate	Contact sequence	Number of poles	Rated current	Part number	Article number	Pack qty	Suitable for export to North America (US and Canada)	Padlockable handle
<b>Voltmeter switch-disconnector</b>								
 FS 1410759		3 x phase-phase 3 x phase-N with 0 position	20 A	T0-3-8007/11	207120	1	✓	X
 FS 164721		3 x phase-phase 3 x phase-N without 0 position with complete rotation in both directions	20 A	T0-3-15924/11	207119	1	✓	X





207120

Photo is representative

# Enclosed - Star delta switch-disconnectors

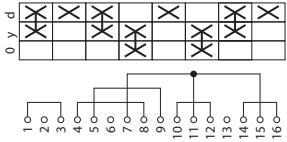
Switch-disconnectors fitted in polycarbonate Ci-K Enclosure, without emergency switch off/emergency stop function

Front plate	Contact sequence	Number of poles	Rated current	Part number	Article number	Pack qty	Suitable for export to North America (US and Canada)	Padlockable handle
 FS 635		3 	20 A	T0-4-8410/11	<a href="#">207140</a>	1	X	X
			32 A	T3-4-8410/12	<a href="#">207195</a>	1	✓	X
			63 A	T5B-4-8410/14	<a href="#">207234</a>	1	✓	X



207140

Photo is representative

# Enclosed - Step switch-disconnectors

## Switch-disconnectors fitted in polycarbonate Ci-K Enclosure, without emergency switch off/emergency stop function

Front plate	Contact sequence	Number of poles N/O	Rated current	Part number	Article number	Pack qty	Suitable for export to North America (US and Canada)	Padlockable handle
<b>With O (Off) position</b>								
FS 418		1	20 A	T0-1-8240/11	207079	1	✓	X
FS 420		1	20 A	T0-2-8241/11	207107	1	✓	X
FS 422		1	20 A	T0-2-8242/11	207108	1	✓	X
FS 424		1	20 A	T0-3-8243/11	207128	1	✓	X
FS 426		1	20 A	T0-3-8244/11	207129	1	✓	X
FS 418		3	20 A	T0-3-8280/11	207130	1	✓	X
<b>Without O (Off) position</b>								
FS 943		1	20 A	T0-1-8220/11	207078	1	✓	X
FS 404		1	20 A	T0-2-8230/11	207105	1	✓	X
FS 606		1	20 A	T0-2-8231/11	207106	1	✓	X
FS 408		1	20 A	T0-3-8232/11	207126	1	✓	X
FS 410		1	20 A	T0-3-8233/11	207127	1	✓	X
FS 406		2	20 A	T0-4-8251/11	218984	1	✓	X
FS 943		3	20 A	T0-3-8222/11	207124	1	✓	X



207105

Photo is representative

# Enclosed - Step switch-disconnectors for heating

Switch-disconnectors fitted in polycarbonate Ci-K Enclosure, without emergency switch off/emergency stop function

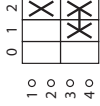
Front plate	Contact sequence	Rated current	Number of poles N/O	Part number	Article number	Pack qty	Suitable for export to North America (US and Canada)	Padlockable handle
With 0 (Off) position heater switches								
 FS 614		20 A	1	T0-1-91/I1	207080	1	✓	X



  
 207080

Photo is representative

# Enclosed - Universal control switch-disconnectors

## Switch-disconnectors fitted in polycarbonate Ci-K Enclosure, without emergency switch off/emergency stop function

Front plate	Contact sequence	Rated current	Part number	Article number	Pack qty	Suitable for export to North America (US and Canada)	Padlockable handle
<b>Maintained switches with 3 positions</b> 1 Contact closed in each position - Additionally 1 contact closed in position 0 and 1 - Additionally 1 contact closed in position 0 and 2 - Additionally 1 contact closed in position 0 and 3							
 FS 429		20 A	T0-3-15391/I1	207112	1	✓	X
<b>Automatic (spring) return from positions 1 and 2</b>							
 FS 458		20 A	T0-3-15394/I1	207113	1	✓	X



207113

Photo is representative

# Enclosed switch-disconnectors dedicated accessories

## IP65 Insulated enclosures

Description	Number of contact units	Part number	Article number	Std. pack	Suitable for export to North America (US and Canada)	Suitable for	Mounting
IP65 insulated enclosure - With metric knockouts (hard knockouts)	Only available together with basic unit	+I1H	105870	1	X	T0	Surface mounting I1
		+I2H	105871	1	X	T3	Surface mounting I2
					X	P1	Surface mounting I2



105870/ 105871

## Cable glands

Description	Part number	Article number	Std. pack	Suitable for export to North America (US and Canada)	Suitable for	Mounting
Cable gland for metric knockouts (hard knockouts)	V-M25	206911	1	X	T0	Surface mounting I1 and I2
	KT-M25	207603	1	X	T3	Surface mounting I1 and I2
				X	P1	Surface mounting I1 and I2



206911



207603

## Neutral terminals

Description	Flex cable	Suitable for	Part number	Article number	Std. pack
For connection of a 5 <sup>th</sup> conductor	1-4 mm <sup>2</sup>	CI-K1, CI-K2	K-CI-K1/2	207451	20
	1.5-16 mm <sup>2</sup>	CI-K4	K-CI-K4	206916	20
	10-35 mm <sup>2</sup>	CI-K5	K-CI-K5	218488	20



207451

## Exterior mounting angle brackets

Description	Suitable for	Part number	Article number	Std. pack
4 angle brackets per set	CI-K4, CI-K5	AB-CI-K4/5	206914	1 off



206914

## Mounting plate shield

Description	Part number	Article number	Std. pack	Suitable for export to North America (US and Canada)	Suitable for
To connect the shielding	MBS-I2 <sup>(1)</sup>	290191	1	✓	CI-K2 Polycarbonate enclosure
	MBS-I4 <sup>(1)</sup>	118742	1	✓	CI-K4 Polycarbonate enclosure



290191

Photos are representative

# Enclosed switch-disconnectors dedicated accessories

## Neutral terminal

- Early make on switching, late-break off switching
- The N contact always behaves as an early-make contact when switching on and as a late-break contact for when switching off.
- N-P1(P3)...switching capacity same as for contacts P1(P3)

Description	Part number	Article number	Std. pack	Suitable for export to North America (US and Canada)	Suitable for	Mounting
For P1.../I2 optionally, NP1Z or HI11-P1/P3Z, can only be fitted on the left	N-P1Z	000652	5	✓	P1	Surface mounting /I2
					P3-63	Surface mounting /I4
					P3-100	Surface mounting /I5



## Auxiliary contacts - 1 normally open (N/O), 1 normally close (N/C)

Late break on switching, early-make off switching. The N/O is always connected as a load-shedding contact

Description	Part number	Article number	Std. pack	Suitable for export to North America (US and Canada)	Suitable for	Mounting
For P1.../I2 optionally, NP1Z or HI11-P1/P3Z, can only be fitted on the left	HI11-P1/P3Z <sup>(1)</sup>	062031	5	✓	P1	Surface mounting /I2
				✓	P3-63	Surface mounting /I4
				✓	P3-63	Rear mounting /V or /Z
				✓	P3-100	Surface mounting /I5

	(1)
Product standards	UL 60947-4-1, CSA - C22-2 No 14-05 IEC/EN 60947-3, CE Marking, UKCA Marking
UL File No	E36332
UL CCN	NLRV
CSA File No	12528
CSA Class No	3211-05
NA Certification	UL Listed, CSA Certified



## P Switch-disconnectors and T cam switches in North American (NA) version

In its NA version the cam switch features a terminal inscription in English and/or a terminal inscription deviating from the IEC standard. Switches in mounting types I2 to I4 feature an additional inscription on the enclosure's front (e.g. part no and protection type). Not possible in combination with key operation lock mechanism S-T0, SVA-T3 and SVC-T3

An overview of these cam switches can be found in the instructional leaflet AWA 1150-2327.

	P1	P3-63	P3-100	T0	T3	T5B
Mounting form /E, /EA, /EZ, /Z, /V, /VS				+NA-12 105864	+NA-12 105864	
/I2	+NA-12 105866				+NA-12 105866	
/I4		+NA-12 105866				
/I5			+NA-12 105869			+NA-15 105869

Photos are representative



# Universal accessories

## Red and yellow main switch assembly kits - For T0, T3, T5B, T5, P1 and P3 Flush, rear and surface mounting switch-disconnectors

- Padlocking feature, lockable with max. 3 padlocks
- For locking in the 0 position, for switches with positions 0 - I at 90°
- Permissible with T0 with up to max. 4 contact units and with T3 with up to max 6 contact units
- Switching angle as front plate FS908
- Designed as per IEC/EN 60204-1. VDE 0113 Part 1

Description	Part number	Article number	Std. pack	Suitable for export to North America (US and Canada)*	Suitable for	Mounting
Red rotary handle with yellow locking ring  As emergency switching off/emergency stop device	SVB-T0	057892	1	✓	T0, T3, P1	Flush mounting /E
					T0, T3, P1	Rear mounting /Z
					T0	Surface mounting /I1
					T3, P1	Surface mounting /I2
Red rotary handle with yellow locking ring  As emergency switching off/emergency stop device	SVB-P3	052999	1	✓	T5B, T5, P3	Flush mounting /E
					T5B, T5, P3	Rear mounting /Z
					T5B, P3-63	Surface mounting /I4
					T5, P3-100	Surface mounting /I5



\* UL/CSA certification not required

## Black main switch assembly kits - For T0, T3, T5B, T5, P1 and P3 Flush, rear and surface mounting switch-disconnectors

- Padlocking feature, lockable with max. 3 padlocks
- For locking in the 0 position, for switches with positions 0 - I at 90°
- Permissible with T0 with up to max. 4 contact units and with T3 with up to max 6 contact units
- Switching angle as front plate FS908
- Designed as per IEC/EN 60204-1. VDE 0113 Part 1

Description	Part number	Article number	Std. pack	Suitable for export to North America (US and Canada)*	Suitable for	Mounting
Black rotary handle and black locking collar  Without emergency switching off/emergency stop device function	SVB-SW-T0	060265	1	✓	T0, T3, P1	Flush mounting /E
					T0, T3, P1	Rear mounting /Z
					T0	Surface mounting /I1
					T3, P1	Surface mounting /I2
Black rotary handle and black locking collar  Without emergency switching off/emergency stop device function	SVB-SW-P3	062491	1	✓	T5B, T5, P3	Flush mounting /E
					T5B, T5, P3	Rear mounting /Z
					T5B, P3-63	Surface mounting /I4
					T5, P3-100	Surface mounting /I5



\* UL/CSA certification not required

Photos are representative

# Universal accessories

## Red and black main switch assembly kits with PE Terminal and N Terminal - For T0, T3 and T5B Flush, and rear mounting switches

- Padlocking feature
- For converting flush mounting switch T.../E into flush mounting main switch T.../EA/SVB
- For converting rear mounting switch T.../Z into rear mounting main switch T.../N/SVB
- Designed as per IEC/EN 60204-1. VDE 0113 Part 1

Description	Part number	Article number	Std. pack	Suitable for export to North America (US and Canada)	Suitable for	Mounting
Red rotary handle with yellow locking ring	V/EA/SVB-T0	062638	1	✓	T0, T3	Flush mounting /E
					T0, T3	Rear mounting /Z
As emergency switching off/emergency stop device	V/EA/SVB/T5	045065	1	✓	T5B	Flush mounting /E
					T5B	Rear mounting /Z
Black rotary handle with black locking ring	V/EA/SVB-SW-T0	065011	1	✓	T0, T3	Flush mounting /E
					T0, T3	Rear mounting /Z
Without emergency switching off/emergency stop function	V/EA/SVB-SW/T5	045064	1	✓	T5B	Flush mounting /E
					T5B	Rear mounting /Z



## Black thumb grip

Description	Part number	Article number	Std. pack	Suitable for export to North America (US and Canada)	Suitable for	Mounting
Black thumb grip	KNB-T0	038909	10	✓	T0, T3, P1	Flush mounting /E
					T0, T3, P1	Centre mounting /EZ
					T0, T3, P1	Service distribution board /IVS
					T0, T3, P1	Rear mounting /Z
					T0	Surface mounting /I1
					T3, P1	Surface mounting /I2
KNB-P3	041282	10	✓	T5B, P3	Flush mounting /E	
				T5B, P3	Rear mounting /Z	
				T5B, T5, P3-63	Surface mounting /I4	
				P3-100	Surface mounting /I5	



## Red thumb grip

- Only for emergency switching off/emergency stop switches
- Designed as per IEC/EN 60204-1. VDE 0113 Part 1
- Order yellow FS908E-T0 front plate additionally

Description	Part number	Article number	Std. pack	Suitable for export to North America (US and Canada)	Suitable for	Mounting
Red thumb grip	KNB-RT-T0	043655	10	✓	T0, T3, P1	Flush mounting /E
					T0, T3, P1	Rear mounting /Z
					T0	Surface mounting /I1
					T3, P1	Surface mounting /I2
KNB-RT-P3	046028	10	✓	T5B, P3	Flush mounting /E	
				T5B, P3	Rear mounting /Z	
				T5B, T5, P3-63	Surface mounting /I4	
				P3-100	Surface mounting /I5	

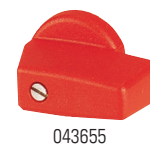

Photos are representative

# Universal accessories

## Front plates

For use with	Switch type	Part number	Article number	Dimensions (W x H x D)	Std. pack	Suitable for export to North America (US and Canada)*
<b>Standard front plate - Suitable for laser inscription</b>						
For frame 48 x 48	T0, T3, P1	FS(*)-T0	231893	45 x 45 mm	10	✓
For frame 88 x 88	P3, T5, T5B	FS(*)-P3	231895	84 x 84 mm	10	✓
<b>Emergency switching off/emergency stop front plates</b>						
For frame 48 x 48	T0, T3, P1	FS908GE-T0	003198	45 x 45 mm	5	✓
For frame 88 x 88	P3, T5, T5B	FS908GE-P3	031475	84 X 84 mm	5	✓
<b>Blank plate - Can be engraved</b>						
For frame 48 x 48	T0, T3, P1	FS-ALU980-T0	266905	45 x 45 mm	50	✓
For frame 88 x 88	P3, T5, T5B	FS-ALU980-P3	266906	84 X 84 mm	10	✓

\* UL/CSA certification not required

### Notes: Standard front plates

For standard switches the normal front plate can be replaced if required with the front plate shown below (not with T6, T8 and TM). Providing the switching angle, number of positions and the position of the 0 are the same.

#### Switching angle 30°



#### Switching angle 45°

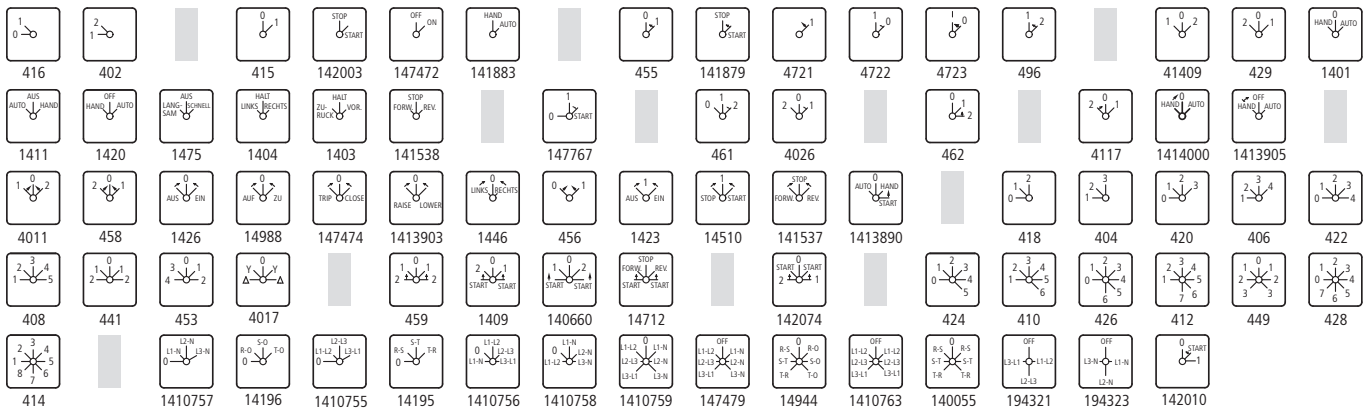

#### Switching angle 60°

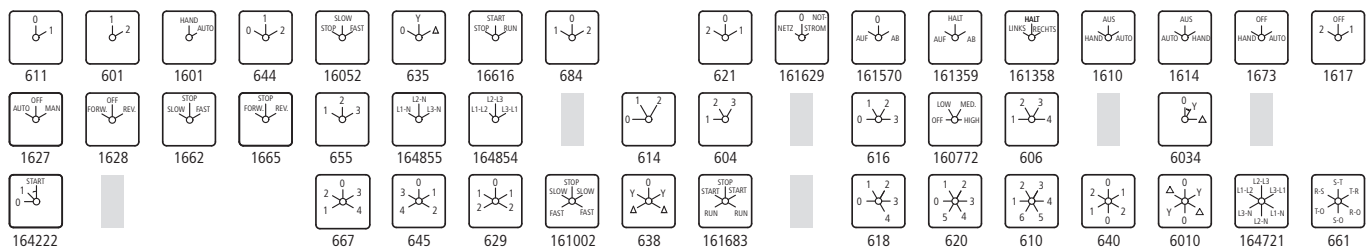

#### Switching angle 90°

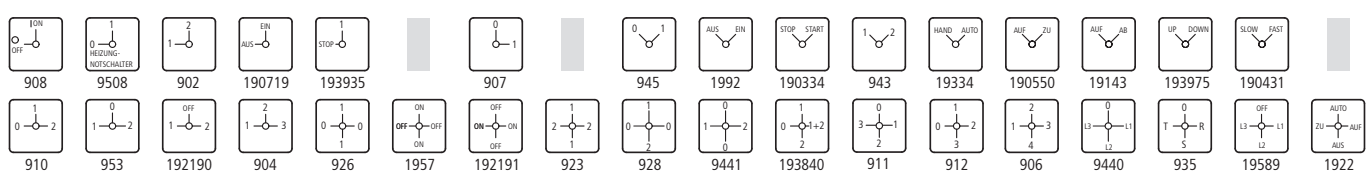

# Universal accessories

## Black label mount and insert label

- For padlocking features consisting of one label and one insert label
- Front plates are already included as a standard with:
  - T../EA/SVB and P../EA/SVB main switches flush mounting
  - T../V/SVB, P../V/SVB main switches for rear mounting

Description	Language	Part number	Article number	Std. pack	Suitable for export to North America (US and Canada)	Suitable for
Inscribed with 'Main switch - Open only in 0 position'	German/English	ZFS61/62-T0	030170	25	✓	T0, T3, P1
		ZFS61/62/P3	065739	25	✓	T5, T5B, P3
	French	ZFS63-T0	047424	25	✓	T0, T3, P1
		ZFS63-P3	047423	25	✓	T5, T5B, P3
	Italian	ZFS68-T0	065751	25	✓	T0, T3, P1
	Portuguese	ZFS68-T0	065751	25	✓	T0, T3, P1
	Swedish	ZFS68-T0	065751	25	✓	T0, T3, P1
	Spanish	ZFS77-T0	065752	25	✓	T0, T3, P1
		ZFS77-P3	047422	25	✓	T5, T5B, P3
	Hungarian	ZFS80-T0	205548	25	✓	T0, T3, P1
ZFS80-P3		205565	25	✓	T5, T5B, P3	
Blank	X	ZFS60-T0	019924	25	✓	T0, T3, P1
		ZFS60-P3	022297	25	✓	T5, T5B, P3



065739



019924

## Label mount, black - clip-on

Description	Part number	Article number	Std. pack	Suitable for export to North America (US and Canada)*	Suitable for
Label mount	ZFSX-T0	024670	25	✓	T0, T3, P1
	ZFSX-P3	027043	25	✓	T5, T5B, P3



## Insert label

Description	Part number	Article number	Std. pack	Suitable for export to North America (US and Canada)*	Suitable for
Blank insert label	BS45X14-T0	029416	25	✓	T0, T3, P1
	BS84X24-P3	031789	25	✓	T5, T5B, P3



## P5 Switch-disconnector add-on front plate

- Enter country reference when ordering
  - D = German
  - GB = English
  - F = French
  - I = Italian
  - E = Spanish

Description	Part number	Article number	Std. pack	Suitable for export to North America (US and Canada)*	Switch type	Mounting
P5 Add-on front plate	ZFS(*)-P5	105225	1	✓	P5../EA/SVB	Flush mounting /EA
				✓	P5../V/SVB	Rear mounting /V



\* UL/CSA certification not required

Photos are representative

## Universal accessories

### S-T0 key operated lock mechanism, with two keys, front IP53

The key replaces the thumb grip, cannot be switched without key. The switch position indication is on the lock. Normally the key is withdrawable in every position.

On Cam switches ordered with front plate FS908 together with key operation, the key is only withdrawable in the 0 position.

The key withdraw can be changed (also retrospectively) with the locking cam 'VR-T0'

When retrofitting the key operation, the existing front plate of the cam switch can be used

Description	Withdrawability	Part number	Article number	Std. pack	Suitable for
KMS 1 lock mechanism: individual lock mechanism, not suitable for master key systems. Key withdrawable in all positions	Withdrawable positions can be programmed by user	S-T0	086709	1	Flush mounting /E: T0-1 to T0-6, T3-1 to T3-5, P1
KMS-2-10, KMS 201-400 lock mechanisms: individual lock mechanisms, not suitable for master key systems. Key withdrawable in all positions	Withdrawable positions can be programmed by user	S-SOND-KMS(*)-T0	231957	1	Surface mounting /I1: T0-1 to T0-4 Surface mounting /I2: T3-1 to T3-4 , P1
Lock KMS1 switches with FS908 are possible as main switch. Key can be withdrawn in positions as specified.	Withdrawable positions programmed at factory as ordered	S(*)-T0	231959	1	Rear mounting /Z: T0-1 to T0-6, T3-1 to T3-4, P1
SA(...) = master key system (master-key facility) with security certificate. Ordering only with lock plan filled out with the <b>full configuration of the planned lock system</b> . When reordering state item number from the lock plan, e.g. (A 6294-1.2). Key can be withdrawn in positions as specified.	Withdrawable positions programmed at factory as ordered	S(*)-SOND-SA(*)-T0	231965	1	



086709

### SVA-T3 Cylinder lock, with two keys, front IP65

Description	Withdrawability	Part number	Article number	Std. pack	Suitable for
KMS 1 lock mechanism: individual lock mechanism, not suitable for master key systems. Key withdrawable in all positions	Withdrawable positions can be programmed by user	SVA-T3	050974	1	Flush mounting /E: T0, T3, P1
KMS-2-10, KMS 201-400 lock mechanisms: individual lock mechanisms, not suitable for master key systems. Key withdrawable in all positions	Withdrawable positions can be programmed by user	SVA-SOND-KMS(*)-T3	231967	1	Surface mounting /I1: T0 Surface mounting /I2: T3, P1  Rear mounting /Z: T0, T3, P1
Lock KMS1 switches with FS908 are possible as main switch. Key can be withdrawn in positions as specified.	Withdrawable positions programmed at factory as ordered	SVA(*)-T3	907745	1	Flush mounting /E: T0-1 to T0-4 T3-1 to T3-6, P1
SA(...) = master key system (master-key facility) with security certificate. Ordering only with lock plan filled out with the <b>full configuration of the planned lock system</b> . When reordering state item number from the lock plan, e.g. (A 6294-1.2). Key can be withdrawn in positions as specified.	Withdrawable positions programmed at factory as ordered	SVA(*)-SOND-SA(*)-T3	231971	1	Surface mounting /I1: T0-1 to T0-4 Surface mounting /I2: T3, P1



050974

Photos are representative

# Universal accessories

## SVC-T3 Padlocking feature, front IP65

The locking slide can be locked with a maximum of 3 padlocks when in its pressed, interlocked position

Description	Withdrawability	Part number	Article number	Std. pack	Mounting form	Suitable for
All positions can be locked	The positions that can be locked can be programmed by the user	SVC-T3	050975	1	Flush mounting /E Surface mounting /I1 Surface mounting /I2 Rear mounting /Z	T0, T3, P1 T0 T3, P1 T0, T3, P1
Specific positions or ranges can be locked	The positions that can be locked are programmable at the factory as ordered	SVC(*)-T3	907748	1	Switches with FS908 front plate can be used as main switches for: Flush mounting /E Surface mounting /I1 Surface mounting /I2	T0-1 to T0-4, T3-1 to T3-5, P1 T0-1 to T0-4 T3-1 to T3-5, P1



907748

## Key

Description	Part number	Article number	Std. pack
For KMS 1 individual lock mechanism	ES-KMS1-T0	231972	10
For KMS 2-10 or KMS 201-400 individual lock mechanisms	ES-KMS(*)-T0	231973	1
Individual key, stainless, for master key system and stored individual lock mechanisms, state lock plan no. and key	HS-SA(*)-T0	256151	1

Master key must be ordered separately.  
The security certificate must be sent when reordering for example: HS-SA(A6294-1-.2)-T0



## Locking cams (2 cams per set)

Description	Part number	Article number	Std. pack	Suitable for export to North America (US and Canada)	Suitable for
For later change of key withdrawability in the engagements positions	VR-T0	089082	1	✓	S-T0 for all switching angles
For changing the blocked positions/ranges	VR-T3	050987	1	✓	SVA-T3, SVC-T3



089082



050987

Photos are representative

# Universal accessories

## P1 and P 3 Neutral terminal

- Early make on switching, late-break off switching
- The N contact always behaves as an early-make contact when switching on and as a late-break contact for when switching off.
- N-P1(P3)...switching capacity same as for contacts P1(P3)

Description	Part number	Article number	Std. pack	Suitable for export to North America (US and Canada)	Suitable for	Mounting
For left or right side mounting	N-P1E	000651	5	✓	P1	Flush mounting /E Centre mounting /EZ
For P1.../I2 optionally, NP1Z or HI11-P1/P3Z, can only be fitted on the left	N-P1Z	000652	5	✓	P1	Surface mounting /I2 Rear mounting /Z Service distribution board/ IVS
	N-P3E	062432	5	✓	P3	Flush mounting /E
	N-P3Z	064805	5	✓	P3	Rear mounting /Z Service distribution board /IVS
					P3-63	Surface mounting /I4 Rear mounting /Z
				P3-100	Surface mounting /I5 Rear mounting /Z	



000652

## P5 Neutral terminal

- Front mounting, left
- Service distribution board mounting right

Description	Part number	Article number	Std. pack	Suitable for export to North America (US and Canada)	Suitable for	Mounting
Neutral terminal	N-P5-125/160E	280969	1	X	P5-125 and 160	Flush mounting /EA
	N-P5-125/160Z	280970	1	X	P5-125 and 160	Rear mounting /V
	N-P5-250/315E	280971	1	X	P5-250 and 315	Flush mounting /EA
	N-P5-250/315Z	280972	1	X	P5-250 and 315	Rear mounting /V



280969

## P5 Ground terminal

- Front mounting, right
- Service distribution board mounting left

Description	Part number	Article number	Std. pack	Suitable for export to North America (US and Canada)	Suitable for	Mounting
Ground terminal	PE-P5-125/160E	280973	1	X	P5-125 and 160	Flush mounting /EA
	PE-P5-125/160Z	280974	1	X	P5-125 and 160	Rear mounting /V
	PE-P5-250/315E	280975	1	X	P5-250 and 315	Flush mounting /EA
	PE-P5-250/315Z	280976	1	X	P5-250 and 315	Rear mounting /V



280974

## P1 Switch terminals

- For use with P1 Switch terminals and additional terminals such as auxiliary and neutral units

Description	Part number	Article number	Std. pack	Suitable for export to North America (US and Canada)	Suitable for	Mounting
Fork terminal	FORKTERM-P1	400136	8	X	P1	All mounting options



Photos are representative

# Universal accessories

## P1 and P3 Auxiliary contacts - 1 normally open (N/O), 1 normally close (N/C)

- Late break on switching, early-make off switching. The N/O is always connected as a load-shedding contact

Description	Part number	Article number	Std. pack	Suitable for export to North America (US and Canada)	Suitable for	Mounting
For left or right side mounting	HI11-PI/P3E	061813	5	✓	P1	Flush mounting /E or /EA
					P1	Center mounting /EZ
					P3	Flush mounting /E or /EA
For P1.../I2 optionally, NP1Z or HI11-P1/P3Z, can only be fitted on the left	HI11-PI/P3Z	062031	5	✓	P1	Surface mounting /I2
					P1	Rear mounting /V or /Z
					P1	Service distribution mounting /IVS
					P3-63	Surface mounting /I4
					P3-63	Rear mounting /V or /Z
					P3-63	Service distribution mounting /IVS
					P3-100	Surface mounting /I5
					P3-100	Rear mounting /V or /Z
	P3-100	Service distribution mounting /IVS				

Product standards	UL 60947-4-1, CSA - C22-2 No 14-05 IEC/EN 60947-3, CE Marking
UL File No	E36332
UL CCN	NLRV
CSA File No	12528
CSA Class No	3211-05
NA Certification	UL Listed, CSA Certified



061813

## P5 Auxiliary contacts - 2 normally open (N/O), 1 normally close (N/C)

Description	Part number	Article number	Std. pack	Suitable for export to North America (US and Canada)	Suitable for	Mounting
For left or right side mounting	HI21-P5-125/160E	280963	1		P5-125 and 160	Flush mounting /EA or /E
	HI21-P5-125/160Z	280964	1		P5-125 and 160	Rear mounting /V or Z
	HI21-P5-250/315E	280965	1		P5-250 and 315	Flush mounting /EA or /E
	HI21-P5-250/315Z	280966	1		P5-250 and 315	Rear mounting /V or Z



280964

## Coupling drive (including push-in shaft)

Description	Part number	Article number	Std. pack	Suitable for export to North America (US and Canada)*	Suitable for	Mounting
Coupling drive for the retrofitting of switch T0 and T0.../XZ as rear mounting spare part to T0 and T3...Z	DE-T0	093487	1	✓	T0, T3	Rear mounting /Z
Coupling drive for the conversion of T5 and T5B.../E Flush mounting switch to rear mounting spare part for T5, T5B and P3.../Z	DE-P3	093972	1	✓	T5, T5B, P3	Flush mounting /E



093487



093972

Photos are representative



# Universal accessories

## Interlock sections

- With PE and neutral terminal connection
- Mounting on the back of flush mounting switch, with interlock function in rear mounting switches

Description	Part number	Article number	Std. pack	Suitable for export to North America (US and Canada)*	Suitable for	Mounting
Interlock sections - Mounting on the back of flush mounting switch	UV-T0	019925	1	✓	T0, T3	Flush mounting /E Centre mounting /EZ Rear mounting /Z
Interlock sections - With interlock function for rear mounting switches	UV-P3	048289	1	✓	T5B, T5	Flush mounting /E Rear mounting /Z



## Shrouds

Description	Part number	Article number	Std. pack	Suitable for export to North America (US and Canada)***	Suitable for	Mounting
For flush mounting switches with up to 4 contact units Cable entries Quantity: 2 x Ø 20 mm + 2 x Ø 15 mm Cross section: 5 x 6 mm <sup>2</sup> , 5 x 2.5 mm <sup>2</sup>	H3-T0	093828	1	✓	T0, T3	Flush mounting /E
For covering the connection terminals of up to 2 contact units*	H1-T5	045062	1	✓	T5B, T5	Flush mounting /E Rear mounting /Z
Extension for H1-T5 protective shroud on 3-8 contact units. One HZ-T5 required per contact unit	HZ-T5	045063	1	✓	H1-T5	
For covering the connection terminals on 3-pole switch-disconnectors*	H-P1	017253	5	✓	P1	Flush mounting /E
			5	✓	P1	Rear mounting /V
For covering the connection terminals on 4-pole switch-disconnectors*	H-P14	019626	5	✓	P1-...N, HI11	All mounting options
For covering the connection terminals on 3-pole open switch-disconnectors with N neutral terminal and/or HI11 auxiliary contact**	H-P3	021999	5	✓	P3	Flush mounting /EA
					P3	Rear mounting /V
					P3-...N, HI11	All mounting options
For covering the terminals	H-P5-125/160	293977	1	✓	P5	All mounting options
					H-P5-250/315	293978
Set (6 units) for covering the connection terminals	H-T8	200184	6	✓	T8-3-8342/...	All mounting options

\* Can be optionally used for input wiring and/or outgoer

\*\* The protective shroud is designed for mounting on the switch-disconnector on both sides; non required parts can be broken off

\*\*\* UL/CSA certification not required



093828



045062



045063



017253



019626



021999



293977 / 293978



200184

Photos are representative

# Universal accessories

## Control cable terminal

Terminal capacity:

- Solid or stranded 4 mm<sup>2</sup>
- Flexible with ferrules to DIN 46228: 4 mm<sup>2</sup>

Description	Part number	Article number	Std. pack	Suitable for export to North America (US and Canada)	Suitable for
Control cable terminal	ST-P5-250/314	280978	1	✓	P5-250/315



## IP65 Insulated enclosures

Description	Number of contact units	Part number	Article number	Std. pack	Suitable for export to North America (US and Canada)	Suitable for	Mounting
IP65 insulated enclosure - With push-through cable entry diaphragm*	1-2	CI-K1-T0-2	207435	1	X	T0	Rear mounting /Z
	3-4	CI-K1-T0-4	207436	1	X		
	1-2	CI-K2-T3-2	207437	1	✓	T3	Rear mounting /Z
	3-4	CI-K2-T3-4	225325	1	✓		
	5	CI-K2-T3-5	207438	1	✓		
IP65 insulated enclosure - With metric knockouts	1-2	CI-K1H-T0-2	105854	1	X	T0	Rear mounting /Z
	3-4	CI-K1H-T0-4	105855	1	X		
	1-2	CI-K2H-T3-2	269462	1	X	T3	Rear mounting /Z
	3-4	CI-K2H-T3-4	105859	1	X		
	5	CI-K2H-T3-5	105860	1	X		
	1-2	CI-K4-T5B-2**	207439	1	✓	T5B	Flush mounting /E
	3-4	CI-K4-T5B-4**	207440	1	✓	T5B	Rear mounting /Z
	1-2	CI-K5-T5-2**	207441	1	✓	T5	Rear mounting /Z
	3-4	CI-K5-T5-4**	207442	1	✓		
	Only available together with basic unit	+I1H	105870	1	X	T0	Surface mounting I1
	+I2H	105871	1	X	T3	Surface mounting I2	
				X	P1	Surface mounting I2	

\* The diaphragm can be pierced with the cable. 1 contact unit = 2 contacts.

\*\* For converting T5-./Z into T5-./I5 and T5B-./E into T5B-./I4, order AW-T5-... extension terminal additionally. 1 contact unit = 2 contacts



207435 / 207436  
105855 /



207437 / 269462  
105859 / 105860



225325



207438



105854 / 105870  
105871



207439 / 207440



207441



207442

Product standards	UL 60947-4-1 CSA - C22-2 No 14-05, CSA - C22-2 No 94 IEC/EN 60947-3 CE Marking
UL File No	E54120
UL CCN	MITW2
CSA File No	12528
CSA Class No	3211-07
NA Certification	UL Listed, CSA Certified
Degree of protection	IEC: IP65 UL/CSA Type 1, 3R, 4X, 12, 13 - indoor and outdoor use

Photos are representative

# Universal accessories

## Neutral terminals

Description	Flex cable	Part number	Article number	Std. pack	Suitable for export to North America (US and Canada)*	Suitable for	Mounting
Neutral terminal for connection of a 5th conductor	1-4 mm <sup>2</sup>	K-CI-K1/2*	207451	20	✓	P1	Surface mounting I2
						T0	Surface mounting I1
						T3	Surface mounting I3
	1.5-16 mm <sup>2</sup>	K-CI-K4	206916	20	✓	T5B	Surface mounting I4
						P3	Surface mounting I4
	10-35 mm <sup>2</sup>	K-CI-K5	218488	20	✓	T5	Surface mounting I5
						P3	Surface mounting I5

\* UL/CSA certification not required



206916



218488

## Set of external brackets

Description	Part number	Article number	Std. pack	Suitable for export to North America (US and Canada)*	Suitable for	Mounting
Set of external fixing brackets, for fixing CI-K4 and CI-K5 directly on walls.  One set contains 4 brackets	AB-CI-K4/5	206914	1	✓	T5B	Surface mounting I4
					P3-63	Surface mounting I4
					T5	Surface mounting I5
					P3-100	Surface mounting I5

\* UL/CSA certification not required



Photos are representative

# Customised switch-disconnectors design service

Eaton supports custom solutions to suit your application needs thanks to over 50 years of expert knowledge in Switch-disconnectors design.

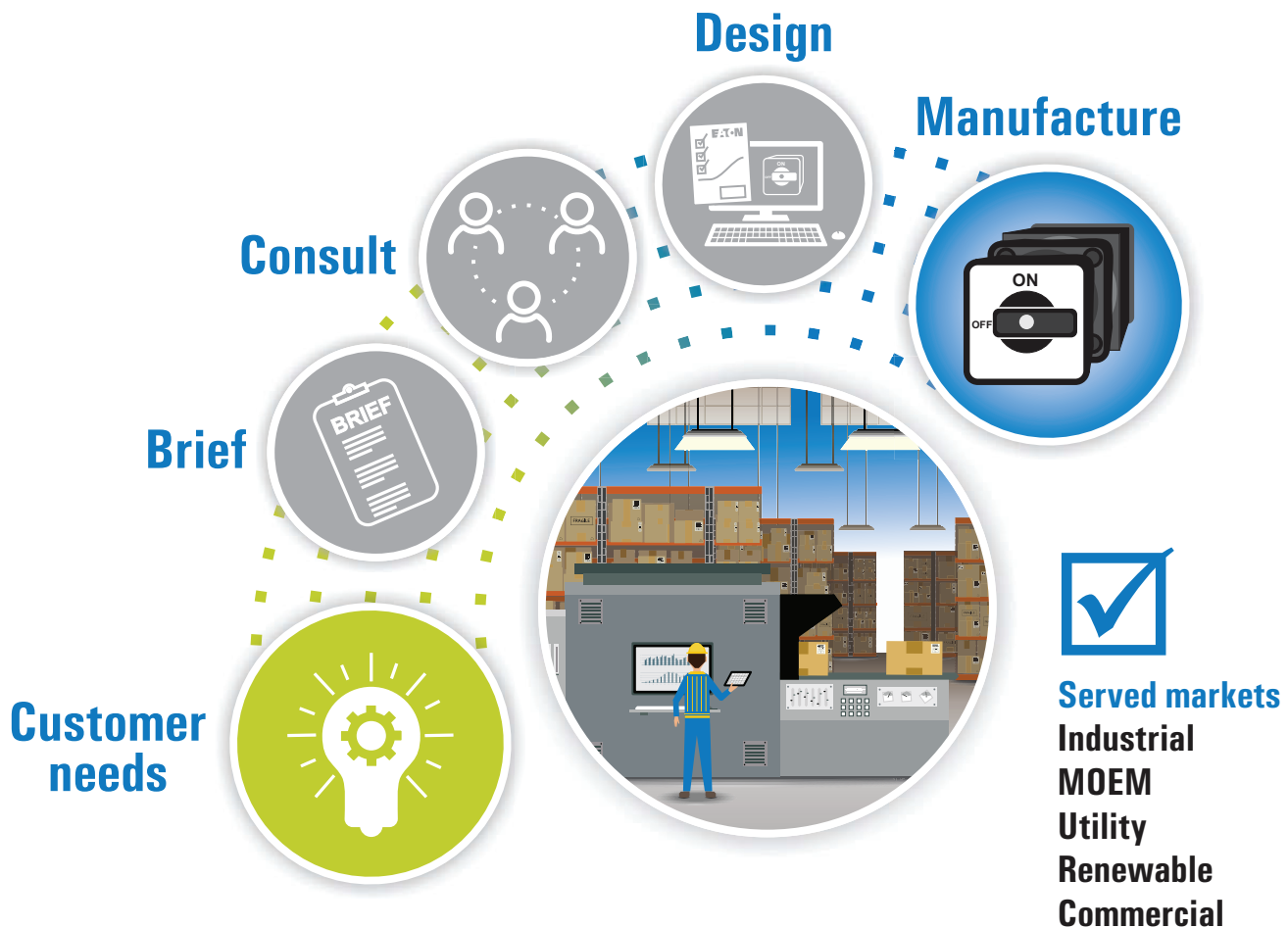

## Our services include:

- Customised mounting connections.
- Acquire UL/IEC/CCC/CSA certificates.
- Customised testing such as temperature rise or vibration.
- Special plating for connection terminal.
- Modification of enclosures.
- Additional earthing arrangements.
- Custom printed face plates.
- Unique control switching configurations.

## Contact us today...

[buletechnical@eaton.com](mailto:buletechnical@eaton.com)

# Non standard Cam switches and Switch-disconnectors

## T0 Cam switches

Rated current	Number of contact chambers	Mounting option	Main switch	Handle colour	Part number	Article number	Suitable for export to North America (US and Canada)
20 A	1	Flush mounting		Red	T0-1-SOND*/E	907765	✓
		Flush mounting	✓	Red	T0-1-SOND*/EA/SVB	907776	✓
		Flush mounting	✓	Black	T0-1-SOND*/EA/SVB-SW	908043	✓
		Centre mounting		Red	T0-1-SOND*/EZ	907787	✓
		Surface mounting in size 1 Ci-K Enclosure		Red	T0-1-SOND*/I1	207480	✓
		Surface mounting in size 1 Ci-K Enclosure	✓	Red	T0-1-SOND*/I1/SVB	207481	✓
		Surface mounting in size 1 Ci-K Enclosure	✓	Black	T0-1-SOND*/I1/SVB-SW	207482	✓
		Service distribution board		Red	T0-1-SOND*/IVS	907806	✓
		Rear mounting	✓	Red	T0-1-SOND*/V/SVB	907817	✓
		Rear mounting	✓	Black	T0-1-SOND*/V/SVB-SW	908054	✓
		Rear mounting		Red	T0-1-SOND*/Z	907839	✓
		2	Flush mounting		Red	T0-2-SOND*/E	907766
	Flush mounting		✓	Red	T0-2-SOND*/EA/SVB	907777	✓
	Flush mounting		✓	Black	T0-2-SOND*/EA/SVB-SW	908044	✓
	Centre mounting			Red	T0-2-SOND*/EZ	907788	✓
	Surface mounting in size 1 Ci-K Enclosure			Red	T0-2-SOND*/I1	207483	✓
	Surface mounting in size 1 Ci-K Enclosure		✓	Red	T0-2-SOND*/I1/SVB	207484	✓
	Surface mounting in size 1 Ci-K Enclosure		✓	Black	T0-2-SOND*/I1/SVB-SW	207485	✓
	Service distribution board			Red	T0-2-SOND*/IVS	907807	✓
	Rear mounting		✓	Red	T0-2-SOND*/V/SVB	907818	✓
	Rear mounting		✓	Black	T0-2-SOND*/V/SVB-SW	908055	✓
	Rear mounting			Red	T0-2-SOND*/Z	907840	✓
	3		Flush mounting		Red	T0-3-SOND*/E	907767
		Flush mounting	✓	Red	T0-3-SOND*/EA/SVB	907778	✓
		Flush mounting	✓	Black	T0-3-SOND*/EA/SVB-SW	908045	✓
		Centre mounting		Red	T0-3-SOND*/EZ	907789	✓
		Surface mounting in size 1 Ci-K Enclosure		Red	T0-3-SOND*/I1	207486	✓
		Surface mounting in size 1 Ci-K Enclosure	✓	Red	T0-3-SOND*/I1/SVB	207487	✓
		Surface mounting in size 1 Ci-K Enclosure	✓	Black	T0-3-SOND*/I1/SVB-SW	207488	✓
		Service distribution board		Red	T0-3-SOND*/IVS	907808	✓
		Rear mounting	✓	Red	T0-3-SOND*/V/SVB	907819	✓
		Rear mounting	✓	Black	T0-3-SOND*/V/SVB-SW	908056	✓
		Rear mounting		Red	T0-3-SOND*/Z	907841	✓
		4	Flush mounting		Red	T0-4-SOND*/E	907768
	Flush mounting		✓	Red	T0-4-SOND*/EA/SVB	907779	✓
	Flush mounting		✓	Black	T0-4-SOND*/EA/SVB-SW	908046	✓
Centre mounting			Red	T0-4-SOND*/EZ	907790	✓	
Surface mounting in size 1 Ci-K Enclosure			Red	T0-4-SOND*/I1	207489	✓	
Surface mounting in size 1 Ci-K Enclosure	✓		Red	T0-4-SOND*/I1/SVB	207490	✓	
Surface mounting in size 1 Ci-K Enclosure	✓		Black	T0-4-SOND*/I1/SVB-SW	207491	✓	
Service distribution board			Red	T0-4-SOND*/IVS	907809	✓	
Rear mounting	✓		Red	T0-4-SOND*/V/SVB	907820	✓	
Rear mounting	✓		Black	T0-4-SOND*/V/SVB-SW	908057	✓	
Rear mounting			Red	T0-4-SOND*/Z	907842	✓	

**Note:** Please use the 'Ordering non-standard contact sequences' order form when ordering for the first time. When placing repeat orders, specify the contact sequence number together (e.g. 47110GB).

Product standards	UL508, CSA - C22-2 No 14-05, IEC/EN 60947-3, CE Marking			
UL File No	E36332			
UL CCN	NLRV			
CSA File No	12528			
CSA Class No	3211-05			
NA Certification	UL Listed, CSA Certified			
Degree of protection	IEC; IP65 UL/CSA Type 3R, 12	X	IEC; IP65 UL/CSA Type:-	IEC IP30 UL/CSA Type: None

# Non standard Cam switches and Switch-disconnectors

## T0 Cam switches

Rated current	Number of contact chambers	Mounting option	Main switch	Handle colour	Part number	Article number	Suitable for export to North America (US and Canada)
20 A	5	Flush mounting		Red	T0-5-SOND*/E	907769	✓
		Centre mounting		Red	T0-5-SOND*/EZ	907791	✓
		Service distribution board		Red	T0-5-SOND*/IVS	907810	✓
		Rear mounting		Red	T0-5-SOND*/Z	907843	✓
	6	Flush mounting		Red	T0-6-SOND*/E	907770	✓
		Centre mounting		Red	T0-6-SOND*/EZ	907792	✓
		Service distribution board		Red	T0-6-SOND*/IVS	907811	✓
		Rear mounting		Red	T0-6-SOND*/Z	907844	✓
	7	Flush mounting		Red	T0-7-SOND*/E	907771	✓
		Centre mounting		Red	T0-7-SOND*/EZ	907793	✓
		Service distribution board		Red	T0-7-SOND*/IVS	907812	✓
		Rear mounting		Red	T0-7-SOND*/Z	907845	✓
	8	Flush mounting		Red	T0-8-SOND*/E	907772	✓
		Centre mounting		Red	T0-8-SOND*/EZ	907794	✓
		Service distribution board		Red	T0-8-SOND*/IVS	907813	✓
		Rear mounting		Red	T0-8-SOND*/Z	907846	✓
	9	Flush mounting		Red	T0-9-SOND*/E	907773	✓
		Centre mounting		Red	T0-9-SOND*/EZ	907795	✓
		Service distribution board		Red	T0-9-SOND*/IVS	907814	✓
		Rear mounting		Red	T0-9-SOND*/Z	907847	✓
10	Flush mounting		Red	T0-10-SOND*/E	907774	✓	
	Centre mounting		Red	T0-10-SOND*/EZ	907796	✓	
	Service distribution board		Red	T0-10-SOND*/IVS	907815	✓	
	Rear mounting		Red	T0-11-SOND*/Z	907848	✓	
11	Flush mounting		Red	T0-11-SOND*/E	907775	✓	
	Centre mounting		Red	T0-11-SOND*/EZ	907797	✓	
	Service distribution board		Red	T0-11-SOND*/IVS	907816	✓	
	Rear mounting		Red	T0-11-SOND*/Z	907849	✓	

**Note:** Please use the 'Ordering non-standard contact sequences' order form when ordering for the first time. When placing repeat orders, specify the contact sequence number together (e.g. 47110GB).

Product standards	UL508, CSA - C22-.2 No 14-05 , IEC/EN 60947-3, CE Marking			
UL File No	E36332			
UL CCN	NLRV			
CSA File No	12528			
CSA Class No	3211-05			
NA Certification	UL Listed, CSA Certified			
Degree of protection	IEC; IP65 UL/CSA Type 3R, 12	X	IEC; IP65 UL/CSA Type:-	IEC IP30 UL/CSA Type: None

# Non standard Cam switches and Switch-disconnectors

## T3 Cam switches

Rated current	Number of contact chambers	Mounting option	Main switch	Handle colour	Part number	Article number	Suitable for export to North America (US and Canada)
32 A	1	Flush mounting		Red	T3-1-SOND*/E	907850	✓
		Flush mounting	✓	Red	T3-1-SOND*/EA/SVB	907861	✓
		Flush mounting	✓	Black	T3-1-SOND*/EA/SVB-SW	908080	✓
		Centre mounting		Red	T3-1-SOND*/EZ	907872	✓
		Surface mounting in size 2 Ci-K Enclosure		Red	T3-1-SOND*/I2	207492	✓
		Surface mounting in size 2 Ci-K Enclosure	✓	Red	T3-1-SOND*/I2/SVB	207493	✓
		Surface mounting in size 2 Ci-K Enclosure	✓	Black	T3-1-SOND*/I2/SVB-SW	207494	✓
		Rear mounting	✓	Red	T3-1-SOND*/V/SVB	907891	✓
		Rear mounting	✓	Black	T3-1-SOND*/V/SVB-SW	908091	✓
	Rear mounting		Red	T3-1-SOND*/Z	907913	✓	
	2	Flush mounting		Red	T3-1-SOND*/E	907850	✓
		Flush mounting	✓	Red	T3-1-SOND*/EA/SVB	907861	✓
		Flush mounting	✓	Black	T3-1-SOND*/EA/SVB-SW	908080	✓
		Centre mounting		Red	T3-1-SOND*/EZ	907872	✓
		Surface mounting in size 2 Ci-K Enclosure		Red	T3-1-SOND*/I2	207492	✓
		Surface mounting in size 2 Ci-K Enclosure	✓	Red	T3-1-SOND*/I2/SVB	207493	✓
		Surface mounting in size 2 Ci-K Enclosure	✓	Black	T3-1-SOND*/I2/SVB-SW	207494	✓
		Rear mounting	✓	Red	T3-1-SOND*/V/SVB	907891	✓
		Rear mounting	✓	Black	T3-1-SOND*/V/SVB-SW	908091	✓
	Rear mounting		Red	T3-1-SOND*/Z	907913	✓	
	3	Flush mounting		Red	T3-1-SOND*/E	907852	✓
		Flush mounting	✓	Red	T3-1-SOND*/EA/SVB	907863	✓
		Flush mounting	✓	Black	T3-1-SOND*/EA/SVB-SW	908082	✓
		Centre mounting		Red	T3-1-SOND*/EZ	907874	✓
		Surface mounting in size 2 Ci-K Enclosure		Red	T3-1-SOND*/I2	207498	✓
		Surface mounting in size 2 Ci-K Enclosure	✓	Red	T3-1-SOND*/I2/SVB	207499	✓
		Surface mounting in size 2 Ci-K Enclosure	✓	Black	T3-1-SOND*/I2/SVB-SW	207500	✓
		Rear mounting	✓	Red	T3-1-SOND*/V/SVB	907893	✓
		Rear mounting	✓	Black	T3-1-SOND*/V/SVB-SW	908093	✓
	Rear mounting		Red	T3-1-SOND*/Z	907915	✓	
	4	Flush mounting		Red	T3-1-SOND*/E	907852	✓
		Flush mounting	✓	Red	T3-1-SOND*/EA/SVB	907863	✓
		Flush mounting	✓	Black	T3-1-SOND*/EA/SVB-SW	908082	✓
		Centre mounting		Red	T3-1-SOND*/EZ	907874	✓
		Surface mounting in size 2 Ci-K Enclosure		Red	T3-1-SOND*/I2	207498	✓
		Surface mounting in size 2 Ci-K Enclosure	✓	Red	T3-1-SOND*/I2/SVB	207499	✓
Surface mounting in size 2 Ci-K Enclosure		✓	Black	T3-1-SOND*/I2/SVB-SW	207500	✓	
Rear mounting		✓	Red	T3-1-SOND*/V/SVB	907893	✓	
Rear mounting		✓	Black	T3-1-SOND*/V/SVB-SW	908093	✓	
Rear mounting		Red	T3-1-SOND*/Z	907915	✓		

**Note:** Please use the 'Ordering non-standard contact sequences' order form when ordering for the first time. When placing repeat orders, specify the contact sequence number together (e.g. 47110GB).

Degree of protection	X	IEC: IP65 UL/CSA Type 3R, 12
Product standards	UL508, CSA - C22-2 No 14-05 , IEC/EN 60947-3, CE Marking	
UL File No	E36332	
UL CCN	NLRV	
CSA File No	12528	
CSA Class No	3211-05	
NA Certification	UL Listed, CSA Certified	

# Non standard Cam switches and Switch-disconnectors

## T3 Cam switches

Rated current	Number of contact chambers	Mounting option	Main switch	Handle colour	Part number	Article number	Suitable for export to North America (US and Canada)
32 A	5	Flush mounting		Red	T3-5-SOND*/E	907850	✓
		Flush mounting	✓	Red	T3-5-SOND*/EA/SVB	907861	✓
		Flush mounting	✓	Black	T3-5-SOND*/EA/SVB-SW	908080	✓
		Centre mounting		Red	T3-5-SOND*/EZ	907872	✓
		Surface mounting in size 2 Ci-K Enclosure		Red	T3-5-SOND*/I2	207492	✓
		Surface mounting in size 2 Ci-K Enclosure	✓	Red	T3-5-SOND*/I2/SVB	207493	✓
		Surface mounting in size 2 Ci-K Enclosure	✓	Black	T3-5-SOND*/I2/SVB-SW	207494	✓
		Rear mounting	✓	Red	T3-5-SOND*/V/SVB	907891	✓
		Rear mounting	✓	Black	T3-5-SOND*/V/SVB-SW	908091	✓
		Rear mounting		Red	T3-5-SOND*/Z	907913	✓
6		Flush mounting		Red	T3-6-SOND*/E	907855	✓
		Flush mounting	✓	Red	T3-6-SOND*/EA/SVB	907866	✓
		Flush mounting	✓	Black	T3-6-SOND*/EA/SVB-SW	908085	✓
		Centre mounting		Red	T3-6-SOND*/EZ	907877	✓
		Rear mounting	✓	Red	T3-6-SOND*/V/SVB	907896	✓
		Rear mounting	✓	Black	T3-6-SOND*/V/SVB-SW	908096	✓
		Rear mounting		Red	T3-6-SOND*/Z	907918	✓
7		Flush mounting		Red	T3-7-SOND*/E	907856	✓
		Centre mounting		Red	T3-7-SOND*/EZ	907878	✓
		Rear mounting		Red	T3-7-SOND*/Z	907919	✓
8		Flush mounting		Red	T3-8-SOND*/E	907857	✓
		Centre mounting		Red	T3-8-SOND*/EZ	907879	✓
		Rear mounting		Red	T3-8-SOND*/Z	907920	✓
9		Flush mounting		Red	T3-9-SOND*/E	907858	✓
		Centre mounting		Red	T3-9-SOND*/EZ	907880	✓
		Rear mounting		Red	T3-9-SOND*/Z	907921	✓
10		Flush mounting		Red	T3-10-SOND*/E	907859	✓
		Centre mounting		Red	T3-10-SOND*/EZ	907881	✓
		Rear mounting		Red	T3-10-SOND*/Z	907922	✓
11		Flush mounting		Red	T3-11-SOND*/E	907860	✓
		Centre mounting		Red	T3-11-SOND*/EZ	907882	✓
		Rear mounting		Red	T3-11-SOND*/Z	907923	✓

**Note:** Please use the 'Ordering non-standard contact sequences' order form when ordering for the first time. When placing repeat orders, specify the contact sequence number together (e.g. 47110GB).

Degree of protection	X	IEC: IP65 UL/CSA Type 3R, 12
Product standards	UL508, CSA - C22-.2 No 14-05 , IEC/EN 60947-3, CE Marking	
UL File No	E36332	
UL CCN	NLRV	
CSA File No	12528	
CSA Class No	3211-05	
NA Certification	UL Listed, CSA Certified	



# Non standard Cam switches and Switch-disconnectors

## T5B Cam switches

Rated current	Number of contact chambers	Mounting option	Main switch	Handle colour	Part number	Article number	Suitable for export to North America (US and Canada)
63 A	1	Flush mounting		Red	T5B-1-SOND*/E	907924	✓
		Flush mounting	✓	Red	T5B-1-SOND*/EA/SVB	907934	✓
		Flush mounting	✓	Black	T5B-1-SOND*/EA/SVB-SW	908106	✓
		Surface mounting in size 4 Ci-K Enclosure		Red	T5B-1-SOND*/I4	207510	✓
		Surface mounting in size 4 Ci-K Enclosure	✓	Red	T5B-1-SOND*/I4/SVB	207511	✓
		Surface mounting in size 4 Ci-K Enclosure	✓	Black	T5B-1-SOND*/I4/SVB-SW	207512	✓
		Rear mounting	✓	Red	T5B-1-SOND*/V/SVB	907950	✓
		Rear mounting	✓	Black	T5B-1-SOND*/V/SVB-SW	908114	✓
		Rear mounting		Red	T5B-1-SOND*/Z	907968	✓
	2	Flush mounting		Red	T5B-2-SOND*/E	907925	✓
		Flush mounting	✓	Red	T5B-2-SOND*/EA/SVB	907935	✓
		Flush mounting	✓	Black	T5B-2-SOND*/EA/SVB-SW	908107	✓
		Surface mounting in size 4 Ci-K Enclosure		Red	T5B-2-SOND*/I4	207514	✓
		Surface mounting in size 4 Ci-K Enclosure	✓	Red	T5B-2-SOND*/I4/SVB	207515	✓
		Surface mounting in size 4 Ci-K Enclosure	✓	Black	T5B-2-SOND*/I4/SVB-SW	207516	✓
		Rear mounting	✓	Red	T5B-2-SOND*/V/SVB	907951	✓
		Rear mounting	✓	Black	T5B-2-SOND*/V/SVB-SW	908115	✓
		Rear mounting		Red	T5B-2-SOND*/Z	907969	✓
	3	Flush mounting		Red	T5B-3-SOND*/E	907926	✓
		Flush mounting	✓	Red	T5B-3-SOND*/EA/SVB	907936	✓
		Flush mounting	✓	Black	T5B-3-SOND*/EA/SVB-SW	908108	✓
		Surface mounting in size 4 Ci-K Enclosure		Red	T5B-3-SOND*/I4	207518	✓
		Surface mounting in size 4 Ci-K Enclosure	✓	Red	T5B-3-SOND*/I4/SVB	207519	✓
		Surface mounting in size 4 Ci-K Enclosure	✓	Black	T5B-3-SOND*/I4/SVB-SW	207520	✓
		Rear mounting	✓	Red	T5B-3-SOND*/V/SVB	907952	✓
		Rear mounting	✓	Black	T5B-3-SOND*/V/SVB-SW	908116	✓
		Rear mounting		Red	T5B-3-SOND*/Z	907970	✓
	4	Flush mounting		Red	T5B-4-SOND*/E	907927	✓
Flush mounting		✓	Red	T5B-4-SOND*/EA/SVB	907937	✓	
Flush mounting		✓	Black	T5B-4-SOND*/EA/SVB-SW	908109	✓	
Surface mounting in size 4 Ci-K Enclosure			Red	T5B-4-SOND*/I4	207521	✓	
Surface mounting in size 4 Ci-K Enclosure		✓	Red	T5B-4-SOND*/I4/SVB	207522	✓	
Surface mounting in size 4 Ci-K Enclosure		✓	Black	T5B-4-SOND*/I4/SVB-SW	207523	✓	
Rear mounting		✓	Red	T5B-4-SOND*/V/SVB	907953	✓	
Rear mounting		✓	Black	T5B-4-SOND*/V/SVB-SW	908117	✓	
Rear mounting			Red	T5B-4-SOND*/Z	907971	✓	

**Note:** Please use the 'Ordering non-standard contact sequences' order form when ordering for the first time. When placing repeat orders, specify the contact sequence number together (e.g. 47110GB).

Product standards	UL508, CSA - C22-2 No 14-05, IEC/EN 60947-3, CE Marking
UL File No	E36332
UL CCN	NLRV7
CSA File No	12528
CSA Class No	3211-05
NA Certification	UL Listed, CSA Certified

# Non standard Cam switches and Switch-disconnectors

## T5B Cam switches

Rated current	Number of contact chambers	Mounting option	Main switch	Handle colour	Part number	Article number	Suitable for export to North America (US and Canada)
63 A	5	Flush mounting		Red	T5B-5-SOND*/E	907928	✓
		Flush mounting	✓	Red	T5B-5-SOND*/EA/SVB	907938	✓
		Flush mounting	✓	Black	T5B-5-SOND*/EA/SVB-SW	908110	✓
		Rear mounting	✓	Red	T5B-5-SOND*/V/SVB	907954	✓
		Rear mounting	✓	Black	T5B-5-SOND*/V/SVB-SW	908118	✓
		Rear mounting		Red	T5B-5-SOND*/Z	907972	✓
	6	Flush mounting		Red	T5B-6-SOND*/E	907929	✓
		Flush mounting	✓	Red	T5B-6-SOND*/EA/SVB	907939	✓
		Flush mounting	✓	Black	T5B-6-SOND*/EA/SVB-SW	908111	✓
		Rear mounting	✓	Red	T5B-6-SOND*/V/SVB	907955	✓
		Rear mounting	✓	Black	T5B-6-SOND*/V/SVB-SW	908119	✓
		Rear mounting		Red	T5B-6-SOND*/Z	907973	✓
	7	Flush mounting		Red	T5B-7-SOND*/E	907930	✓
		Flush mounting	✓	Red	T5B-7-SOND*/EA/SVB	907940	✓
		Flush mounting	✓	Black	T5B-7-SOND*/EA/SVB-SW	908112	✓
		Rear mounting	✓	Red	T5B-7-SOND*/V/SVB	907956	✓
		Rear mounting	✓	Black	T5B-7-SOND*/V/SVB-SW	908120	✓
		Rear mounting		Red	T5B-7-SOND*/Z	907974	✓
8	Flush mounting		Red	T5B-8-SOND*/E	907931	✓	
	Flush mounting	✓	Red	T5B-8-SOND*/EA/SVB	907941	✓	
	Flush mounting	✓	Black	T5B-8-SOND*/EA/SVB-SW	908113	✓	
	Rear mounting	✓	Red	T5B-8-SOND*/V/SVB	907957	✓	
	Rear mounting	✓	Black	T5B-8-SOND*/V/SVB-SW	908121	✓	
	Rear mounting		Red	T5B-8-SOND*/Z	907975	✓	
9	Flush mounting		Red	T5B-9-SOND*/E	907932	✓	
	Rear mounting		Red	T5B-9-SOND*/Z	907976	✓	
10	Flush mounting		Red	T5B-10-SOND*/E	907933	✓	
	Rear mounting		Red	T5B-10-SOND*/Z	907977	✓	

**Note:** Please use the 'Ordering non-standard contact sequences' order form when ordering for the first time. When placing repeat orders, specify the contact sequence number together (e.g. 47110GB).

Product standards	UL508, CSA - C22-2 No 14-05, IEC/EN 60947-3, CE Marking
UL File No	E36332
UL CCN	NLRV7
CSA File No	12528
CSA Class No	3211-05
NA Certification	UL Listed, CSA Certified

# Non standard Cam switches and Switch-disconnectors

## T5 Cam switches

Rated current	Number of contact chambers	Mounting option	Main switch	Handle colour	Part number	Article number	Suitable for export to North America (US and Canada)
100 A	1	Flush mounting		Red	T5-1-SOND*/E	907978	✓
		Flush mounting	✓	Red	T5-1-SOND*/EA/SVB	908031	✓
		Flush mounting	✓	Black	T5-1-SOND*/EA/SVB-SW	908126	✓
		Surface mounting in size 5 Ci-K Enclosure		Red	T5-1-SOND*/I4	207524	✓
		Surface mounting in size 5 Ci-K Enclosure	✓	Red	T5-1-SOND*/I4/SVB	207525	✓
		Surface mounting in size 5 Ci-K Enclosure	✓	Black	T5-1-SOND*/I4/SVB-SW	207526	✓
		Rear mounting	✓	Red	T5-1-SOND*/V/SVB	908003	✓
		Rear mounting	✓	Black	T5-1-SOND*/V/SVB-SW	908134	✓
		Rear mounting		Red	T5-1-SOND*/Z	908021	✓
	2	Flush mounting		Red	T5-2-SOND*/E	907979	✓
		Flush mounting	✓	Red	T5-2-SOND*/EA/SVB	907988	✓
		Flush mounting	✓	Black	T5-2-SOND*/EA/SVB-SW	908127	✓
		Surface mounting in size 4 Ci-K Enclosure		Red	T5-2-SOND*/I4	207527	✓
		Surface mounting in size 4 Ci-K Enclosure	✓	Red	T5-2-SOND*/I4/SVB	207528	✓
		Surface mounting in size 4 Ci-K Enclosure	✓	Black	T5-2-SOND*/I4/SVB-SW	207529	✓
		Rear mounting	✓	Red	T5-2-SOND*/V/SVB	908004	✓
		Rear mounting	✓	Black	T5-2-SOND*/V/SVB-SW	908135	✓
		Rear mounting		Red	T5-2-SOND*/Z	908022	✓
	3	Flush mounting		Red	T5-3-SOND*/E	907980	✓
		Flush mounting	✓	Red	T5-3-SOND*/EA/SVB	907989	✓
		Flush mounting	✓	Black	T5-3-SOND*/EA/SVB-SW	908128	✓
		Surface mounting in size 4 Ci-K Enclosure		Red	T5-3-SOND*/I4	207530	✓
		Surface mounting in size 4 Ci-K Enclosure	✓	Red	T5-3-SOND*/I4/SVB	207531	✓
		Surface mounting in size 4 Ci-K Enclosure	✓	Black	T5-3-SOND*/I4/SVB-SW	207532	✓
		Rear mounting	✓	Red	T5-3-SOND*/V/SVB	908005	✓
		Rear mounting	✓	Black	T5-3-SOND*/V/SVB-SW	908136	✓
		Rear mounting		Red	T5-3-SOND*/Z	908023	✓
4	Flush mounting		Red	T5-4-SOND*/E	907981	✓	
	Flush mounting	✓	Red	T5-4-SOND*/EA/SVB	907990	✓	
	Flush mounting	✓	Black	T5-4-SOND*/EA/SVB-SW	908129	✓	
	Surface mounting in size 4 Ci-K Enclosure		Red	T5-4-SOND*/I4	207533	✓	
	Surface mounting in size 4 Ci-K Enclosure	✓	Red	T5-4-SOND*/I4/SVB	207534	✓	
	Surface mounting in size 4 Ci-K Enclosure	✓	Black	T5-4-SOND*/I4/SVB-SW	207535	✓	
	Rear mounting	✓	Red	T5-4-SOND*/V/SVB	908005	✓	
	Rear mounting	✓	Black	T5-4-SOND*/V/SVB-SW	908137	✓	

**Note:** Please use the 'Ordering non-standard contact sequences' order form when ordering for the first time. When placing repeat orders, specify the contact sequence number together (e.g. 47110GB).

Product standards	UL508, CSA - C22-.2 No 14-05, IEC/EN 60947-3, CE Marking
UL File No	E36332
UL CCN	NLRV7
CSA File No	12528
CSA Class No	3211-05
NA Certification	UL Listed, CSA Certified

# Non standard Cam switches and Switch-disconnectors

## T5 Cam switches

Rated current	Number of contact chambers	Mounting option	Main switch	Handle colour	Part number	Article number	Suitable for export to North America (US and Canada)
100 A	5	Flush mounting		Red	T5-5-SOND*/E	907982	✓
		Flush mounting	✓	Red	T5-5-SOND*/EA/SVB	908991	✓
		Flush mounting	✓	Black	T5-5-SOND*/EA/SVB-SW	908130	✓
		Rear mounting	✓	Red	T5-5-SOND*/V/SVB	908007	✓
		Rear mounting	✓	Black	T5-5-SOND*/V/SVB-SW	908138	✓
		Rear mounting		Red	T5-5-SOND*/Z	908025	✓
	6	Flush mounting		Red	T5-6-SOND*/E	907983	✓
		Flush mounting	✓	Red	T5-6-SOND*/EA/SVB	908992	✓
		Flush mounting	✓	Black	T5-6-SOND*/EA/SVB-SW	908131	✓
		Rear mounting	✓	Red	T5-6-SOND*/V/SVB	908008	✓
		Rear mounting	✓	Black	T5-6-SOND*/V/SVB-SW	908139	✓
		Rear mounting		Red	T5-6-SOND*/Z	908026	✓
	7	Flush mounting		Red	T5-7-SOND*/E	907984	✓
		Flush mounting	✓	Red	T5-7-SOND*/EA/SVB	908993	✓
		Flush mounting	✓	Black	T5-7-SOND*/EA/SVB-SW	908132	✓
		Rear mounting	✓	Red	T5-7-SOND*/V/SVB	908009	✓
		Rear mounting	✓	Black	T5-7-SOND*/V/SVB-SW	908140	✓
		Rear mounting		Red	T5-7-SOND*/Z	908027	✓
	8	Flush mounting		Red	T5-8-SOND*/E	907985	✓
		Flush mounting	✓	Red	T5-8-SOND*/EA/SVB	908994	✓
		Flush mounting	✓	Black	T5-8-SOND*/EA/SVB-SW	908133	✓
Rear mounting		✓	Red	T5-8-SOND*/V/SVB	908010	✓	
Rear mounting		✓	Black	T5-8-SOND*/V/SVB-SW	908141	✓	
Rear mounting			Red	T5-8-SOND*/Z	908028	✓	
9	Flush mounting		Red	T5-9-SOND*/E	907986	✓	
	Flush mounting	✓	Red	T5-9-SOND*/EA/SVB	908029	✓	
	Flush mounting	✓	Black	T5-9-SOND*/EA/SVB-SW	907987	✓	
	Rear mounting	✓	Red	T5-9-SOND*/V/SVB	908030	✓	

**Note:** Please use the 'Ordering non-standard contact sequences' order form when ordering for the first time. When placing repeat orders, specify the contact sequence number together (e.g. 47110GB).

Product standards	UL508, CSA - C22-2 No 14-05, IEC/EN 60947-3, CE Marking
UL File No	E36332
UL CCN	NLRV7
CSA File No	12528
CSA Class No	3211-05
NA Certification	UL Listed, CSA Certified

# Non standard Cam switches and Switch-disconnectors

## TM Non-standard switches - SOND-ERSTBESTELLUNG

For new orders with a completed form

Rated current	Number of contact chambers	Mounting option	Main switch	Part number	Article number	Suitable for export to North America (US and Canada)
10 A	1	Flush mounting		TM-1-SOND-ERSTBESTELLUNG/E	208261	✓
	1	Centre mounting		TM-1-SOND-ERSTBESTELLUNG/EZ	208262	✓
	1	Service distribution board		TM-1-SOND-ERSTBESTELLUNG/IVS	225347	✓
	2	Flush mounting		TM-2-SOND-ERSTBESTELLUNG/E	208263	✓
	2	Centre mounting		TM-2-SOND-ERSTBESTELLUNG/EZ	208264	✓
	2	Service distribution board		TM-2-SOND-ERSTBESTELLUNG/IVS	225349	✓
	3	Flush mounting		TM-3-SOND-ERSTBESTELLUNG/E	208265	✓
	3	Centre mounting		TM-3-SOND-ERSTBESTELLUNG/EZ	208266	✓
	4	Flush mounting		TM-4-SOND-ERSTBESTELLUNG/E	208267	✓
	4	Centre mounting		TM-4-SOND-ERSTBESTELLUNG/EZ	208268	✓
	5	Flush mounting		TM-5-SOND-ERSTBESTELLUNG/E	208269	✓
	5	Centre mounting		TM-5-SOND-ERSTBESTELLUNG/EZ	208270	✓
	6	Flush mounting		TM-6-SOND-ERSTBESTELLUNG/E	208271	✓
	6	Centre mounting		TM-6-SOND-ERSTBESTELLUNG/EZ	208272	✓
	7	Flush mounting		TM-7-SOND-ERSTBESTELLUNG/E	208273	✓
	7	Centre mounting		TM-7-SOND-ERSTBESTELLUNG/EZ	208274	✓
	8	Flush mounting		TM-8-SOND-ERSTBESTELLUNG/E	208275	✓
	8	Centre mounting		TM-8-SOND-ERSTBESTELLUNG/EZ	208276	✓

## TM Non-standard switches - SOND

For repeat orders for which the design number is already known Form F02 is not required for this purpose. The design number is a six-digit number and must always be greater than 200000.

Rated current	Number of contact chambers	Mounting option	Main switch	Part number	Article number	Suitable for export to North America (US and Canada)
10 A	1	Flush mounting		TM-1-SOND*/E	907749	✓
	2	Flush mounting		TM-2-SOND*/E	907763	✓
	3	Flush mounting		TM-3-SOND*/E	907750	✓
	4	Flush mounting		TM-4-SOND*/E	907751	✓
	5	Flush mounting		TM-5-SOND*/E	907764	✓
	6	Flush mounting		TM-6-SOND*/E	907752	✓
	7	Flush mounting		TM-7-SOND*/E	907753	✓
	8	Flush mounting		TM-8-SOND*/E	907754	✓
	1	Centre mounting		TM-1-SOND*/E	907755	✓
	2	Centre mounting		TM-2-SOND*/EZ	907756	✓
	3	Centre mounting		TM-3-SOND*/EZ	907757	✓
	4	Centre mounting		TM-4-SOND*/EZ	907758	✓
	5	Centre mounting		TM-5-SOND*/EZ	907759	✓
	6	Centre mounting		TM-6-SOND*/EZ	907760	✓
	7	Centre mounting		TM-7-SOND*/EZ	907761	✓
	8	Centre mounting		TM-8-SOND*/EZ	907762	✓
	1	Service distribution board		TM-1-SOND*/IVS	225346	✓
	2	Service distribution board		TM-2-SOND*/IVS	225348	✓

Product standards	UL508, CSA - C22-2 No 14-05, IEC/EN 60947-3, CE Marking
UL File No	E36332
UL CCN	NLRV, NLRV7
CSA File No	UL report applies to both US and Canada
CSA Class No	-
NA Certification	UL report applies to both US and Canada
Degree of protection	IEC: IP65, UL/CSA Type: -

# Non standard Cam switches and Switch-disconnectors

## Ordering of non standard contact sequences

Switch size	Number of contacts units (2 contacts per contact unit)		Contact sequence number	Mounting form	Accessories
	Max units	Contacts max.			
T0	11	22	With country ID corresponding to the country of manufacture. Send completed forms (as shown page 175) if ordering for the first time. The contact sequence number is specified by the supplying factory. Specifying the part no is enough when placing repeat orders.	Flush mounting: /E	Always specify completely for every order
T3	11	22		Centre mounting: /EZ (for T0, T3)	
T5B	10	20		Surface mounting: /I <sup>(1)</sup>	For TM.../EZ only +EZ/S possible
T5	10	20		Service distribution board mounting: /IVS (for T0)	
TM	8	16		Rear mounting: /Z	
				Flush mounting main switch EA/SVB <sup>(2)</sup>	
			Surface mounting main switch: L./SVB		
			Rear mounting main switch: /V/SVB <sup>(2)</sup>		
			Designs for: TM: /E/EZ or /IVS		

### Contact sequence

The adjacent form makes it easier to specify the contact sequence.

### Switching angle

30, 45, 60, 90°

Preferred angle: 60°

For On-Off switches: 90°

For main switches: 90° as FS 908

Changeover with interruption between 2 positions (ON-OFF-ON) not permissible for T0, T3 and TM = 30°, 45°; for T5 (T5B) = 30°

Star delta switch only with switching angle ≥ 60°

### Terminal marking

TM switches have consecutive terminal markings starting with 1.

### Automatic (spring) return

The switching action is limited by a stop. The switch returns under spring pressure to the last position. Where a switch has Automatic (spring) return from both directions, a maximum of max. 3 positions can be traversed.

The Automatic (spring) return angle is ≤ ½ switching angle. A max of 6 contacts can be returned at the same time.

The switching angle of Automatic (spring) return TM mini rotary switch must be ≥ 60°.

### Fleeting contacts

The duration of the fleeting contact depends primarily on the actuation speed. In order to actuate a contactor with a fleeting pulse, the switching angle of the cam switch must not be less than 60°, since the pulse time can be too short if the switching angle is smaller. Fleeting contact elements always cooperate in **both** operating directions.

### Complete rotation

Only possible with a total switching angle at 360° the direction of switching can be either operating direction. The number of switch position multiplied by the switching angle must be 360°, TM with 12 positions (one every 30°) only available with complete rotation, not with stop.

### Front plates

Front plates are part of the equipment supplied with a 'first order of rotary switch' and therefore do **not** need to be ordered separately.

### Number of contact units

Number of contact/2 = Round up to nearest whole number

The number chamber = contact unit (BE) has 1 or 2 contacts, each of which is actuated by a cam.

In T5(B) there is a common cam for both contacts. Because of this, the following applies for T5(B): If the total switching angle is **less than 180°**, the contacts can be switched **independently** of each other. With switching angles for greater than or equal to 180°, there can only be 2 contacts in the same chamber, if their switching sequences are the same but are offset by 180° (e.g. TS5-4-8235 step switch)

### Standard features

Same as cam switch with standard contact sequence.

**Note:** It is possible that the order of the contacts is altered due to technical reasons. For special switches, bridges are only possible between an even or uneven number. Other connections must be made by the user installation.

(1)	For T0.../I1 max 4 contact units For T3.../I2 max 5 contact units
(2)	For T0 up to a max 8 contact = 4 BE For T3: up to a max. of 12 contacts = 6 BE

# Non standard Cam switches and Switch-disconnectors

## Non-standard contact sequence ordering example



Binding document for ordering T cam switch combinations for the first time

Order No.: <b>123456</b>	Item: <b>7</b>	Office: <b>Cologne</b>	Author: <b>HWS</b>																																																
Customer: <b>Sample Company</b>		Customer no.: <b>A4711/2004</b>	Date: <b>29.2.2004</b>																																																
Quantity: <b>3</b>	Switching angle:	Part no.:	Number of contacts:																																																
Euros/unit:	<input type="checkbox"/> 30 <input type="checkbox"/> 45 <input type="checkbox"/> 60 <input type="checkbox"/> 90	<input type="checkbox"/> TM <input type="checkbox"/> T0 <input type="checkbox"/> T3 <input type="checkbox"/> T5B <input type="checkbox"/> T5	<input type="checkbox"/> 1 <input type="checkbox"/> 2 <input type="checkbox"/> 3 <input type="checkbox"/> 4 <input type="checkbox"/> 5 <input type="checkbox"/> 6 <input type="checkbox"/> 7 <input type="checkbox"/> 8 <input type="checkbox"/> 9 <input type="checkbox"/> 10 <input type="checkbox"/> 11																																																
			<input type="checkbox"/> 12 <input type="checkbox"/> 13 <input type="checkbox"/> 14 <input type="checkbox"/> 15 <input type="checkbox"/> 16 <input type="checkbox"/> 17 <input type="checkbox"/> 18 <input type="checkbox"/> 19 <input type="checkbox"/> 20 <input type="checkbox"/> 21 <input type="checkbox"/> 22																																																
			Mounting form: <input type="checkbox"/> E <input type="checkbox"/> EA/SVB <input type="checkbox"/> EZ <input type="checkbox"/> I... <input type="checkbox"/> I../SVB <input type="checkbox"/> IVS <input type="checkbox"/> V/SVB <input type="checkbox"/> Z <input type="checkbox"/> + ST-0 <input type="checkbox"/> + _____																																																
<table border="1" style="width:100%; border-collapse: collapse;"> <tr> <td>Max. characters per position</td> <td>TM-E</td> <td>TM-EZ</td> <td>TM-IVS</td> <td>T0(3)</td> <td>T5(B)</td> </tr> <tr> <td>Degrees</td> <td></td> <td></td> <td></td> <td></td> <td></td> </tr> <tr> <td>0.18</td> <td>5</td> <td>5</td> <td>6</td> <td>13</td> <td>13</td> </tr> <tr> <td>30, 210, 330</td> <td>8</td> <td>7</td> <td>4</td> <td>8</td> <td>8</td> </tr> <tr> <td>45, 135, 225, 315</td> <td>6</td> <td>5</td> <td>4</td> <td>6</td> <td>7</td> </tr> <tr> <td>60, 120, 240, 300</td> <td>5</td> <td>5</td> <td>3</td> <td>5</td> <td>7</td> </tr> <tr> <td>90, 270</td> <td>5</td> <td>4</td> <td>1</td> <td>4</td> <td>7</td> </tr> <tr> <td>150</td> <td>4</td> <td>4</td> <td>4</td> <td>8</td> <td>8</td> </tr> </table>				Max. characters per position	TM-E	TM-EZ	TM-IVS	T0(3)	T5(B)	Degrees						0.18	5	5	6	13	13	30, 210, 330	8	7	4	8	8	45, 135, 225, 315	6	5	4	6	7	60, 120, 240, 300	5	5	3	5	7	90, 270	5	4	1	4	7	150	4	4	4	8	8
Max. characters per position	TM-E	TM-EZ	TM-IVS	T0(3)	T5(B)																																														
Degrees																																																			
0.18	5	5	6	13	13																																														
30, 210, 330	8	7	4	8	8																																														
45, 135, 225, 315	6	5	4	6	7																																														
60, 120, 240, 300	5	5	3	5	7																																														
90, 270	5	4	1	4	7																																														
150	4	4	4	8	8																																														

<b>Front plate no.</b>  <b>FS</b>  <input type="radio"/> Complete rotation  <input type="radio"/> Automatic spring-return    <b>Insription</b>	<table border="1" style="width:100%; border-collapse: collapse;"> <tr> <th colspan="2">Contact units</th> <th>1</th><th>2</th><th>3</th><th>4</th><th>5</th><th>6</th><th>7</th><th>8</th><th>9</th><th>10</th><th>11</th> </tr> <tr> <td colspan="2"></td> <td>1</td><td>3</td><td>5</td><td>7</td><td>9</td><td>11</td><td>13</td><td>15</td><td>17</td><td>19</td><td>21</td><td>23</td><td>25</td><td>27</td><td>29</td><td>31</td><td>33</td><td>35</td><td>37</td><td>39</td><td>41</td><td>43</td> </tr> <tr> <td colspan="2"></td> <td>2</td><td>4</td><td>6</td><td>8</td><td>10</td><td>12</td><td>14</td><td>16</td><td>18</td><td>20</td><td>22</td><td>24</td><td>26</td><td>28</td><td>30</td><td>32</td><td>34</td><td>36</td><td>38</td><td>40</td><td>42</td><td>44</td> </tr> <tr> <td colspan="2"></td> <td colspan="23"> </td> </tr> </table>	Contact units		1	2	3	4	5	6	7	8	9	10	11			1	3	5	7	9	11	13	15	17	19	21	23	25	27	29	31	33	35	37	39	41	43			2	4	6	8	10	12	14	16	18	20	22	24	26	28	30	32	34	36	38	40	42	44																																																																																																																																																																																																																																																																																																																																																										
Contact units		1	2	3	4	5	6	7	8	9	10	11																																																																																																																																																																																																																																																																																																																																																																																																												
		1	3	5	7	9	11	13	15	17	19	21	23	25	27	29	31	33	35	37	39	41	43																																																																																																																																																																																																																																																																																																																																																																																																	
		2	4	6	8	10	12	14	16	18	20	22	24	26	28	30	32	34	36	38	40	42	44																																																																																																																																																																																																																																																																																																																																																																																																	
<b>Degrees</b>	<table border="1" style="width:100%; border-collapse: collapse;"> <tr> <th></th> <th>1</th><th>3</th><th>5</th><th>7</th><th>9</th><th>11</th><th>13</th><th>15</th><th>17</th><th>19</th><th>21</th><th>23</th><th>25</th><th>27</th><th>29</th><th>31</th><th>33</th><th>35</th><th>37</th><th>39</th><th>41</th><th>43</th> </tr> <tr> <th>270</th> <td>1</td><td>X</td><td>X</td><td>X</td><td>X</td><td>X</td><td></td><td>X</td><td></td><td></td><td></td><td></td><td></td><td></td><td></td><td></td><td></td><td></td><td></td><td></td><td></td><td></td><td></td> </tr> <tr> <th>300</th> <td></td><td></td><td></td><td></td><td></td><td></td><td></td><td></td><td></td><td></td><td></td><td></td><td></td><td></td><td></td><td></td><td></td><td></td><td></td><td></td><td></td><td></td><td></td> </tr> <tr> <th>315</th> <td></td><td></td><td></td><td></td><td></td><td></td><td></td><td></td><td></td><td></td><td></td><td></td><td></td><td></td><td></td><td></td><td></td><td></td><td></td><td></td><td></td><td></td><td></td> </tr> <tr> <th>330</th> <td>2</td><td>X</td><td>X</td><td>X</td><td></td><td></td><td></td><td>X</td><td></td><td></td><td></td><td></td><td></td><td></td><td></td><td></td><td></td><td></td><td></td><td></td><td></td><td></td><td></td> </tr> <tr> <th>0</th> <td></td><td></td><td></td><td></td><td></td><td>X</td><td></td><td></td><td></td><td></td><td></td><td></td><td></td><td></td><td></td><td></td><td></td><td></td><td></td><td></td><td></td><td></td><td></td> </tr> <tr> <th>30</th> <td>3</td><td>X</td><td></td><td></td><td>X</td><td>X</td><td></td><td></td><td></td><td></td><td></td><td></td><td></td><td></td><td></td><td></td><td></td><td></td><td></td><td></td><td></td><td></td><td></td> </tr> <tr> <th>45</th> <td></td><td></td><td></td><td></td><td></td><td></td><td></td><td></td><td></td><td></td><td></td><td></td><td></td><td></td><td></td><td></td><td></td><td></td><td></td><td></td><td></td><td></td><td></td> </tr> <tr> <th>60</th> <td>4</td><td></td><td></td><td></td><td></td><td></td><td></td><td></td><td>X</td><td></td><td></td><td></td><td></td><td></td><td></td><td></td><td></td><td></td><td></td><td></td><td></td><td></td><td></td> </tr> <tr> <th>90</th> <td></td><td></td><td></td><td></td><td></td><td></td><td></td><td></td><td></td><td></td><td></td><td></td><td></td><td></td><td></td><td></td><td></td><td></td><td></td><td></td><td></td><td></td><td></td> </tr> <tr> <th>120</th> <td></td><td></td><td></td><td></td><td></td><td></td><td></td><td></td><td></td><td></td><td></td><td></td><td></td><td></td><td></td><td></td><td></td><td></td><td></td><td></td><td></td><td></td><td></td> </tr> <tr> <th>135</th> <td></td><td></td><td></td><td></td><td></td><td></td><td></td><td></td><td></td><td></td><td></td><td></td><td></td><td></td><td></td><td></td><td></td><td></td><td></td><td></td><td></td><td></td><td></td> </tr> <tr> <th>150</th> <td></td><td></td><td></td><td></td><td></td><td></td><td></td><td></td><td></td><td></td><td></td><td></td><td></td><td></td><td></td><td></td><td></td><td></td><td></td><td></td><td></td><td></td><td></td> </tr> <tr> <th>180</th> <td></td><td></td><td></td><td></td><td></td><td></td><td></td><td></td><td></td><td></td><td></td><td></td><td></td><td></td><td></td><td></td><td></td><td></td><td></td><td></td><td></td><td></td><td></td> </tr> <tr> <th>210</th> <td></td><td></td><td></td><td></td><td></td><td></td><td></td><td></td><td></td><td></td><td></td><td></td><td></td><td></td><td></td><td></td><td></td><td></td><td></td><td></td><td></td><td></td><td></td> </tr> <tr> <th>225</th> <td></td><td></td><td></td><td></td><td></td><td></td><td></td><td></td><td></td><td></td><td></td><td></td><td></td><td></td><td></td><td></td><td></td><td></td><td></td><td></td><td></td><td></td><td></td> </tr> <tr> <th>240</th> <td></td><td></td><td></td><td></td><td></td><td></td><td></td><td></td><td></td><td></td><td></td><td></td><td></td><td></td><td></td><td></td><td></td><td></td><td></td><td></td><td></td><td></td><td></td> </tr> </table>		1	3	5	7	9	11	13	15	17	19	21	23	25	27	29	31	33	35	37	39	41	43	270	1	X	X	X	X	X		X																300																								315																								330	2	X	X	X				X																0						X																		30	3	X			X	X																		45																								60	4								X															90																								120																								135																								150																								180																								210																								225																								240																							
	1	3	5	7	9	11	13	15	17	19	21	23	25	27	29	31	33	35	37	39	41	43																																																																																																																																																																																																																																																																																																																																																																																																		
270	1	X	X	X	X	X		X																																																																																																																																																																																																																																																																																																																																																																																																																
300																																																																																																																																																																																																																																																																																																																																																																																																																								
315																																																																																																																																																																																																																																																																																																																																																																																																																								
330	2	X	X	X				X																																																																																																																																																																																																																																																																																																																																																																																																																
0						X																																																																																																																																																																																																																																																																																																																																																																																																																		
30	3	X			X	X																																																																																																																																																																																																																																																																																																																																																																																																																		
45																																																																																																																																																																																																																																																																																																																																																																																																																								
60	4								X																																																																																																																																																																																																																																																																																																																																																																																																															
90																																																																																																																																																																																																																																																																																																																																																																																																																								
120																																																																																																																																																																																																																																																																																																																																																																																																																								
135																																																																																																																																																																																																																																																																																																																																																																																																																								
150																																																																																																																																																																																																																																																																																																																																																																																																																								
180																																																																																																																																																																																																																																																																																																																																																																																																																								
210																																																																																																																																																																																																																																																																																																																																																																																																																								
225																																																																																																																																																																																																																																																																																																																																																																																																																								
240																																																																																																																																																																																																																																																																																																																																																																																																																								
<b>Key withdrawable</b> X	<table border="1" style="width:100%; border-collapse: collapse;"> <tr> <td style="width:20%;"></td> <td style="width:60%;">Part no. for repeat orders (to be filled in by factory)</td> <td style="width:20%;"><b>T</b></td> </tr> </table>		Part no. for repeat orders (to be filled in by factory)	<b>T</b>																																																																																																																																																																																																																																																																																																																																																																																																																				
	Part no. for repeat orders (to be filled in by factory)	<b>T</b>																																																																																																																																																																																																																																																																																																																																																																																																																						

# Non standard Cam switches and Switch-disconnectors

Binding document for initial orders for T rotary switch combinations

Order number:		Item:		Office:		Name:		
Customer:				Customer number:			Date:	

Note: The number of possible contacts, as well as the possible combinations with mounting forms are shown in the Main Catalogue.	Quantity:	Switching angle:	Type:	No. of contacts:	Mounting form:
	Euro/each:	<input type="checkbox"/> 30 <input type="checkbox"/> 45 <input type="checkbox"/> 60 <input type="checkbox"/> 90	<input type="checkbox"/> TM <input type="checkbox"/> T0 <input type="checkbox"/> T3 <input type="checkbox"/> T5B <input type="checkbox"/> T5	<input type="checkbox"/> 1 <input type="checkbox"/> 12 <input type="checkbox"/> 2 <input type="checkbox"/> 13 <input type="checkbox"/> 3 <input type="checkbox"/> 14 <input type="checkbox"/> 4 <input type="checkbox"/> 15 <input type="checkbox"/> 5 <input type="checkbox"/> 16 <input type="checkbox"/> 6 <input type="checkbox"/> 17 <input type="checkbox"/> 7 <input type="checkbox"/> 18 <input type="checkbox"/> 8 <input type="checkbox"/> 19 <input type="checkbox"/> 9 <input type="checkbox"/> 20 <input type="checkbox"/> 10 <input type="checkbox"/> 21 <input type="checkbox"/> 11 <input type="checkbox"/> 22	<input type="checkbox"/> E <input type="checkbox"/> EA/SVB <input type="checkbox"/> EA/SVB-SW <input type="checkbox"/> EZ <input type="checkbox"/> I... <input type="checkbox"/> I.../SVB <input type="checkbox"/> I.../SVB-SW <input type="checkbox"/> IVS <input type="checkbox"/> V/SVB <input type="checkbox"/> V/SVB-SW <input type="checkbox"/> XZ <input type="checkbox"/> Z <input type="checkbox"/> + _____ <input type="checkbox"/> + _____

Degrees	TM-E	TM-EZ	TM-IVS	T0(3)	T5(B)
0	5	5	6	13	13
30, 210, 330	8	7	4	8	8
45, 135, 225, 315	6	5	4	6	7
60, 120, 240, 300	5	5	3	5	7
90, 270	5	4	1	4	7
150	4	4	4	8	8
180	5	5	6	7	13

Front plate no. <b>FS</b>	Contact units																																																																																																																																																																																																																																																																																																																																																																																																																							
<input type="checkbox"/> Complete rotation <input type="checkbox"/> Spring-return	<table border="1" style="width: 100%; border-collapse: collapse;"> <tr> <th>1</th><th>2</th><th>3</th><th>4</th><th>5</th><th>6</th><th>7</th><th>8</th><th>9</th><th>10</th><th>11</th> </tr> <tr> <td>1</td><td>3</td><td>5</td><td>7</td><td>9</td><td>11</td><td>13</td><td>15</td><td>17</td><td>19</td><td>21</td><td>23</td><td>25</td><td>27</td><td>29</td><td>31</td><td>33</td><td>35</td><td>37</td><td>39</td><td>41</td><td>43</td> </tr> <tr> <td>2</td><td>4</td><td>6</td><td>8</td><td>10</td><td>12</td><td>14</td><td>16</td><td>18</td><td>20</td><td>22</td><td>24</td><td>26</td><td>28</td><td>30</td><td>32</td><td>34</td><td>36</td><td>38</td><td>40</td><td>42</td><td>44</td> </tr> </table>	1	2	3	4	5	6	7	8	9	10	11	1	3	5	7	9	11	13	15	17	19	21	23	25	27	29	31	33	35	37	39	41	43	2	4	6	8	10	12	14	16	18	20	22	24	26	28	30	32	34	36	38	40	42	44																																																																																																																																																																																																																																																																																																																																																																
1	2	3	4	5	6	7	8	9	10	11																																																																																																																																																																																																																																																																																																																																																																																																														
1	3	5	7	9	11	13	15	17	19	21	23	25	27	29	31	33	35	37	39	41	43																																																																																																																																																																																																																																																																																																																																																																																																			
2	4	6	8	10	12	14	16	18	20	22	24	26	28	30	32	34	36	38	40	42	44																																																																																																																																																																																																																																																																																																																																																																																																			
<table border="1" style="width: 100%; border-collapse: collapse;"> <tr> <th>Degrees</th> <th>Inscription</th> <th>1</th><th>3</th><th>5</th><th>7</th><th>9</th><th>11</th><th>13</th><th>15</th><th>17</th><th>19</th><th>21</th><th>23</th><th>25</th><th>27</th><th>29</th><th>31</th><th>33</th><th>35</th><th>37</th><th>39</th><th>41</th><th>43</th> </tr> <tr> <td>270</td><td></td><td>2</td><td>4</td><td>6</td><td>8</td><td>10</td><td>12</td><td>14</td><td>16</td><td>18</td><td>20</td><td>22</td><td>24</td><td>26</td><td>28</td><td>30</td><td>32</td><td>34</td><td>36</td><td>38</td><td>40</td><td>42</td><td>44</td> </tr> <tr><td>300</td><td></td><td></td><td></td><td></td><td></td><td></td><td></td><td></td><td></td><td></td><td></td><td></td><td></td><td></td><td></td><td></td><td></td><td></td><td></td><td></td><td></td><td></td><td></td></tr> <tr><td>315</td><td></td><td></td><td></td><td></td><td></td><td></td><td></td><td></td><td></td><td></td><td></td><td></td><td></td><td></td><td></td><td></td><td></td><td></td><td></td><td></td><td></td><td></td><td></td></tr> <tr><td>330</td><td></td><td></td><td></td><td></td><td></td><td></td><td></td><td></td><td></td><td></td><td></td><td></td><td></td><td></td><td></td><td></td><td></td><td></td><td></td><td></td><td></td><td></td><td></td></tr> <tr><td>0</td><td></td><td></td><td></td><td></td><td></td><td></td><td></td><td></td><td></td><td></td><td></td><td></td><td></td><td></td><td></td><td></td><td></td><td></td><td></td><td></td><td></td><td></td><td></td></tr> <tr><td>30</td><td></td><td></td><td></td><td></td><td></td><td></td><td></td><td></td><td></td><td></td><td></td><td></td><td></td><td></td><td></td><td></td><td></td><td></td><td></td><td></td><td></td><td></td><td></td></tr> <tr><td>45</td><td></td><td></td><td></td><td></td><td></td><td></td><td></td><td></td><td></td><td></td><td></td><td></td><td></td><td></td><td></td><td></td><td></td><td></td><td></td><td></td><td></td><td></td><td></td></tr> <tr><td>60</td><td></td><td></td><td></td><td></td><td></td><td></td><td></td><td></td><td></td><td></td><td></td><td></td><td></td><td></td><td></td><td></td><td></td><td></td><td></td><td></td><td></td><td></td><td></td></tr> <tr><td>90</td><td></td><td></td><td></td><td></td><td></td><td></td><td></td><td></td><td></td><td></td><td></td><td></td><td></td><td></td><td></td><td></td><td></td><td></td><td></td><td></td><td></td><td></td><td></td></tr> <tr><td>120</td><td></td><td></td><td></td><td></td><td></td><td></td><td></td><td></td><td></td><td></td><td></td><td></td><td></td><td></td><td></td><td></td><td></td><td></td><td></td><td></td><td></td><td></td><td></td></tr> <tr><td>135</td><td></td><td></td><td></td><td></td><td></td><td></td><td></td><td></td><td></td><td></td><td></td><td></td><td></td><td></td><td></td><td></td><td></td><td></td><td></td><td></td><td></td><td></td><td></td></tr> <tr><td>150</td><td></td><td></td><td></td><td></td><td></td><td></td><td></td><td></td><td></td><td></td><td></td><td></td><td></td><td></td><td></td><td></td><td></td><td></td><td></td><td></td><td></td><td></td><td></td></tr> <tr><td>180</td><td></td><td></td><td></td><td></td><td></td><td></td><td></td><td></td><td></td><td></td><td></td><td></td><td></td><td></td><td></td><td></td><td></td><td></td><td></td><td></td><td></td><td></td><td></td></tr> <tr><td>210</td><td></td><td></td><td></td><td></td><td></td><td></td><td></td><td></td><td></td><td></td><td></td><td></td><td></td><td></td><td></td><td></td><td></td><td></td><td></td><td></td><td></td><td></td><td></td></tr> <tr><td>225</td><td></td><td></td><td></td><td></td><td></td><td></td><td></td><td></td><td></td><td></td><td></td><td></td><td></td><td></td><td></td><td></td><td></td><td></td><td></td><td></td><td></td><td></td><td></td></tr> <tr><td>240</td><td></td><td></td><td></td><td></td><td></td><td></td><td></td><td></td><td></td><td></td><td></td><td></td><td></td><td></td><td></td><td></td><td></td><td></td><td></td><td></td><td></td><td></td><td></td></tr> </table>	Degrees	Inscription	1	3	5	7	9	11	13	15	17	19	21	23	25	27	29	31	33	35	37	39	41	43	270		2	4	6	8	10	12	14	16	18	20	22	24	26	28	30	32	34	36	38	40	42	44	300																								315																								330																								0																								30																								45																								60																								90																								120																								135																								150																								180																								210																								225																								240																							
Degrees	Inscription	1	3	5	7	9	11	13	15	17	19	21	23	25	27	29	31	33	35	37	39	41	43																																																																																																																																																																																																																																																																																																																																																																																																	
270		2	4	6	8	10	12	14	16	18	20	22	24	26	28	30	32	34	36	38	40	42	44																																																																																																																																																																																																																																																																																																																																																																																																	
300																																																																																																																																																																																																																																																																																																																																																																																																																								
315																																																																																																																																																																																																																																																																																																																																																																																																																								
330																																																																																																																																																																																																																																																																																																																																																																																																																								
0																																																																																																																																																																																																																																																																																																																																																																																																																								
30																																																																																																																																																																																																																																																																																																																																																																																																																								
45																																																																																																																																																																																																																																																																																																																																																																																																																								
60																																																																																																																																																																																																																																																																																																																																																																																																																								
90																																																																																																																																																																																																																																																																																																																																																																																																																								
120																																																																																																																																																																																																																																																																																																																																																																																																																								
135																																																																																																																																																																																																																																																																																																																																																																																																																								
150																																																																																																																																																																																																																																																																																																																																																																																																																								
180																																																																																																																																																																																																																																																																																																																																																																																																																								
210																																																																																																																																																																																																																																																																																																																																																																																																																								
225																																																																																																																																																																																																																																																																																																																																																																																																																								
240																																																																																																																																																																																																																																																																																																																																																																																																																								

Key withdrawable		Type for re-ordering (to be filled in by factory) <b>T</b>
------------------	--	--



<b>EATON</b>		Binding document for initial orders of non-standard front plates	
Order number:	Item:		
Office:	Name:		
Customer:	Customer number:		
Quantity:	Euro/each:	Date:	

The text is always centered in the text box

## Non-Standard Front Plates

Inscription:

Front plate with black lettering

Insert Text

Note: The maximum number of characters allowed outside the marked areas!

Type Non-standard front plate T0, T3 or P1

FS-SOND-ERSTBESTELLUNG-T0  
(SAP-Nr: 225355)

Height of  $\leq 2$  characters 4 mm  
letters  $\geq 2$  characters 3 mm

Type Non-standard front plate T5B, T5 or P3

FS-SOND-ERSTBESTELLUNG-P3  
(SAP-Nr: 225356)

Height of  $\leq 2$  characters 8 mm  
letters  $\geq 2$  characters 5 mm

Type Non-standard front plate TM/E

TM/E-FRONTSCHILD-NR(\*)  
(SAP-Nr: 239021)

Type Non-standard front plate TM/EZ

TM/EZ-FRONTSCHILD-NR(\*)  
(SAP-Nr: 239022)

Height of  $\leq 2$  characters 3,5 mm  
letters  $\geq 2$  characters 3 mm

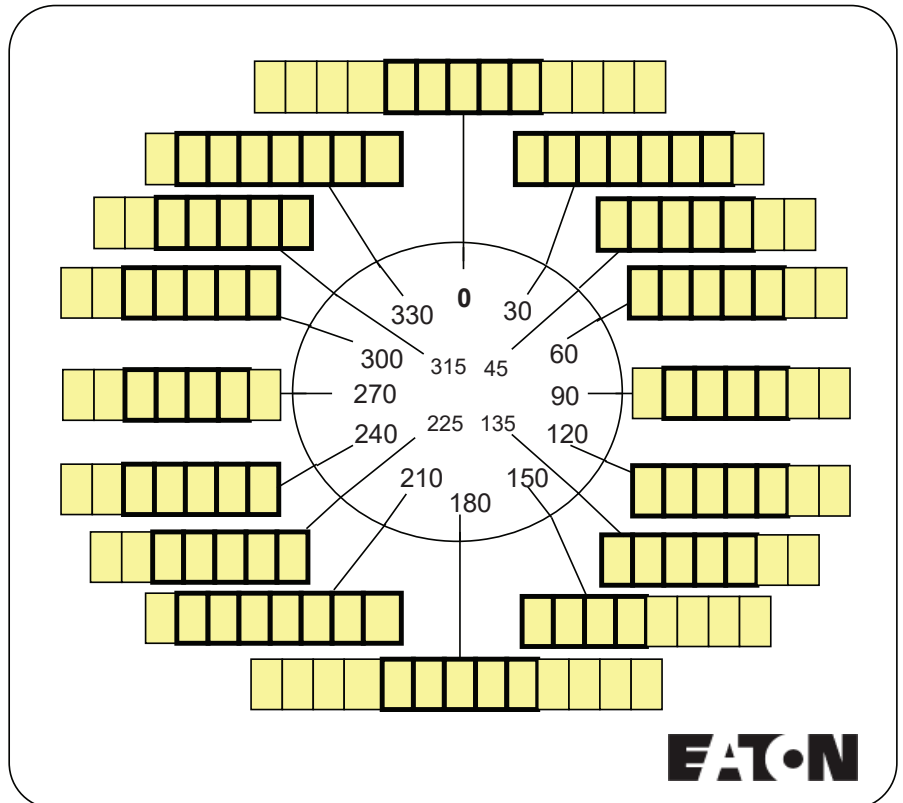

For P1 and P3 complete only the 270° and 0° positions

Maximal numbers of characters possible position

Degrees	TM-E	TM-EZ	T0/P1	T5/P3
0	5	5	13	13
30, 210, 330	8	7	8	8
45, 135, 225, 315	6	5	6	7
60, 120, 240, 300	5	5	5	7
90, 270	5	4	4	7
150	4	4	8	8
180	5	5	7	13

Dimensions

Type	Size of front plate
TM-.../E	29 x 29 mm (for frame size 30 x 30)
TM-.../EZ	29 x 29 mm (for frame size 30 x 30)
T0, T3, P1	45 x 45 mm (for frame size 48 x 48)
T5B, T5, P3	84 x 84 mm (for frame size 88 x 88)

Type for re-ordering (to be fill in by factory)

**FS**

## P Switch-disconnectors standards

Product group	IEC 60947-1	IEC 60947-3	CE Marking	UKCA Marking	Degree of protection		NA Certification	UL FILE No.	UL CCN			
					IEC	UL/ CSA			NLRV	NLRV7	UL 489	UL 508
P1 - ... /E	✓	✓	✓	✓	IP65	1, 12	UL Listed, CSA Certified	E36332	✓	X	X	X
P1 - ... /EZ	✓	✓	✓	✓	IP65	1, 12	UL Listed, CSA Certified	E36332	✓	X	X	X
P1 - ... /Z	✓	✓	✓	✓	IP65	1, 12	UL Listed, CSA Certified	E36332	✓	X	X	X
P1 - ... /M4	✓	✓	✓	✓	IP65	1, 12	UL Listed, CSA Certified	E36332	✓	X	X	X
P1 - ... /SVB(-SW)	✓	✓	✓	✓	IP65	1, 12	UL Listed, CSA Certified	E36332	✓	X	X	X
P1 - ... /IVS	✓	✓	✓	✓	IP30	-	UL Listed, CSA Certified	E36332	✓	X	X	X
P1 - ... /I1	✓	✓	✓	✓	IP65	-	X	X	X	X	X	X
P1 - ... /I1H	✓	✓	✓	✓	IP65	-	X	X	X	X	X	X
P1 - ... /I2	✓	✓	✓	✓	IP65	1, 12	UL Listed, CSA Certified	E36332	✓	X	X	X
P1 - ... /I2H	✓	✓	✓	✓	IP65	-	X	X	X	X	X	X
P1 - ... /... -SI(-SW)	✓	✓	✓	✓	IP65	-	X	X	X	X	X	X
P1 - ... /SE1	✓	✓	✓	✓	IP65	-	X	X	X	X	X	X
P3 - ... /E	✓	✓	✓	✓	IP65	1	UL Listed, CSA Certified	E36332	✓	X	X	X
P3 - ... /Z	✓	✓	✓	✓	IP65	1	UL Listed, CSA Certified	E36332	✓	X	X	X
P3 - ... /M4	✓	✓	✓	✓	IP65	1	UL Listed, CSA Certified	E36332	✓	X	X	X
P3 - ... /IVS	✓	✓	✓	✓	IP30	1	UL Listed, CSA Certified	E36332	✓	X	X	X
P3 - ... /SVB(-SW)	✓	✓	✓	✓	IP65	1, 12	UL Listed, CSA Certified	E36332	✓	X	X	X
P3 - ... /I3	✓	✓	✓	✓	IP65	-	X	X	X	X	X	X
P3 - ... /I4	✓	✓	✓	✓	IP65	1, 12	UL Listed, CSA Certified	E36332	✓	X	X	X
P3 - ... /I5	✓	✓	✓	✓	IP65	1, 12	UL Listed, CSA Certified	E36332	✓	X	X	X
P3 - ... /... -SI	✓	✓	✓	✓	IP65	-	X	X	X	X	X	X
P3 - ... /SE3	✓	✓	✓	✓	IP65	-	X	X	X	X	X	X
P3-30/...-MCS	X	X	X	X	X	X	X	X	X	X	✓	X
P5 - ... /E	✓	✓	✓	✓	IP65	12	UL Listed, CSA Certified	E36332	✓	✓	X	✓
P5 - ... /Z	✓	✓	✓	✓	IP65	12	UL Listed, CSA Certified	E36332	✓	✓	X	✓
P5 - ... /SVB(-SW)	✓	✓	✓	✓	IP65	12	UL Listed, CSA Certified	E36332	✓	✓	X	✓

### Notes:

All switch-disconnectors comply to IEC 62061-1

All switch-disconnectors with emergency switch off/emergency stop function comply to IEC 60204-1

## P Switch-disconnectors standards

Product group	UL 60947-1	UL 60947-4-1	CSA FILE No.	CSA Class No.		CSA 60947-1-13	CSA 60947-4-1-14	CSA C22.2 No. 0-10	CSA 22.2 14-10	CSA 22.2 14-13	Suitable for	
				3211-25	3211-05						Branch circuits	Motor disconnect
P1 - ... /E	✓	✓	012528	✓	✓	✓	✓	✓	X	✓	✓	✓
P1 - ... /EZ	✓	✓	012528	✓	✓	✓	✓	✓	X	✓	✓	✓
P1 - ... /Z	✓	✓	012528	✓	✓	✓	✓	✓	X	✓	✓	✓
P1 - ... /M4	✓	✓	012528	✓	✓	✓	✓	✓	X	✓	✓	✓
P1 - ... /SVB(-SW)	✓	✓	012528	✓	✓	✓	✓	✓	X	✓	✓	✓
P1 - ... /IVS	✓	✓	012528	✓	✓	✓	✓	✓	X	✓	✓	X
P1 - ... /I1	X	X	X	X	X	X	X	X	X		X	X
P1 - ... /I1H	X	X	X	X	X	X	X	X	X	X	X	X
P1 - ... /I2	✓	✓	012528	✓	✓	✓	✓	✓		✓	✓	✓
P1 - ... /I2H	X	X	X	X	X	X	X	X	X	X	X	X
P1 - ... /... -SI(-SW)	X	X	X	X	X	X	X	X	X	X	X	X
P1 - ... /SE1	X	X	X	X	X	X	X	X	X	X	X	X
P3 - ... /E	✓	✓	012528	✓	✓	✓	✓	✓	X	✓	✓	✓
P3 - ... /Z	✓	✓	012528	✓	✓	✓	✓	✓	X	✓	✓	✓
P3 - ... /M4	✓	✓	012528	✓	✓	✓	✓	✓	X	✓	✓	✓
P3 - ... /IVS	✓	✓	012528	✓	✓	✓	✓	✓	X	✓	✓	
P3 - ... /SVB(-SW)	✓	✓	012528	✓	✓	✓	✓	✓	X	✓	✓	✓
P3 - ... /I3	X	X	X	X	X	X	X	X	X	X	X	X
P3 - ... /I4	✓	✓	012528	✓	✓	✓	✓	✓	X	✓	✓	✓
P3 - ... /I5	✓	✓	012528	✓	✓	✓	✓	✓	X	✓	✓	✓
P3 - ... /... -SI	X	X	X	X	X	X	X	X	X	X	X	X
P3 - ... /SE3	X	X	X	X	X	X	X	X	X	X	X	X
P3-30/...-MCS	X	X	X	X	X	X	X	X	X	X	X	X
P5 - ... /E	X	X	223805	X	✓	X	X	X	✓	X	✓	✓
P5 - ... /Z	X	X	223805	X	✓	X	X	X	✓	X	✓	✓
P5 - ... /SVB(-SW)	X	X	223805	X	✓	X	X	X	✓	X	✓	✓

### Notes:

All switch-disconnectors comply to IEC 62061-1

All switch-disconnectors with emergency switch off/emergency stop function comply to IEC 60204-1

## T Rotary cam switch-disconnectors standards

Product group	IEC 60947-1	IEC 60947-3	CE Marking	UKCA Marking	Degree of protection		NA Certification	UL FILE No.	UL CCN		
					IEC	UL/ CSA			NLRV	NLRV7	UL 508
TM - ... /E	✓	✓	✓	✓	IP65	-	UL Listed, Certified for UL use in Canada	E36332	✓	X	✓
TM - ... /EZ	✓	✓	✓	✓	IP65	-	UL Listed, Certified for UL use in Canada	E36332	✓	X	✓
TM - ... /IVS	✓	✓	✓	✓	IP30	-	UL Listed, Certified for UL use in Canada	E36332	✓	X	✓
T0 - ... /E	✓	✓	✓	✓	IP65	1, 12	UL Listed, CSA Certified	E36332	✓	X	X
T0 - ... /EZ	✓	✓	✓	✓	IP65	1, 12	UL Listed, CSA Certified	E36332	✓	X	X
T0 - ... /Z	✓	✓	✓	✓	IP65	1, 12	UL Listed, CSA Certified	E36332	✓	X	X
T0 - ... /IVS	✓	✓	✓	✓	IP30	-	UL Listed, CSA Certified	E36332	✓	X	X
T0 - ... /I1	✓	✓	✓	✓	IP65	-	X	X	X	X	X
T0 - ... /I1H	✓	✓	✓	✓	IP65	-	X	X	X	X	X
T0 - ... /I2	✓	✓	✓	✓	IP65	1, 12	UL Listed, CSA Certified	E36332	✓	X	X
T0 - ... /I2H	✓	✓	✓	✓	IP65	-	X	X	X	X	X
T0 - ... /SVB(-SW)	✓	✓	✓	✓	IP65	1, 12	UL Listed, CSA Certified	E36332	✓	X	X
T3 - ... /E	✓	✓	✓	✓	IP65	1, 12	UL Listed, CSA Certified	E36332	✓	X	X
T3 - ... /EZ	✓	✓	✓	✓	IP65	1, 12	UL Listed, CSA Certified	E36332	✓	X	X
T3 - ... /Z	✓	✓	✓	✓	IP65	1, 12	UL Listed, CSA Certified	E36332	✓	X	X
T3 - ... /SVB(-SW)	✓	✓	✓	✓	IP65	1, 12	UL Listed, CSA Certified	E36332	✓	X	X
T3 - ... /I2	✓	✓	✓	✓	IP65	1, 12	UL Listed, CSA Certified	E36332	✓	X	X
T3 - ... /I2H	✓	✓	✓	✓	IP65	-	X	X	X	X	X
T5(B) - ... /E	✓	✓	✓	✓	IP65	1	UL Listed, CSA Certified	E36332	✓	X	X
T5(B) - ... /Z	✓	✓	✓	✓	IP65	1	UL Listed, CSA Certified	E36332	✓	X	X
T5(B) - ... /I	✓	✓	✓	✓	IP65	1, 12	UL Listed, CSA Certified	E36332	✓	X	X
T5(B) - ... /SVB(-SW)	✓	✓	✓	✓	IP65	1, 12	UL Listed, CSA Certified	E36332	✓	X	X
T6 - ... /E	✓	✓	✓	✓	IP65	X	Contact BuleTechnical@Eaton.com for more information	X	X	X	X
T6 - ... /SVB(-SW)	✓	✓	✓	✓	IP65	X		X	X	X	X
T6 - ... /I45	✓	✓	✓	✓	IP65	X		X	X	X	X
T8 - ... /E	✓	✓	✓	✓	IP65	X-		X	X	X	X
T8 - ... /SVB(-SW)	✓	✓	✓	✓	IP65	X		X	X	X	X
T6 - ... /I48	✓	✓	✓	✓	IP65	X		X	X	X	X

**Notes:**

All switch-disconnectors comply to IEC 62061-1

All switch-disconnectors with emergency switch off/emergency stop function comply to IEC 60204-1

## T Rotary cam switch-disconnectors standards

Product group	UL 60947-1	UL 60947-4-1	CSA FILE No.	CSA Class No.		CSA 60947-1-13	CSA 60947-4-1-14	CSA C22.2 No. 0-10	CSA 22.2 14-10	CSA 22.2 14-13	Suitable for	
				3211-25	3211-05						Branch circuits	Motor disconnect
TM - ... /E	X	X	UL report applies to both US and Canada	X	X	X	X	X	✓	X	X	X
TM - ... /EZ	X	X		X	X	X	X	X	✓	X	X	X
TM - ... /IVS	X	X		X	X	X	X	X	✓	X	X	X
T0 - ... /E	✓	✓	012528	✓	✓	✓	✓	✓	X	✓	✓	✓
T0 - ... /EZ	✓	✓	012528	✓	✓	✓	✓	✓	X	✓	✓	✓
T0 - ... /Z	✓	✓	012528	✓	✓	✓	✓	✓	X	✓	✓	✓
T0 - ... /IVS	✓	✓	012528	✓	✓	✓	✓	✓	X	✓	✓	X
T0 - ... /I1	X	X	X	X	X	X	X	X	X	X	X	X
T0 - ... /I1H	X	X	X	X	X	X	X	X	X	X	X	X
T0 - ... /I2	✓	✓	012528	✓	✓	✓	✓	✓	X	✓	✓	✓
T0 - ... /I2H	X	X	X	X	X	X	X	X	X	X	X	X
T0 - ... /SVB(-SW)	✓	✓	012528	✓	✓	✓	✓	✓	X	✓	✓	✓
T3 - ... /E	✓	✓	012528	✓	✓	✓	✓	✓	X	✓	✓	✓
T3 - ... /EZ	✓	✓	012528	✓	✓	✓	✓	✓	X	✓	✓	✓
T3 - ... /Z	✓	✓	012528	✓	✓	✓	✓	✓	X	✓	✓	✓
T3 - ... /SVB(-SW)	✓	✓	012528	✓	✓	✓	✓	✓	X	✓	✓	✓
T3 - ... /I2	✓	✓	012528	✓	✓	✓	✓	✓	X	✓	✓	✓
T3 - ... /I2H	X	X	X	X	X	X	X	X	X	X	X	X
T5(B) - ... /E	✓	✓	012528	✓	✓	✓	✓	✓	X	✓	✓	✓
T5(B) - ... /Z	✓	✓	012528	✓	✓	✓	✓	✓	X	✓	✓	✓
T5(B) - ... /I	✓	✓	012528	✓	✓	✓	✓	✓	X	✓	✓	✓
T5(B) - ... /SVB(-SW)	✓	✓	012528	✓	✓	✓	✓	✓	X	✓	✓	✓
T6 - ... /E	X	X	X	X	X	X	X	X	X	X	X	X
T6 - ... /SVB(-SW)	X	X	X	X	X	X	X	X	X	X	X	X
T6 - ... /I45	Contact buletechnical@eaton.com for more information											
T8 - ... /E	Contact buletechnical@eaton.com for more information											
T8 - ... /SVB(-SW)	Contact buletechnical@eaton.com for more information											
T6 - ... /I48	Contact buletechnical@eaton.com for more information											

### Notes:

All switch-disconnectors comply to IEC 62061-1

All switch-disconnectors with emergency switch off/emergency stop function comply to IEC 60204-1

# Characteristic curves

Component lifespan based on breaking current and utilisation category AC-3 and AC-21 at 400 V a.c., AC-15 at 230 V.

To ensure a reasonable service life in utilisation category AC-4 (extreme load: 100% inching, reversing or plug braking) the motor's standstill current must not exceed the rated operational current of the switch AC-21A.

## T0 - Characteristic curve

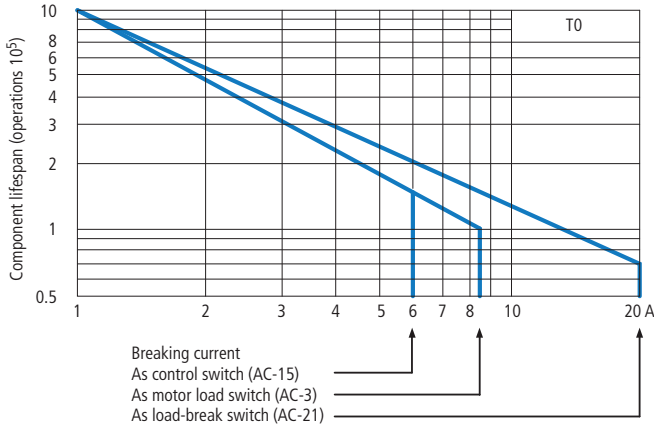

## T3 - Characteristic curve

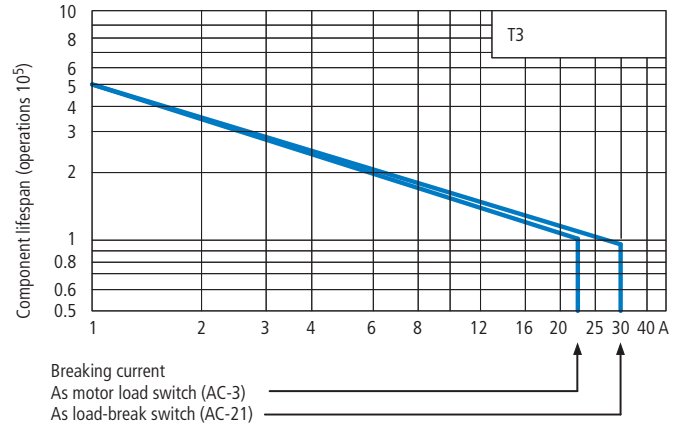

## T5, T5B - Characteristic curve

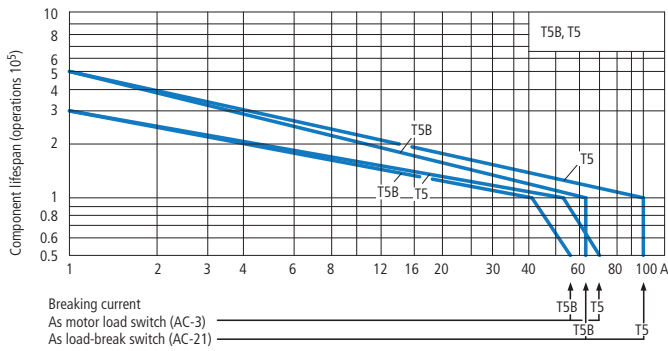

## T6, T8 - Characteristic curve

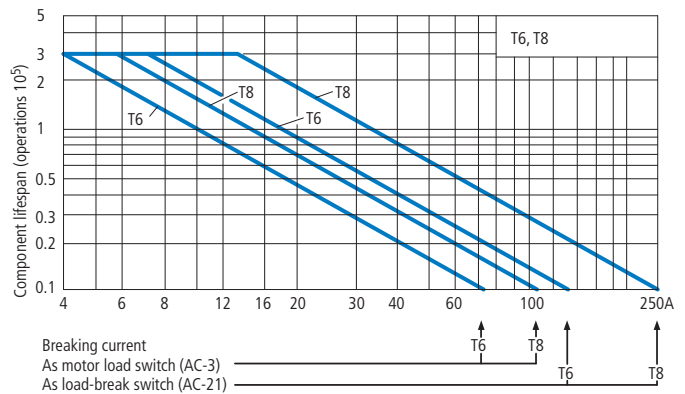

## P1 - Characteristic curve

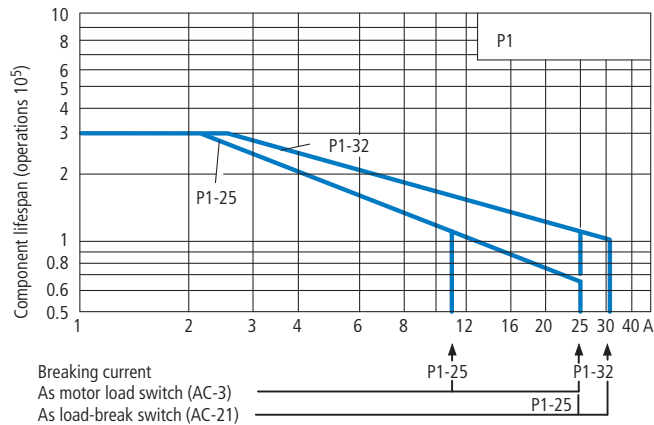

## P3 - Characteristic curve

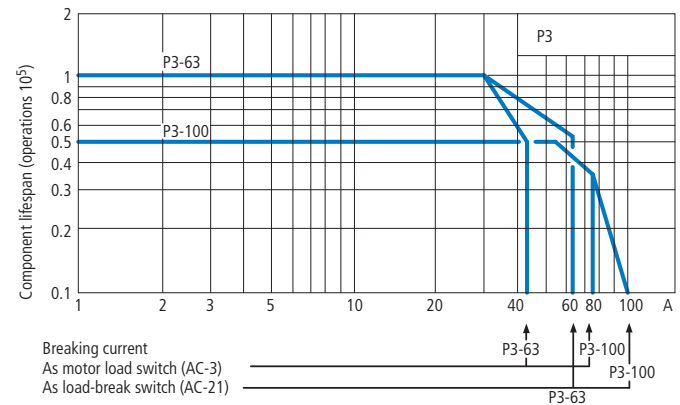

# Technical data

## P1 and P3 Switch-disconnectors

			P1-25	P1-32	P1-40	P3-63	P3-100
<b>General</b>							
Standards			IEC/EN 60947, VDE 0660, IEC/EN 60204, CSA, UL, switch-disconnector to IEC/EN 60947-3		IEC/EN 60947, IEC/EN 60204	IEC/EN 60947, VDE 0660, IEC/EN 60204, CSA, UL, switch-disconnector to IEC/EN 60947-3	
Lifespan mechanical	Operations	$\times 10^5$	0.3	0.3	0.3	0.1	0.1
Maximum operating frequency	Operations/h		50	50	50	50	50
Climatic proofing			Damp heat, constant to IEC 60068-2-78 Damp heat, cyclical to IEC 60068-2-30				
Ambient temperature (for derating information contact <a href="mailto:buletechnical@eaton.com">buletechnical@eaton.com</a> )	Open	°C	-25 - 50	-25 - 50	-25 - 50	-25 - 50	-25 - 50
	Enclosed	°C	-25 - 40	-25 - 40	-25 - 40	-25 - 40	-25 - 40
Mounting position			Any	Any	Any	Any	Any
Mechanical shock resistance (IEC/EN 600068-2-27)	Half-sinusoidal shock 20 ms	g	15	15	15	15	15

### Contacts

Rated operational voltage	$U_e$	V A C	690	690	690	690	690	
Rated impulse withstand voltage	$U_{imp}$	V A C	6000	6000	6000	6000	6000	
Overvoltage category/pollution degree			III/3	III/3	III/3	III/3	III/3	
Rated uninterrupted current	$I_u$	A	25	32	40	63	100	
Load rating with intermittent operation, class 12	AB 60% DF	$\times I_e$	1.3	1.3	1.3	1.3	1.3	
	AB 40% DF	$\times I_e$	1.6	1.6	1.6	1.6	1.6	
	AB 25% DF	$\times I_e$	2	2	2	2	2	
Short-circuit rating	Fuse	A gG/gL	25	50	50	80	100	
Rated conditional short-circuit current	Load side	$I_q$	kA	50	80	80	4	4
	Supply side	$I_q$	kA	-	-	-	100	80
Rated short-time withstand current (1s current)	$I_{cw}$	$A_{rms}$	640	640	640	1260	1260	
Isolating characteristics to IEC/EN 60947			V A C	$\leq 690$	$\leq 690$	$\leq 690$	$\leq 690$	$\leq 690$
Safe isolation according to EN 61140								
Safe isolation to VDE 0106 Part 101 and Part 101 A1 between the auxiliary contacts and main circuits			VAC	440	440	440	440	440
Switching angle			°	90	90	90	90	90
Contacts			Number	Max. 3 (+N)	Max. 3 (+N)	Max. 3 (+N)	Max. 3 (+N)	Max. 3 (+N)
Current heat loss per contact at $I_e$			W	1.1	1.8	1.9	4.5	7.5

### Terminal capacity

Solid or stranded		mm <sup>2</sup>	1 x (1.5-6) 2 x (1.5-6)	1 x (1.5-6) 2 x (1.5-6)	1 x (1.5-10) 2 x (1.5-10)	1 x (2.5-35) 2 x (2.5-10)	1 x (2.5-35) 2 x (2.5-10)
Flexible with ferrule to DIN 46228		mm <sup>2</sup>	1 x (1-4) 2 x (1-4)	1 x (1-4) 2 x (1-4)	1 x (1-4) 2 x (1-4)	1 x (1.5-25) 2 x (1.5-6)	1 x (1.5-25) 2 x (1.5-6)
Fork terminal			-	-	1 x (1.5-10) 2 x (1.5-10)	-	-
Terminal screw			M4	M4	M4	M5	M5
Tightening torque		Nm	1.6	1.6	1.6	3	3

### Switching capacity

AC Voltage								
Rated making capacity $\cos \varphi = 0.35$ *P1-40 $\varphi = 0.45$		A	240	320	360*	800	950	
Rated breaking capacity, motor load switch $\cos \varphi = 0.35$	230 V	A	190	260	X	640	760	
	400/415 V	A	150	300	290*	600	740	
*P1-40 $\varphi = 0.45$	500 V	A	170	290	X	590	880	
	690 V	A	150	250	130*	340	520	
Rated operational current 440V, load-break switch AC-21A	$I_e$	A	25	32	40	63	100	
AC-3 motor load switch motor load	230 V	P	kW	5.5	7.5	7.5	15	22
	400/415 V	P	kW	7.5	13	15	30	37
	500 V	P	kW	7.5	18.5	X	30	45
	690 V	P	kW	7.5	15	15	30	37

**Notes:** Main switch characteristics to IEC/EN 60204; positive opening of contacts, operator element positively located on shaft. Rated uninterrupted current  $I_u$  is specified for max cross-section. For terminal capacity solid, stranded and flexible: Max. 2 cross-section sizes difference admissible when using 2 conductors.

# Technical data

## P1 and P3 Switch-disconnectors

					P1-25	P1-32	P1-40	P3-63	P3-100
<b>Switching capacity</b>									
AC-23A motor load switch motor load	230 V	P	kW	7	8.5	11	18.5	30	
	400/415 V	P	kW	13	15	22	30	50	
	500 V	P	kW	11	18.5	X	37	65	
	690 V	P	kW	11	18.5	18.5	30	45	

### DC Voltage

DC-1, load switch L/R = 1 ms	Rated operational current	$I_e$	A	25	32	X	63	100	
	Voltage per contact connected in series		V	60	60	X	60	60	
DC-23A, motor load switch L/R = 15 ms	24 V	Rated operational current	$I_e$	A	25	25	X	50	50
		Contacts	Number	1	1	X	1	1	
	48 V	Rated operational current	$I_e$	A	25	25	X	50	50
		Contacts	Number	2	2	X	2	2	
	60 V	Rated operational current	$I_e$	A	25	25	X	50	50
		Contacts	Number	3	3	X	3	3	
	120 V	Rated operational current	$I_e$	A	12	12	X	25	25
		Contacts	Number	3	3	X	3	3	

### Rating data for approved types UL File No E36332 (Devices for world markets IEC, UL/CSA)

#### Contacts

Rated operational voltage $U_e$		V a.c.	600	600	600	600	600
Rated operational current $I_u$	Rated current	A	20	30	40	60	100
	Pilot duty		A 600 P 600	A 600 P 600	A 600 P 600	-	-

#### Switching capacity

AC-3: max, rated power, 40-60 Hz AC motors

3-phase	200 V a.c.	HP	5	7½	X	15	20
	230 V a.c.	HP	5	10	X	15	25
	460 V a.c.	HP	10	20	X	40	60
	575 V a.c.	HP	15	25	X	50	75
Single-phase	200 V a.c.	HP	1½	2	X	3	5
	230 V a.c.	HP	3	3	X	7½	10
	460 V a.c.	HP	3	5	X	10	15

#### Short-circuit rating

Standard	600 V a.c.	kA	5	5	5	10	10
		A	110	110	110	150	150
		Part no.	NZMH6	NZMH6	NZMH6	NZMH6	NZMH6
		A	125	125	125	125	125
Disconnect in motor circuits	600 V a.c.	kA	10	10	10	10	-
		Class	50 A/J	50 A/J	50 A/J	100 A	100 A

#### Terminal capacity

Terminal capacity	Cu cable	Min./	AWG	14	14	14	14	14
		Max	AWG	8	8	8	2	2
Tightening torque		Max	in-lb	14.1	14.1	14.1	26.5	26.5

#### H1 11

#### Auxiliary contacts (1 N/O + 1 N/C)

Pilot duty	P 600
Heavy pilot duty	A 600
General use	10 A - 600 V AC



# Technical data

## P5 Switch-disconnectors

			P5-125	P5-160	P5-250	P5-315	
<b>General</b>							
Standards			IEC/EN 60947, VDE 0660, IEC/EN 60204, CSA, UL switch-disconnector to IEC/EN 60947-3				
Lifespan mechanical	Operations	x 10 <sup>6</sup>	0.1	0.1	0.08	0.08	
Maximum operating frequency	Operations/h		50	50	50	50	
Climatic proofing			Damp heat, constant to IEC 60068-2-78 Damp heat, cyclical to IEC 60068-2-30				
Ambient temperature (for derating information contact buletechnical@eaton.com)	Open	°C	-25 - 50	-25 - 50	-25 - 50	-25 - 50	
	Enclosed	°C	-25 - 40	-25 - 40	-25 - 40	-25 - 40	
Mounting position			Any	Any	Any	Any	
<b>Contacts</b>							
Rated operational voltage		U <sub>e</sub>	V A C	690	690	690	690
Rated impulse withstand voltage		U <sub>imp</sub>	V A C	8000	8000	8000	8000
Overvoltage category/pollution degree				III/3	III/3	III/3	III/3
Rated uninterrupted current		I <sub>u</sub>	A	125	160	250	315
Load rating with intermittent operation, class 12	AB 60% DF		x I <sub>e</sub>	1.3	1.3	1.3	1.3
	AB 40% DF		x I <sub>e</sub>	1.6	1.6	1.6	1.6
	AB 25% DF		x I <sub>e</sub>	2	2	2	2
Short-circuit rating	Fuse		A gG/gL	125	160	250	315
Rated conditional short-circuit current	Load side	I <sub>q</sub>	kA	30	30	30	15
	Supply side	I <sub>q</sub>	kA	-	-	-	-
Rated short-time withstand current (1s current)		I <sub>cw</sub>	A <sub>rms</sub>	2500	3000	4600	5800
Isolating characteristics to IEC/EN 60947			V A C	≤ 690	≤ 690	≤ 690	≤ 690
Safe isolation according to EN 61140							
Safe isolation to VDE 0106 Part 101 and Part 101 A1 between the auxiliary contacts and main circuits			VAC	440	440	440	440
Switching angle			°	90	90	90	90
Contacts			Number	Max. 3 (+N)	Max. 3 (+N)	Max. 3 (+N)	Max. 3 (+N)
Current heat loss per contact at I <sub>e</sub>			W	8	10	13	16
<b>Terminal capacity</b>							
Solid or stranded			mm <sup>2</sup>	1 x (10-95) 2 x (10-35)	1 x (10-95) 2 x (10-35)	1 x (16-185) 2 x (16-70)	1 x (10-95) 2 x (10-35)
Copper strip. 1 flat conductor	Number of layers x width x thickness		mm	6 x 9 x 0.8	-	6 x 20 x 1	-
Copper strip. 2 flat conductors			mm	-	6 x 9 x 0.8	-	6 x 20 x 1
Flexible with ferrule to DIN 46228			mm <sup>2</sup>	1 x (16-70) 2 x (16-25)	1 x (16-70) 2 x (16-25)	1 x (25-120) 2 x (25-50)	1 x (25-120) 2 x (25-50)
Terminal screw				Hexagon screw 5		Hexagon screw 6	
Tightening torque			Nm	14	14	16	16
	400/415 V	P	kW	13	15	30	50
	500 V	P	kW	11	18.5	37	65
	690 V	P	kW	11	18.5	30	45

**Notes:** Main switch characteristics to IEC/EN 60204; positive opening of contacts, operator element positively located on shaft. Rated uninterrupted current I<sub>u</sub> is specified for max cross-section. For terminal capacity solid, stranded and flexible: Max. 2 cross-section sizes difference admissible when using 2 conductors.

## P5 Switch-disconnectors

				P5-125	P5-160	P5-250	P5-315	
<b>Switching capacity</b>								
AC Voltage								
Rated making capacity $\cos \varphi = 0.35$			A	850	1050	1700	2050	
Rated breaking capacity, motor load switch $\cos \varphi = 0.35$	230 V		A	800	900	1600	1800	
	400/415 V		A	750	850	1380	1650	
	500 V		A	650	850	1250	1550	
	690 V		A	340	340	400	400	
Rated operational current 440V, load-break switch AC-21A		$I_e$	A	125	160	250	315	
AC-3 motor load switch motor load	230 V	P	kW	22	30	37	45	
	400 V	P	kW	37	45	55	75	
	690 V	P	kW	30	37	45	45	
AC-23A motor load switch motor load	230 V	P	kW	30	30	37	55	
	400 V	P	kW	45	55	90	110	
	690 V	P	kW	37	37	45	45	
DC Voltage								
DC-1, load switch L/R = 1 ms	Rated operational current	$I_e$	A	125	160	250	315	
	Voltage per contact connected in series		V	42	42	42	42	
DC-23A, motor load switch L/R = 15 ms	24 V	Rated operational current	$I_e$	A	125	160	250	315
		Voltage per contact connected in series		Number	3	3	3	3
	48 V	Rated operational current	$I_e$	A	125	160	250	315
		Contacts		Number	3	3	3	3
	60 V	Rated operational current	$I_e$	A	125	160	250	315
		Contacts		Number	3	3	3	3
120 V	Rated operational current	$I_e$	A	125	160	250	315	
	Contacts		Number	3	3	3	3	

**Notes:** Main switch characteristics to IEC/EN 60204; positive opening of contacts, operator element positively located on shaft. Rated uninterrupted current  $I_u$  is specified for max cross-section. For terminal capacity solid, stranded and flexible: Max. 2 cross-section sizes difference admissible when using 2 conductors.

				HI...-P1(P3)...	HI...-P5...
<b>Auxiliary contacts</b>					
Standards	Control circuit isolator to IEC/EN 60947-5				
Rated insulation voltage	$U_i$	V AC		500	500
Rated uninterrupted current	$I_u$	A		10	10
Rated operational current					
AC-15 at 230 V	$I_e$	A		6	6
	400 V / 415 V	$I_e$	A	-	-
DC-13	125 V	$I_e$	A	1.1	0.23
	250 V	$I_e$	A	0.55	0.1
Short-circuit training					
Max fuse	A	gG/gL		10	10
Terminal capacity					
Solid		$mm^2$		1 x 0.75 - 2.5 2 x 0.75 - 1.5	1 x 0.75 - 2.5 2 x 0.75 - 1.5
	Flexible with ferrule to DIN 46228	$mm^2$		1 x 0.5 - 1.5 2 x 0.5 - 1.5	1 x 0.5 - 1.5 2 x 0.5 - 1.5
Tightening torque		Nm		0.6	0.8
Control circuit reliability at 24 V d.c., 10 mA		$H_f$		< 10 <sup>-5</sup> , < 1 failure for 100,000 switching operations	

## P5 Switch-disconnectors

			P5-125	P5-160	P5-250	P5-315	
<b>Rating data for approved types UL File No E36332</b>							
<b>Contacts</b>							
Rated operational voltage	$U_e$		600	600	600	600	
Rated impulse withstand voltage <sup>(1)</sup>	$U_{imp}$	V a.c.	8000	8000	8000	8000	
Rated uninterrupted current <sup>(2)</sup>	$I_u$	A	125	160	250	300	
Rated operational current							
Ampere rating	Off switch	$I_e$	A	125	160	250	300
	Changeover switches	$I_e$	A	125	160	X	X
Non inductive and slightly inductive loads							
Rated switching duty							
DOL rating (similar to AC-3)							
3-phase, 3-pole							
	120 V		HP	15	20	30	40
	240 V		HP	30	40	60	75
	480 V		HP	60	60	75	100
	600 V		HP	60	60	75	100
Short-circuit rating							
Max back-up fuse, gL characteristics			A	125	160	250	315
Rated short-time withstand current (1s current)			A	2500	3000	4600	5000
Terminal capacity							
Cu cable							
Solid or stranded for box terminal			AWG	3/0	3/0	X	X
			MCM	X	X	350	350
Flexible without ferrule			AWG	2/0	2/0	X	X
			MCM	X	X	300	300
Connection with cable lug or busbar				M10 x	M10 x	M10 x	M10 x
Terminal screw				20	20	20	20
Max. width				20	20	20	20
Max width with terminal cover				25	25	25	25
Ambient temperature		Open on 100% $I_u/I_{th}$		50°C over 24 hours with peaks up to 55°C			
		Enclosed on 100% $I_{the}$		35°C over 24 hours with peaks up to 40°C			

(1) Valid for mains with grounded star point, overvoltage category III, pollution degree 3

(2) Valid for connection with cable for 75°C

			HI11	HI21-P5-125(160)	HI21-P5-250(315)
<b>Auxiliary contacts</b>					
Standards					
Rated uninsulated voltage	$U_i$	V a.c.		600	600
Rated uninterrupted current	$I_u$	A		10	10
Rated operational current	$I_e$				
Pilot duty			P600	P600	P600
Heavy pilot duty			A600	A600	A600
General use			10 A - 600 V a.c.		
Ampere rating					
Non inductive and slightly inductive loads			-	10	10
Short-circuit rating					
Max. fuse	gL characteristic	A	-	16	16
Terminal capacity					
Solid or stranded		AWG	-	12	12
Flexible without ferrule		AWG	-	14	14

Devices for world markets IEC, UL/CSA

# Technical data

## TM Mini cam switches

				TM
<b>General</b>				
Standards		IEC/EN 60947, VDE 0660, CSA, UL Control switch to IEC/EN 60947-5-1 Control circuit isolators to IEC/EN 60947-5-1		
Control circuit isolator (IEC/EN 60947-5-1)		Max 6 contacts, switching angle 90°		
Lifespan mechanical	Operations	x 10 <sup>6</sup>	>1	
Maximum operating frequency	Operations/h	3000		
Climatic proofing		Damp heat, constant to IEC 60068-2-78; Damp heat, cyclic to IEC 60068-2-30		
Ambient temperature (for derating information contact buletechnical@eaton.com)		Open	°C	-25 -50
		Enclosed	°C	-25 -40
Mounting position		Any		
<b>Contacts</b>				
Mechanical data				
Contacts		Number	Max. 16	
Contacts units (BE)			Max 8	
Switching angle		°	90, 60, 45, 30	
Smallest switching angle for ON-OFF-ON		°	60	
Max switch position		≤	≤12	
Electrical characteristics				
Rated operational voltage		U <sub>e</sub>	V a.c.	500
Rated impulse withstand voltage		U <sub>imp</sub>	V a.c.	4000
Overvoltage category/pollution degree				III/3
Rated insulation voltage		U <sub>i</sub>	V a.c.	500
Rated insulation voltage to UL/CSA			V a.c.	300
Rated conditional short-circuit current	Load side	I <sub>q</sub>	kA	0
	Supply side	I <sub>q</sub>	kA	-
Rated uninterrupted current		I <sub>u</sub>	A	10
Switching capacity				
AC-23 motor load switch	230 V a.c.	3-pole	kW	1.8
	440 V a.c.	3-pole	kW	3
	230 V a.c.	1-pole	kW	0.75
	440 V a.c.	1-pole	kW	1.1
AC-15 control switch	230 V a.c.	1-pole	A	2.5
	400 V a.c.	1-pole	A	1.5
	440 V a.c.	1-pole	A	1
DC-13, control switch L/R = 50 ms	Rated operational current I <sub>e</sub>		I <sub>e</sub> A	3
	Voltage per contact connected in series		V	32
Switching capacity (UL489, CSA 22.2 No 5.1)	240 V a.c.	3-pole	HP	1
	277 V a.c.	1-pole	HP	¾
	300 V a.c.	Heavy-duty	A	10
Max short-circuit protection device				
Fuse		A	gG/gL	10
<b>Terminal capacity</b>				
Solid or stranded			mm <sup>2</sup>	1 x 1.5 2 x 1.5
Flexible without ferrule			mm <sup>2</sup>	1 x 1.5 2 x 1.5
Solid or stranded			AWG	1 x 14 2 x 14
Flexible			AWG	1 x 16 2 x 16
Terminal screw				M2.5
Tightening torque			Nm	0.35

# Technical data

## T0, T3, T5B, T5 Cam switch-disconnectors

			T0...	T3...	T5B...	T5...	
<b>General</b>							
Standards			IEC/EN 60947, VDE 0660, IEC/EN 60204, CSA, UL switch-disconnector to IEC/EN 60947-3 Load break switch according to IEC/EN60947-3				
Lifespan mechanical	Operations	x 10 <sup>6</sup>	0.5	0.5	0.5	0.5	
Maximum operating frequency	Operations/h		3000	3000	3000	3000	
Climatic proofing			Damp heat, constant to IEC 60068-2-78; Damp heat, cyclic to IEC 60068-2-30				
Ambient temperature (for derating information contact buletechnical@eaton.com)	Open	°C	-25 -50	-25 -50	-25 -50	-25 -50	
	Enclosed	°C	-25 -40	-25 -40	-25 -40	-25 -40	
Mounting position			Any	Any	Any	Any	
Mechanical shock resistance to IEC 60068-2-27	Half-sinusoidal shock to 20 ms	g	>15	>15	>15	>15	
<b>Contacts</b>							
Rated operational voltage	U <sub>e</sub>	V A C	690	690	690	690	
Rated impulse withstand voltage	U <sub>imp</sub>	V A C	6000	6000	6000	6000	
Overvoltage category/pollution degree			III/3	III/3	III/3	III/3	
Rated uninterrupted current	Open	I <sub>u</sub>	A	20	32	63	100
	Enclosed	I <sub>u</sub>	A	20	32	63	100
Load rating with intermittent operation, class 12	AB 60% DF	x I <sub>e</sub>	2	2	2	2	
	AB 40% DF	x I <sub>e</sub>	1.6	1.6	1.6	1.6	
	AB 25% DF	x I <sub>e</sub>	1.3	1.3	1.3	1.3	
Rated conditional short-circuit current	Load side	I <sub>q</sub>	kA	6	1	2	2
	Supply side	I <sub>q</sub>	kA	-	-	-	-
Short-circuit rating	Fuse		A gG/gL	20	35	80	100
Rated short-time withstand current (1s current)	I <sub>cw</sub>	A <sub>rms</sub>	320	650	1300	1850	
Safe isolation according to EN 61140							
Between the contacts			VAC	440	440	440	440
Switching angle			°	90 60 45 30	90 60 45 30	90 60 45 30	90 60 45 30
Contact units			Number	Max. 11	Max. 11	Max. 10	Max. 10
Contacts with double-break				Max. 22	Max. 22	Max. 20	Max. 20
Current heat loss per contact at I <sub>e</sub>			W	0.6	1.1	4.5	7.5
<b>Terminal capacity</b>							
Solid or stranded			mm <sup>2</sup>	1 x (1-2.5) 2 x (1-2.5)	1 x (1-2.5) 2 x (1-2.5)	1 x (2.5-35) 2 x (2.5-16)	1 x (2.5-35) 2 x (2.5-16)
Flexible with ferrule to DIN 46228			mm <sup>2</sup>	1 x (0.75-1.5) 2 x (0.75-1.5)	1 x (0.75-4) 2 x (0.75-4)	1 x (1.5-25) 2 x (1.5-10)	1 x (1.5-25) 2 x (1.5-10)
Terminal screw				M3.5	M4	M6	M6
Tightening torque			Nm	1	2	4	4

**Notes:** The following applies for mechanical shock resistance: T3.../I...>12g.

Applies to T0.../SVB: isolating characteristics to IEC/EN 60947 for rated operational voltage U<sub>e</sub> up to 500 V a.c.

The following applies to rated uninterrupted current I<sub>u</sub> of contacts: max 95 A with T5-4-8344/I5.

The following applies to solid, stranded and flexible terminal capacities:

T0, , (8)...: If 2 conductors are used, a max difference of 2 cross-section sizes is permissible.

T5(B)-...: If 2 conductors are used, a max difference of 1 cross-section sizes is permissible.

The following applies for part no T8-3-8342/...: switching angle = 90° and flat conductor connection = 1 flat conductor.

25 x 5 or 2 flat conductors, 20 x 3

## T0, T3, T5B and T5 Cam switch-disconnectors

				T0-...	T3-...	T5B-...	T5-...	
<b>Switching capacity</b>								
AC Voltage								
Rated making capacity $\cos \varphi = 0.35$			A	130	320	800	960	
Rated breaking capacity, motor load switch $\cos \varphi = 0.35$	230 V		A	100	260	520	760	
	400 V		A	110	260	600	740	
	500 V		A	80	240	480	590	
	690 V		A	60	170	340	420	
Rated operational current, load-break switch AC-21A	440 V	$I_e$	A	20	32	63	100	
Motor rating Motor load switch AC-3	230 V	P	kW	3	6.5	15	22	
	230 V star-delta	P	kW	4	11	22	30	
	400/415 V	P	kW	4	12	22	30	
	400 V star-delta	P	kW	5.5	18.5	37	45	
	500 V	P	kW	5.5	15	22	37	
	500 V star-delta	P	kW	7.5	22	37	55	
	690 V	P	kW	4	15	22	30	
	690 V star-delta	P	kW	5.5	22	37	45	
Motor rating Motor load switch AC-23A	230 V	P	kW	3.5	7.5	15	18.5	
	400/415 V	P	kW	6.5	13	22	30	
	500 V	P	kW	7.5	15	22	37	
	690 V	P	kW	6.5	15	22	30	
Motor rating Motor load switch AC-15	230 V	P	kW	6	10	16	16	
	400/415 V	P	kW	4	6	6	6	
	500 V	P	kW	2	4	4	4	
DC Voltage								
DC-1, load switch L/R = 1 ms	Rated operational current	$I_e$	A	10	25	63	80	
	Voltage per contact connected in series		V	60	60	60	60	
DC-21A	Rated operational current 240 V		A	1	1			
	240 V contacts		Number	1	1			
DC-23A, motor load switch L/R = 15 ms	24 V	Rated operational current	$I_e$	A	10	25	50	-
		Voltage per contact connected in series		Number	1	1	1	-
	48 V	Rated operational current	$I_e$	A	10	25	50	-
		Contacts		Number	2	2	2	-
	60 V	Rated operational current	$I_e$	A	10	25	50	-
		Contacts		Number	3	3	3	-
	120 V	Rated operational current	$I_e$	A	5	12	25	-
		Contacts		Number	3	3	3	-
	240 V	Rated operational current	$I_e$	A	5	5	20	-
		Contacts		Number	5	5	6	-
	DC-13, control switch L/R = 50 ms	Rated operational current	$I_e$	A	10	20	25	-
		Voltage per contact connected in series		Number	32	32	24	-
Control circuit reliability at 24 V d.c., 10 mA			Fault probability	$H_f$	< 10 <sup>-5</sup> , < 1 failure for 100,000 switching operations			

## T0, T3 and T5B Cam switch-disconnectors- Approvals for North America

				T0	T3	T5B	
<b>Rating data for approved types UL File No E36332</b>							
<b>Contacts</b>							
Rated operational voltage	$U_e$			600	600	600	
Rated uninterrupted current	$I_u$			16	25	65	
Rated current		A		16	25	65	
Pilot duty				A 600 P 600	A 600		
<b>Switching capacity</b>							
AC-3, max, rated power, 40-60 Hz AC motors							
3-phase	200 V a.c.	HP		3	5	15	
	230 V a.c.	HP		3	7½	15	
	460 V a.c.	HP		10	15	40	
	575 V a.c.	HP		10	15	50	
	Single-phase	115 V a.c.	HP		1	1½	3
		200 V a.c.	HP		2	3	7½
230 V a.c.		HP		2	3	10	
Short-circuit rating							
Standard	600 V a.c.	kA		5	5	5	
	With back-up fuse		A	50	80	Class J	
	With circuit-breakers		Part No	NZMH6	NZMH6	-	
	Current setting		A	50	125	-	
Disconnect in motor circuits	600 V a.c.	kA		10	10	-	
	With back-up fuse		Class	20 A/J	40 A/J	-	
<b>Terminal capacity</b>							
Cu cable	Min	AWG		18	14	12	
	Max	MCM		14	10	4	
Tightening torque	Max	in-lb		8.8	17.6	35.3	

**Notes:** Do not use AW extension terminals where UL/CSA approval is required.

	UL approved protection types		
	UL/NEMA 1	UL/NEMA 3R	UL/NEMA 12
T0-./E; /Z;/SVB	•	•	-
T3-./E; /Z;/SVB	•	•	-
T5B-./E; /Z;/SVB	•	•	•

**Notes:** Protection types as defined in NEC (NFPA 70), UL, CSA, NEMA

## T6 and T8 Cam switch-disconnectors

				T6-3-8212/E/HI12	T6-160-...	T8-...
<b>General</b>						
Standards			IEC/EN 60947, VDE 0660, IEC/EN 60204, CSA, UL switch-disconnector to IEC/EN 60947-3 Load break switch according to IEC/EN60947-3			
Lifespan mechanical	Operations	x 10 <sup>6</sup>	0.1	0.1	0.1	
Maximum operating frequency	Operations/h		50	50	50	
Climatic proofing			Damp heat, constant to IEC 60068-2-78; Damp heat, cyclic to IEC 60068-2-30			
Ambient temperature (for derating information contact buletechnical@eaton.com)	Open	°C	-25 -50	-25 -50	-25 -50	
	Enclosed	°C	-25 -40	-25 -40	-25 -40	
Mounting position			Any	Any	Any	
Mechanical shock resistance to IEC 60068-2-27		Half-sinusoidal shock to 20 ms	g	>15	>15	
<b>Contacts</b>						
Rated operational voltage		$U_e$	V A C	690	690	690
Rated impulse withstand voltage		$U_{imp}$	V A C	6000	6000	6000
Overvoltage category/pollution degree				III/3	III/3	III/3
Rated uninterrupted current	Open	$I_u$	A	200	160	315
Load rating with intermittent operation, class 12	AB 60% DF		x $I_e$	2	2	2
	AB 40% DF		x $I_e$	1.6	1.6	1.6
	AB 25% DF		x $I_e$	1.3	1.3	1.3
Rated conditional short-circuit current	Load side	$I_q$	kA	5	30	5
	Supply side	$I_q$	kA	-	-	-
Short-circuit rating		Fuse	A gG/gL	20	35	80
Rated short-time withstand current (1s current)		$I_{cw}$	A <sub>rms</sub>	320	650	1300
Safe isolation according to EN 61140						
Between the contacts			VAC	440	440	440
Switching angle			°	90 60	90 60	90 60
Contact units			Number	Max. 3	Max. 3	Max. 3
Contacts with double-break				Max. 6	Max. 6	Max. 6
Current heat loss per contact at $I_e$			W	11	11	11
<b>Terminal</b>						
Solid or stranded			mm <sup>2</sup>	1 x 70 2 x 25	1 x 95 2 x 25	150
Flexible with ferrule to DIN 46228			mm <sup>2</sup>	1 x 50 2 x 16	1 x 50 2 x 16	120
Flat terminals for rails			mm <sup>2</sup>			1 x (25 x 5) 2 x (20 x-3)
Terminal screw				M6	M5, hexagon screw	M12
Tightening torque			Nm	5.6	14	25



## T6 and T8 Cam switch-disconnectors

				T6-3-8212/E/HI12	T6-160-...	T8-...	
<b>Switching capacity</b>							
AC Voltage							
Rated making capacity $\cos \varphi = 0.35$			A	1600	1600	2390	
Rated breaking capacity, motor load switch $\cos \varphi = 0.35$	230 V		A	1280	1280	1910	
	400 V		A	900	900	1800	
	500 V		A	880	880	1200	
	690 V		A	340	340	420	
Rated operational current, load-break switch AC-21A	440 V	$I_e$	A	125	160	315	
Motor rating Motor load switch AC-3	230 V	P	kW	22	22	22	
	230 V star-delta	P	kW	22	22	37	
	400/415 V	P	kW	37	45	55	
	400 V star-delta	P	kW	37	45	55	
	500 V	P	kW	37	37	37	
	500 V star-delta	P	kW	37	37	37	
	690 V	P	kW	22	22	37	
	690 V star-delta	P	kW	22	22	37	
Motor rating Motor load switch AC-23A	230 V	P	kW	37	37	75	
	400/415 V	P	kW	45	55	132	
	500 V	P	kW	55	75	132	
	690 V	P	kW	30	30	37	
Motor rating Motor load switch AC-15	230 V	P	kW	-	-	-	
	400/415 V	P	kW	-	-	-	
	500 V	P	kW	-	-	-	
DC Voltage							
DC-1, load switch L/R = 1 ms	Rated operational current	$I_e$	A	125	125	315	
	Voltage per contact connected in series		V	42	42	42	
DC-23A, motor load switch L/R = 15 ms	24 V	Rated operational current	$I_e$	A	125	125	250
		Voltage per contact connected in series	Number	1	1	1	
	48 V	Rated operational current	$I_e$	A	125	125	250
		Contacts	Number	2	2	2	
	60 V	Rated operational current	$I_e$	A	125	125	125
		Contacts	Number	3	3	3	
120 V	Rated operational current	$I_e$	A	50	50	50	
	Contacts	Number	3	3	3		
DC-13, control switch L/R = 50 ms	Rated operational current	$I_e$	A	125	125	250	
	Voltage per contact connected in series		Number	24	24		
Control circuit reliability at 24 V d.c., 10 mA	Fault probability		$H_f$	< 10 <sup>-5</sup> , < 1 failure for 100,000 switching operations			
<b>Auxiliary contact</b>							
Standards				Control circuit isolator to IEC/EN 60947-5 f			
Rated insulation voltage		$U_i$	V a.c.	500	500	-	
Rated uninterrupted current		$I_u$	A	10	10	-	
Rated operational current	AC-15 at 230 V			6		-	
	400 V/415 V			4		-	
Short-circuit rating	Max fuse	A	gG/gL	10		-	
Terminal capacity	Solid		mm <sup>2</sup>	0.75-2.5	0.75-2.5	-	
	Flexible with ferrule to DIN 46228		mm <sup>2</sup>	0.5-1.5	0.5-1.5	-	
Tightening torque			Nm	0.35	0.35	-	
Control circuit reliability at 24 V d.c., 10 mA	Fault probability		HF	< 10 <sup>-5</sup> , < 1 failure for 100,000 switching operations			

# Dimensions

## TM Flush mounting /E - mm

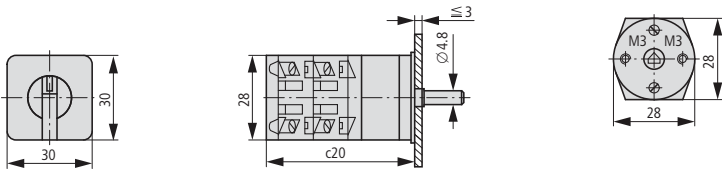

### Drilling dimensions

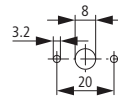

## TM Flush mounting TM.../E/SVB-(SW) - mm

Control circuit isolators for 2 padlocks  $\varnothing$  4 mm or 1 padlock  $\varnothing$  6 mm

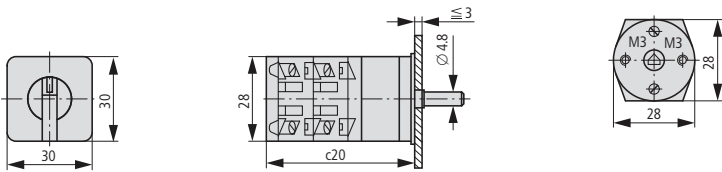

### Drilling dimensions

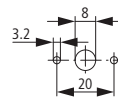

## TM Centre mounting /EZ - mm

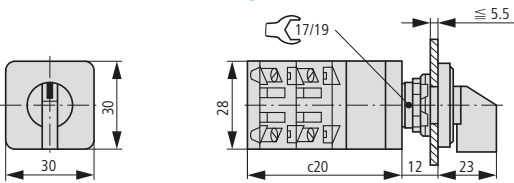

### Drilling dimensions<sup>1)</sup>

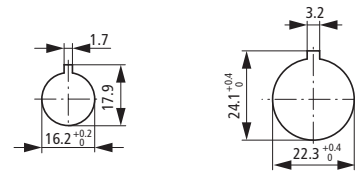

## TM Centre mounting with key operation TM-...+EZ/S - mm

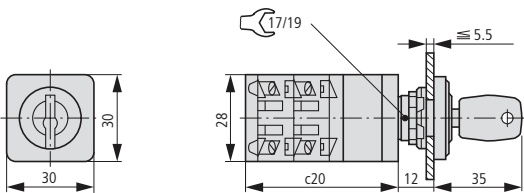

### Drilling dimensions<sup>1)</sup>

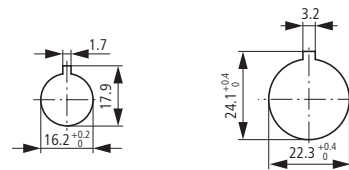

Part no.	c20	c21
TM-1	39	42
TM-2	51	54
TM-3	63	66
TM-4	75	
TM-5	87	
TM-6	99	
TM-7	111	
TM-8	123	

Depth of one contact unit: 12 mm

## TM Service distribution board mounting /IVS - mm

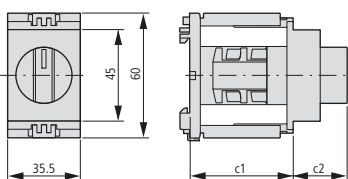

Part no.	c1	c2
TM-1	44	21
TM-2	46	26.5

Depth of one contact unit 12 mm

### TM-.../IVS/S

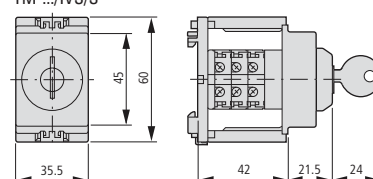

Drilling dimensions optionally: 16.2 mm = without reduction RMQ16; 22.3 mm = with reduction RMQ Titan

# Dimensions

## T0 and T3 Flush mounting /E (+H-T0) - mm

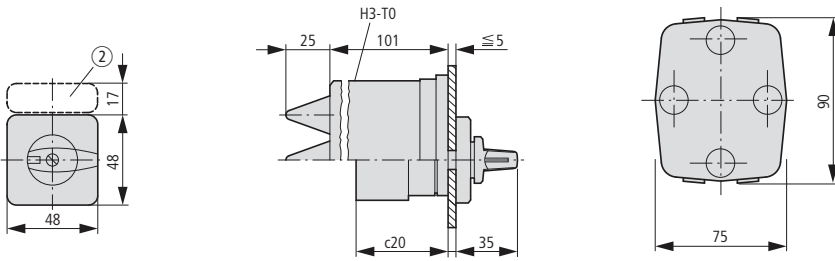

Drilling dimensions

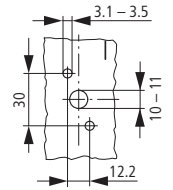

## T0 and T3 Centre mounting /EZ - mm

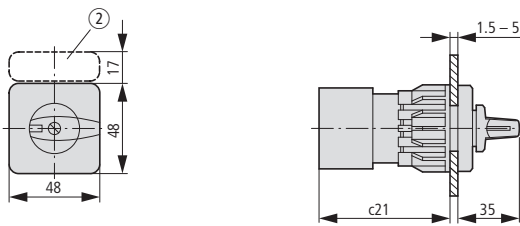

T0

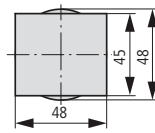

T3

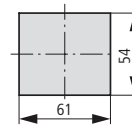

Drilling dimensions

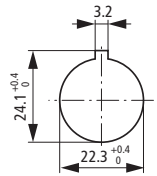

Part no.	c20	c21
T0-1...	41	61
T0-2...	50	70
T0-3...	60	80
T0-4...	69	89
T0-5...	79	99
T0-6...	88	108
T0-7...	98	118
T0-8...	107	127
T0-9...	117	137
T0-10...	126	146
T0-11...	136	156

Depth of one contact unit: 9.5 mm

Part no.	c20	c21
T3-1...	44	64
T3-2...	56	76
T3-3...	67	87
T3-4...	79	99
T3-5...	90	110
T3-6...	102	122
T3-7...	113	133
T3-8...	125	145
T3-9...	136	156
T3-10...	148	168
T3-11...	159	179

Depth of one contact unit: 11.5 mm

② Not included as standard

## T0 Service distribution board mounting /IVS - mm

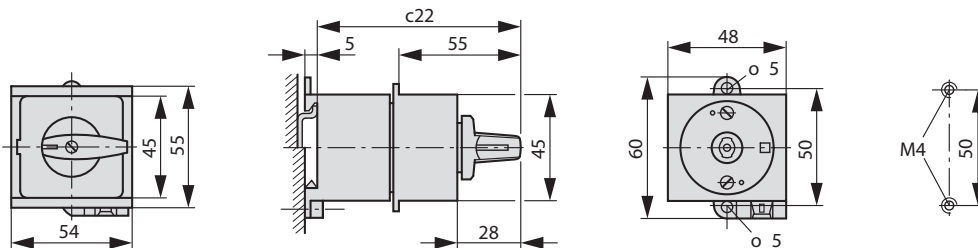

# Dimensions

## T0 and T3 Rear mounting /Z - mm

① Extension with

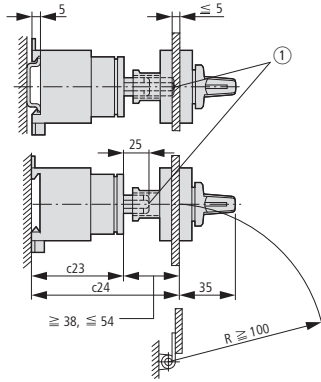
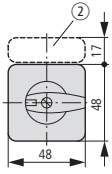

Drilling dimensions base

Drilling dimensions door

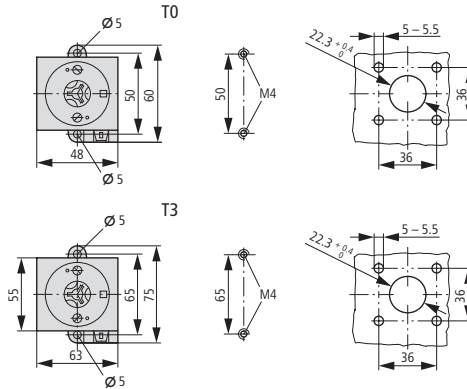

ZAV-T0 possible,  
≤ 4 x 25 = 100 mm

Part no.	c20	c21	c22	c23	c24 ≧/≦	c24 with ≦ 4 ZAV	c25	Part no.	c20	c21	c22	c23	c24 ≧/≦	c24 with ≦ 4 ZAV	c25
T0-1...	41	61	77	48	86 - 102	202	72	T3-1...	44	64	80	51	86 - 105	205	79
T0-2...	50	70	87	57	96 - 112	212	72	T3-2...	56	76	92	63	101 - 115	216	79
T0-3...	60	80	96	67	105 - 121	221	91	T3-3...	67	87	103	74	112 - 128	228	101
T0-4...	69	89	106	76	115 - 131	231	91	T3-4...	79	99	115	86	124 - 139	239	101
T0-5...	79	99	115	86	124 - 140	240	-	T3-5...	90	110	126	97	135 - 151	251	-
T0-6...	88	108	125	95	134 - 150	250	-	T3-6...	102	122	138	109	147 - 162	262	-
T0-7...	98	118	134	105	143 - 159	259	-	T3-7...	113	133	149	120	158 - 174	274	-
T0-8...	107	127	144	114	153 - 169	269	-	T3-8...	125	145	161	132	170 - 185	285	-
T0-9...	117	137	154	124	162 - 178	278	-	T3-9...	136	156	172	143	181 - 196	296	-
T0-10...	126	146	163	133	172 - 188	288	-	T3-10...	148	168	184	155	193 - 208	308	-
T0-11...	136	156	173	143	181 - 197	297	-	T3-11...	159	179	195	166	204 - 219	319	-

Depth of one contact unit: 9.5 mm

Depth of one contact unit: 11.5 mm

② Not included as standard

## T0 and T3 Flush mounting Main switch /EA/SVB - mm

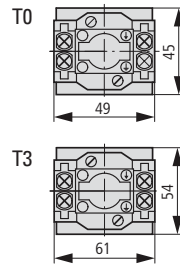
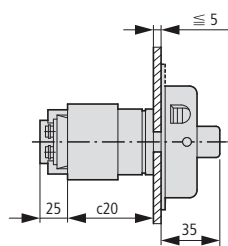
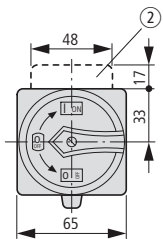

Drilling dimensions door

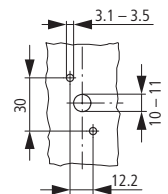

# Dimensions

## T0 and T3 Rear Main switch /V/SVB - mm

Rear mounting main switches  
T0.../V/SVB  
T3.../V/SVB

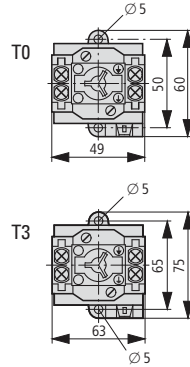
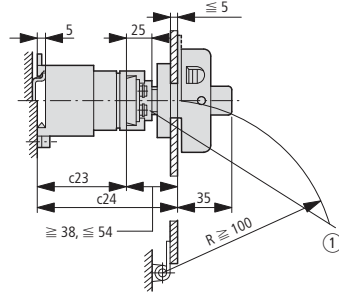
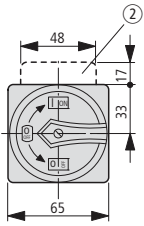

Drilling dimensions  
base



Drilling dimensions  
door

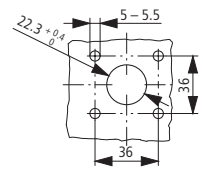

- ① Interlock extension possible with ZVV-T0 + ZAV-T0, F 4 x 25 = 100 mm
- ② Not included as standard

## T0 Surface mounting /I1 - mm

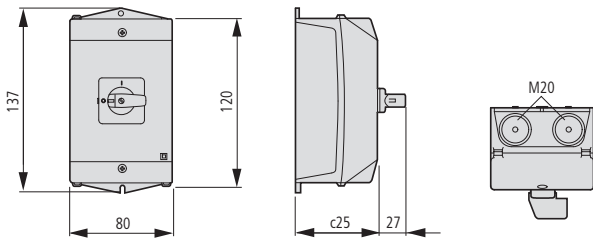

Drilling dimensions  
base

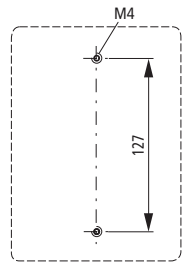

## T0 Surface mounting main switches /I1 padlock facility - mm

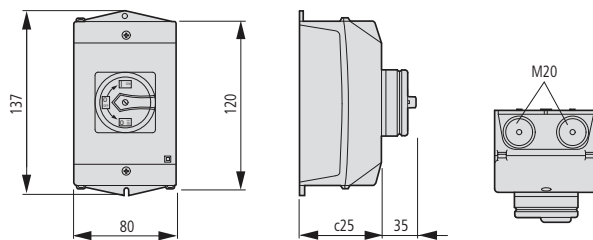

Drilling dimensions  
base

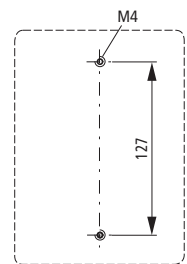

## T0 Surface mounting main switch /I2H/MBS/SVB with pre-assembled EMC screen - mm

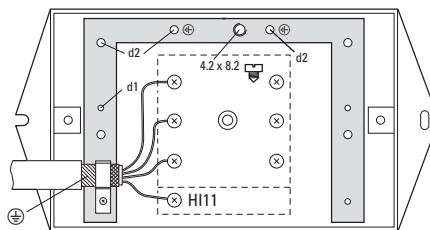
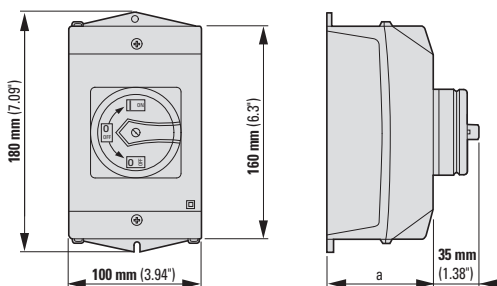

mm	in	mm	Ø	mm	in
7	0.28	2 x 4.2 x 8.2	d1	3.5	0.14
8	0.32	2 x 4.2 x 8.2	d1	3.5	0.14
10	0.39	2 x 4.2 x 8.2	d1	3.5	0.14
12	0.47	2 x 4.8 x 10.5	d2	4.1	0.16

a = 101 mm (3.98 inches)

# Dimensions

## T3 Surface mounting /I2 - mm

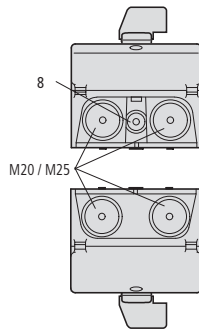
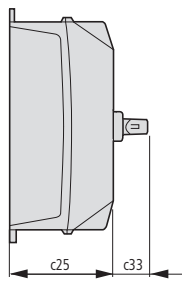
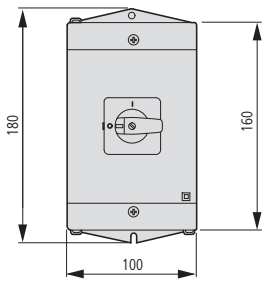

Drilling dimensions base

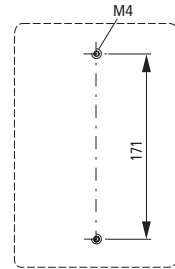

## T3.../I2/SVB Surface mounting main switch - mm

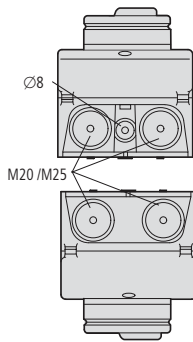
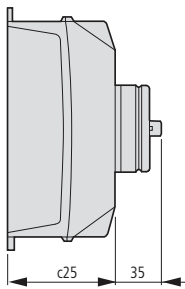
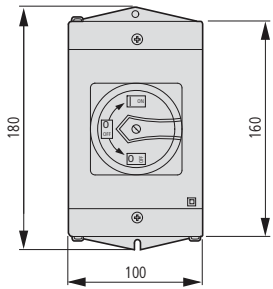

≤ 3 padlocks

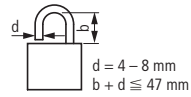

Drilling dimensions base

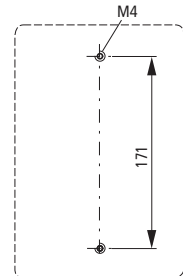

Part no.	c25
T0-1...	75
T0-2...	75
T0-3...	95
T0-4...	95

Part no.	c25	c33
T3-1...	80	27
T3-2...	80	27
T3-3...	100	35
T3-4...	100	35
T3-5...	145	35

## Key operated lock mechanism - mm

S-T0  
S-SOND...-T0

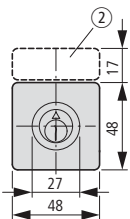

T0.../E(I1) + S-(SOND-)T0  
T3.../E(I2) + S-(SOND-)T0

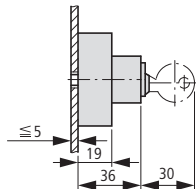

T0.../Z + S-(SOND-)T0  
T3.../Z + S-(SOND-)T0

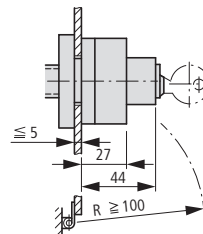

T0.../EZ = T0.../E + EZ-T0 + S-(SOND-)T0  
T3.../EZ = T3.../E + EZ-T0 + S-(SOND-)T0

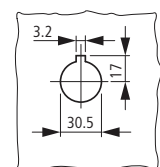
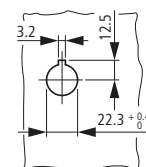
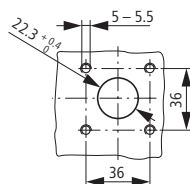
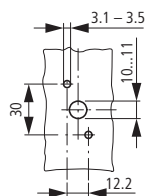
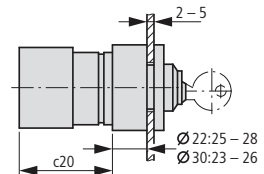

# Dimensions

## Cylinder lock - mm

SVA-T3

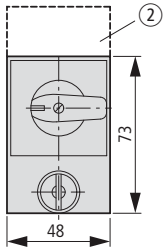

T0.../11/SVA  
T3.../12/SVA  
P1.../12/SVA

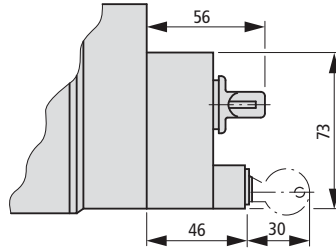

T0.../E/SVA...  
T3.../E/SVA...  
P1.../E/SVA

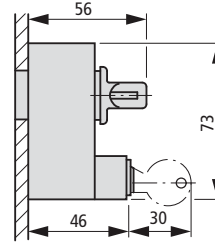

T0.../Z/SVA...  
T3.../Z/SVA...  
P1.../Z/SVA

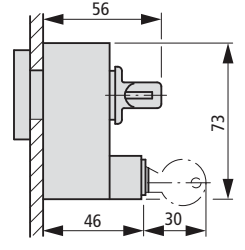

## Padlocking feature - mm

SVC-T3

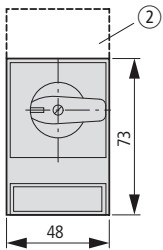

T0.../11/SVC  
T3.../12/SVC  
P1.../12/SVC

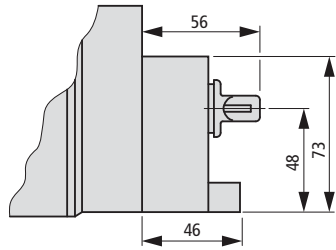

T0.../E/SVC...  
T3.../E/SVC...  
P1.../E/SVC

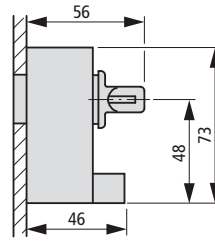

T0.../Z/SVC...  
T3.../Z/SVC...  
P1.../Z/SVC

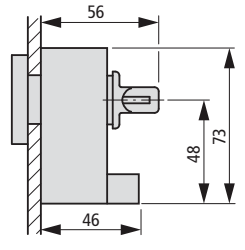

## Modules - mm

Switched neutral conductor N-P...  
Auxiliary contacts HI 11-P1/P3

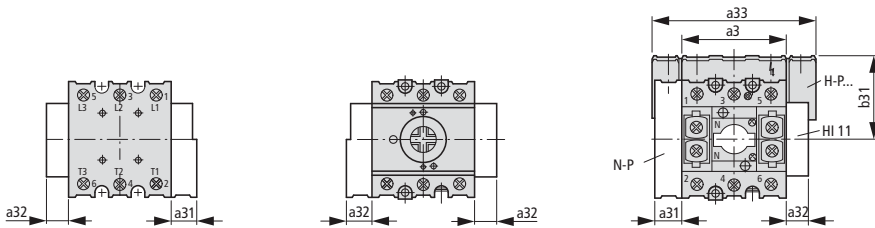

≤ 3 padlocks

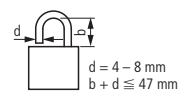

Part no.	a3	a31	a32	a33	b31
P1-...	49	15	15	83	49
P3-..	72	18	15	114	60

② Not included as standard

# Dimensions

## T5(B) Flush mounting /E - mm

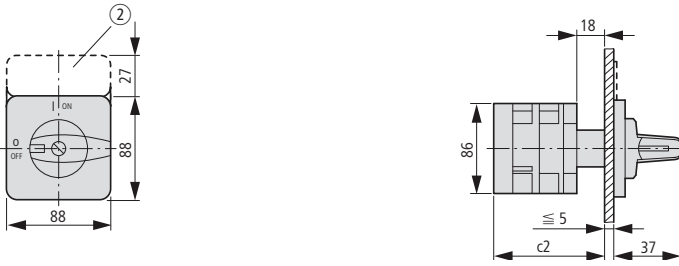

Drilling dimensions door

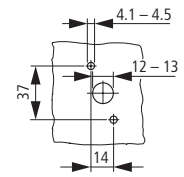

## T5(B) Flush mounting main switches /EA/SVB - mm

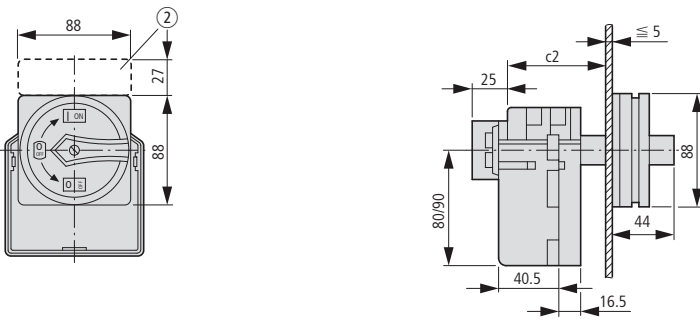

Drilling dimensions door

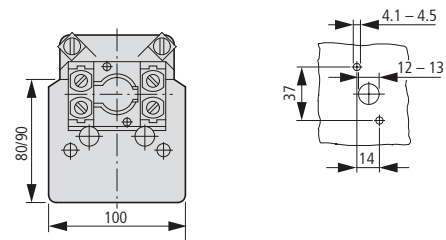

## T5(B) Rear mounting /Z - mm

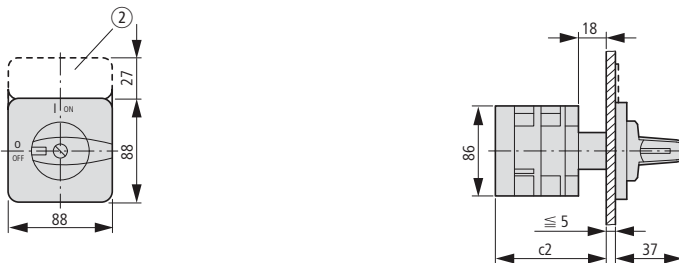

Drilling dimensions door

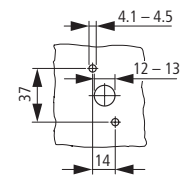



# Dimensions

## T5(B) Rear mounting main switch /V/SVB - mm

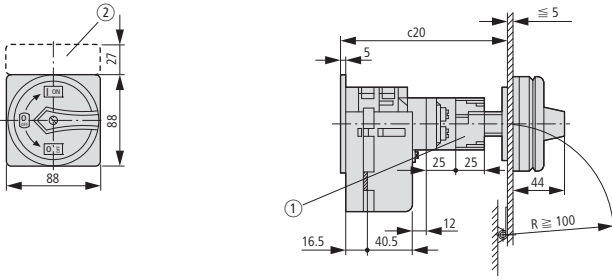

Part no.	c2	c20 ≥/≤	c20 with ≤ 4 ZAV	c21	c22
T5(B)-1...	54	92 – 107	207	90	125 (95)
T5(B)-2...	71	109 – 124	224	90	125 (95)
T5(B)-3...	87	125 – 140	240	123	160 (160)
T5(B)-4...	104	142 – 157	257	123	160 (160)
T5(B)-5...	120	158 – 173	273	–	–
T5(B)-6...	137	175 – 190	290	–	–
T5(B)-7...	153	191 – 206	306	–	–
T5(B)-8...	170	208 – 223	323	–	–
T5(B)-9...	186	224 – 239	339	–	–
T5(B)-10...	203	240 – 356	356	–	–

Depth of one contact unit: 16.5 mm

Drilling dimensions  
base

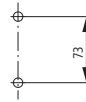

Drilling dimensions  
door

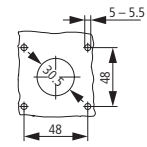

- ① Extension possible with ZVV-P3,  $\leq 4 \times 25 = 100$  mm
- ② Not included as standard

Cam switches T5B and T5 have identical designs, only their contacts are different

## T5B Surface mounting /I4 - mm

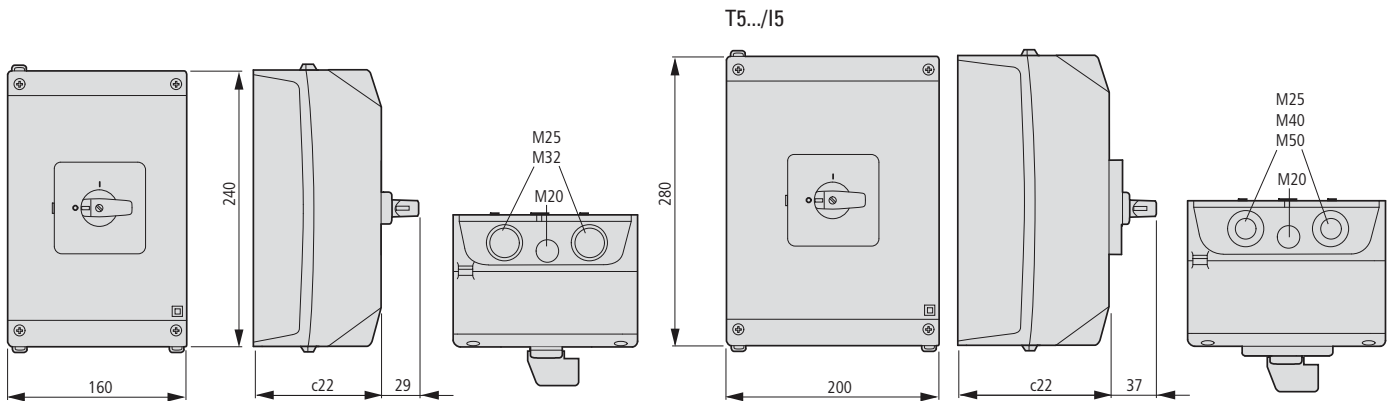

## T5B Surface mounting main switches /I4/SVB - mm

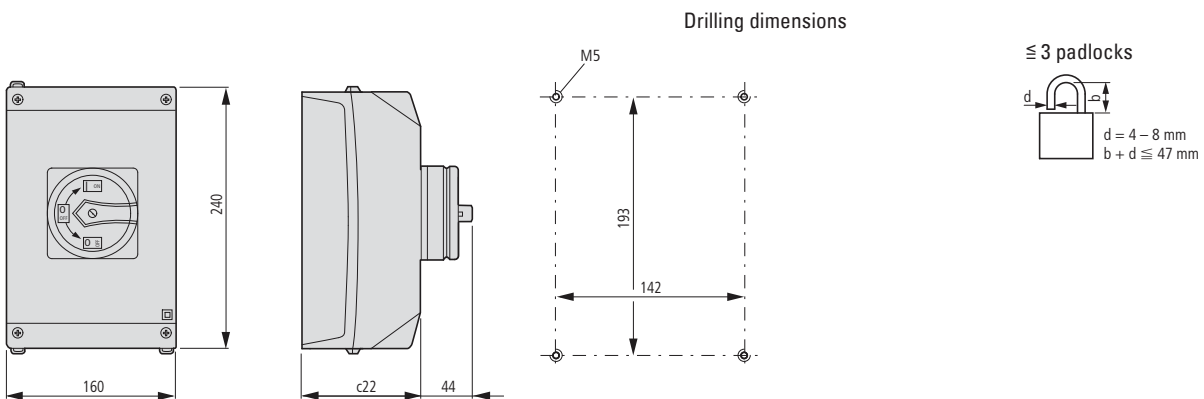

# Dimensions

## T5 Surface mounting main switches /I5/SVB - mm

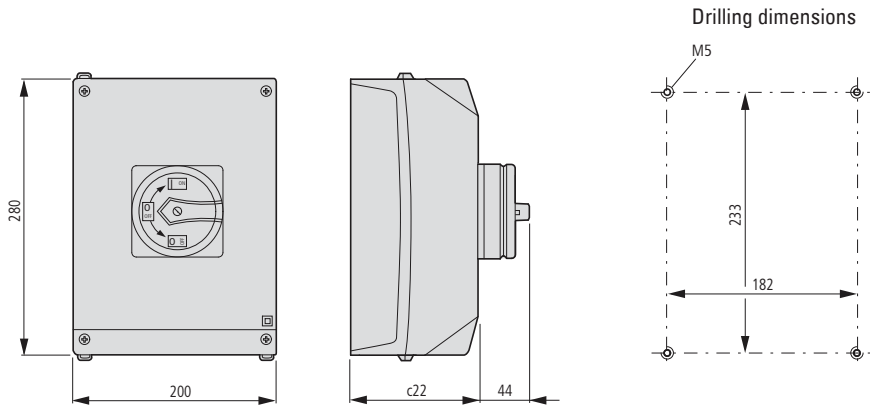

## AB-CI-K415 External fixing brackets -mm

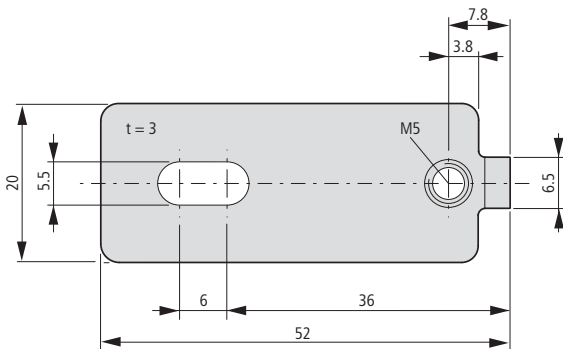

Part no.	c22
T5(B)-1...	125
T5(B)-2...	125
T5(B)-3...	160
T5(B)-4...	160

Depth of one contact unit: 16.5 mm

Cam switches T5B and T5 have identical designs, only their contacts are different

## T6-3-8212/E/HI12 and T8-3-8212/E/HI12 Flush mounting - mm

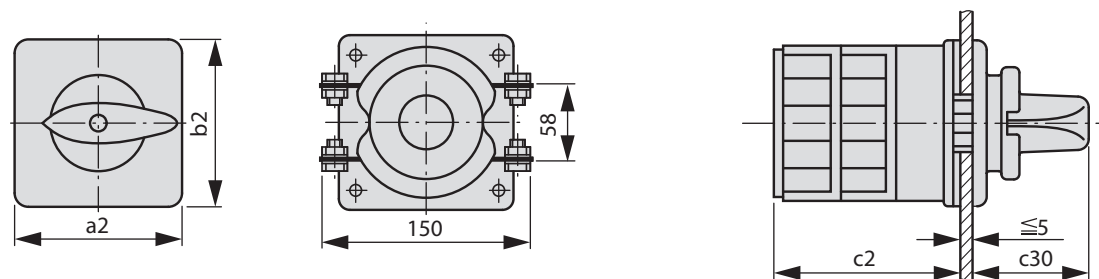



# Dimensions

## P Rear mounting /Z - mm

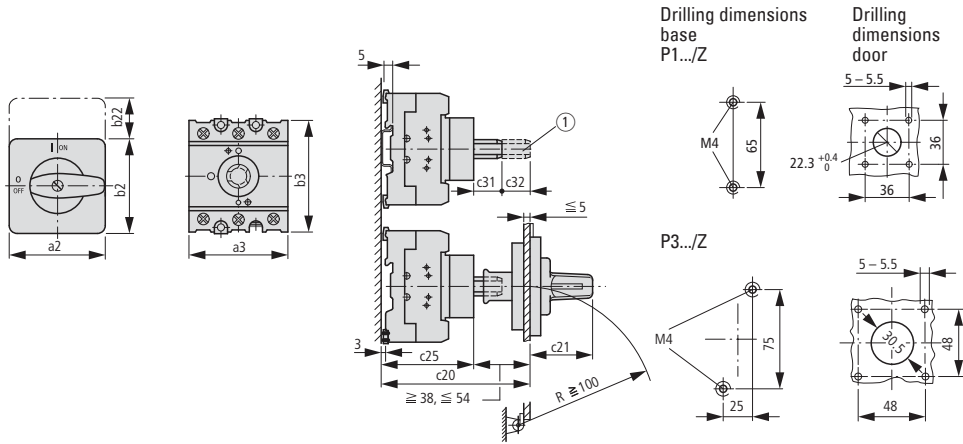

① Shaft extension with ZAV... possible  $\leq 4 \times 25 = 100$  mm

Part no.	a2	a3	a4	a21	a22	a23	a31	a32	a33	b2	b3	b21	b22	b23	b24	b31
P1	48	49	53.5	65	48	87	15	15	83	48	70	65	17	180	32	49
P3	87	72	71.5	87	87	125	18	15	114	87	83	87	27	175	-	60

Part no.	c2	c3	c20 $\cong/\cong$	c20 with $\cong 4$ ZAV/ZVV	c21	c22	c23	c24	c25	c27	c28	c31	c32	c33
P1	59	86	96 - 112	212	35	32	65	68	58	35	77	25	25	27
P3	59	82	103 - 118	218	37	41	63	81	65	44	90	25	25	29

## P Flush mounting main switch /EA/SVB - mm

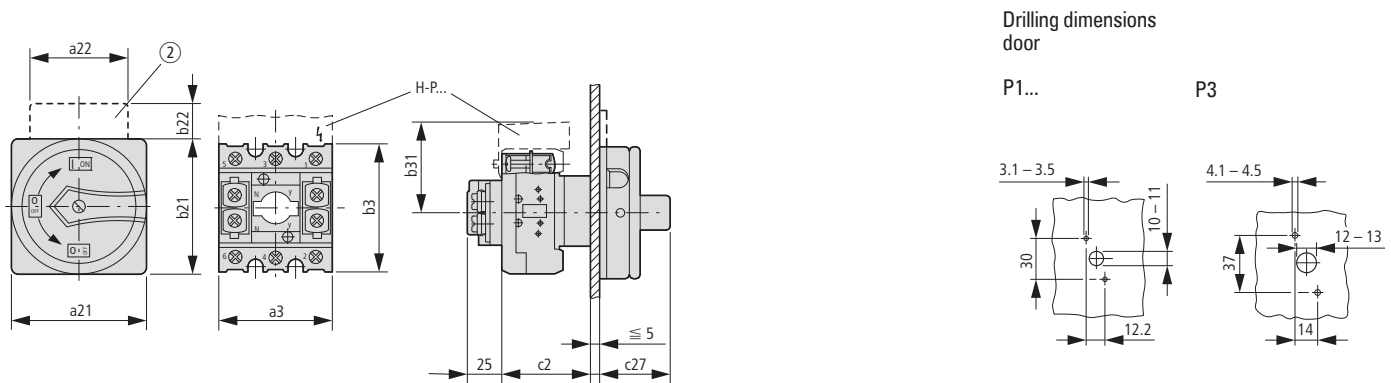

## P Rear mounting main switch /V/SVB - mm

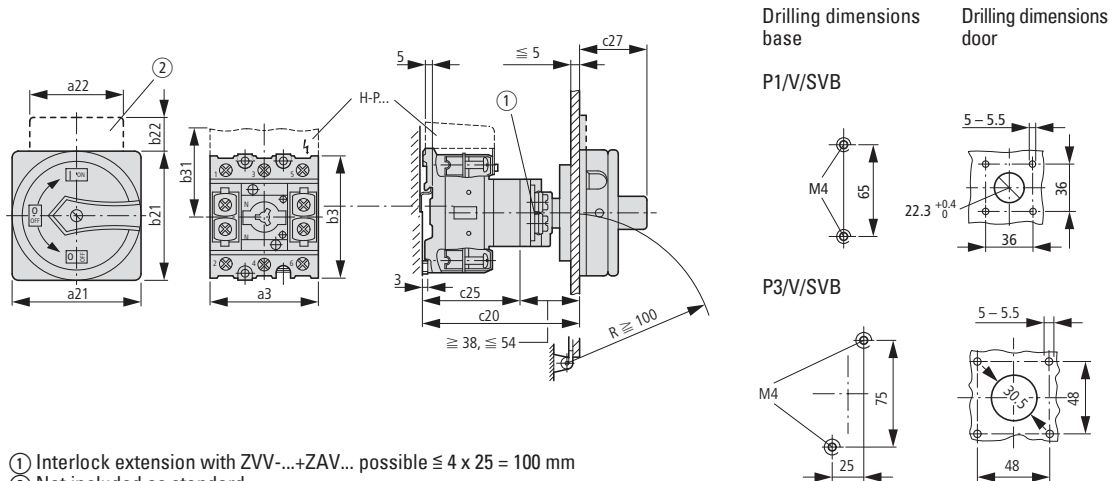

① Interlock extension with ZVV...+ZAV... possible  $\leq 4 \times 25 = 100$  mm  
 ② Not included as standard

# Dimensions

## P1 Surface mounting /I2 - mm

Surface mounting  
P1.../I2

Surface mounting main switches/safety switches  
P1.../I2/SVB / P1.../I2/SI

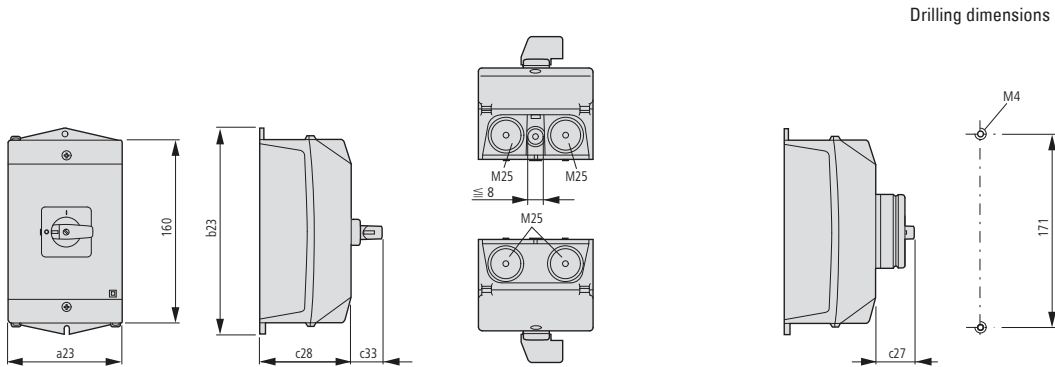

Part no.	a2	a3	a4	a21	a22	a23	a31	a32	a33	b2	b3	b21	b22	b23	b24	b31
P1.../I2	48	49	53.5	65	48	100	15	15	83	48	70	65	17	180	35.5	49

Part no.	c2	c3	c20 ≧/≦	c20 with ≧ 4 ZAV/ZVV	c21	c22	c23	c24	c25	c27	c28	c31	c32	c33
P1...	59	86	96 – 112	212	35	32	65	68	58	35	80	25	25	27

## P1 Surface mounting main switch /I2H/MBS/SVB with pre-assembled EMC screen - mm

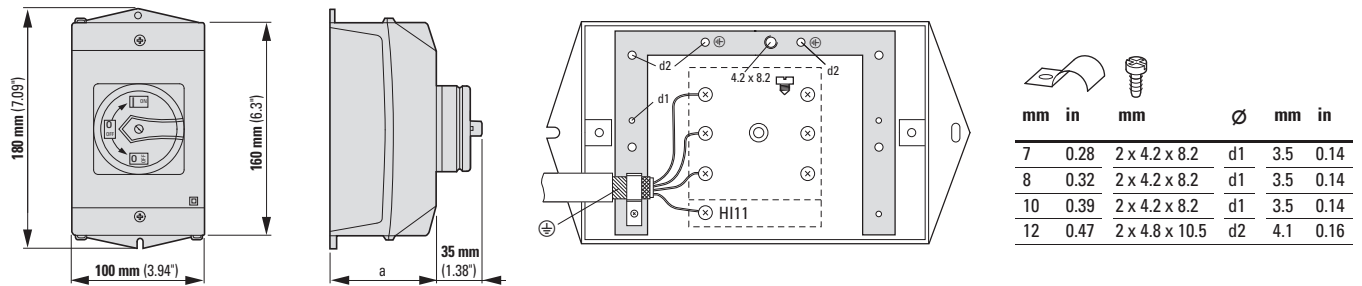

a = 101 mm (3.98")

## P3-63 Surface mounting /I4 - mm

Surface mounting  
P3-63/I4

Surface mounting main switches/safety switches  
P3-63/I4/SVB  
P3-63/I4/SI  
T5B..I4/SI

Drilling dimensions

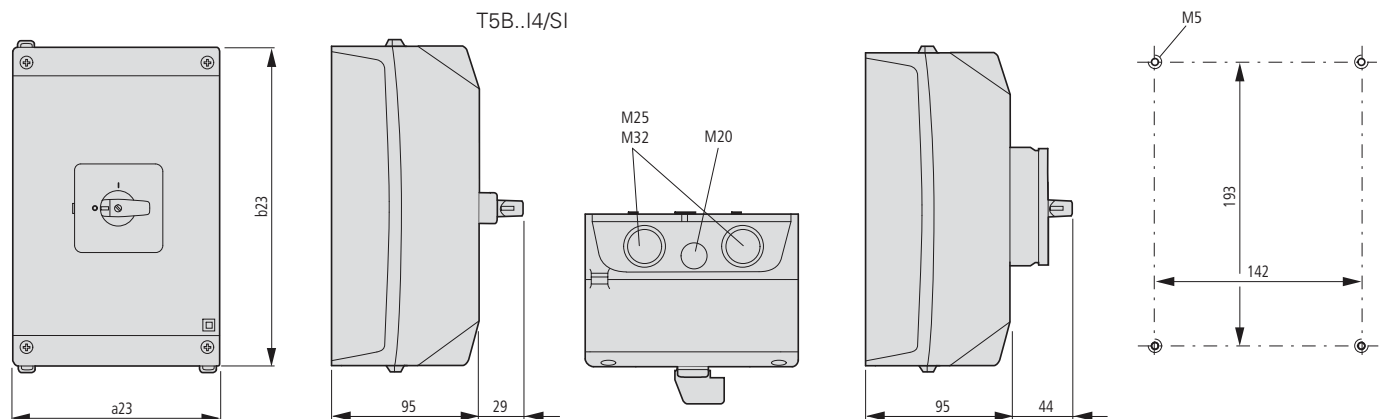

# Dimensions

## P3 Surface mounting main switch /I4/MBS/SVB with pre-assembled EMC screen - mm

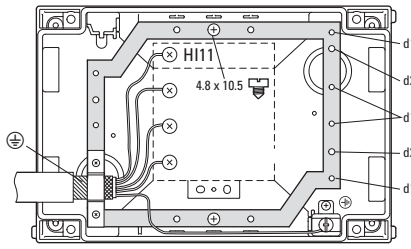
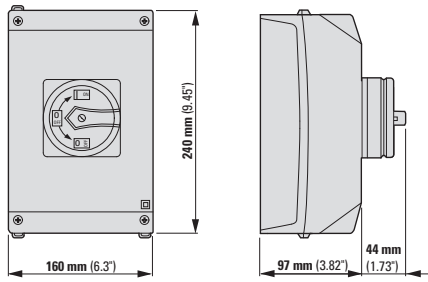

mm	in	mm	Ø	mm	in
12	0,47	2 x 4,8 x 10,5	d2	4,1	0,16
16	0,63	2 x 4,8 x 10,5	d2	4,1	0,16
20	0,79	2 x 4,2 x 8,2	d1	3,5	0,14

## P3-100 Surface mounting /I5 - mm

Surface mounting  
P3-100/I5

Surface mounting main switches/safety switches  
P3-100/I5/SVB  
P3-100/I5/SI  
T5-.../I5/SI

Drilling dimensions

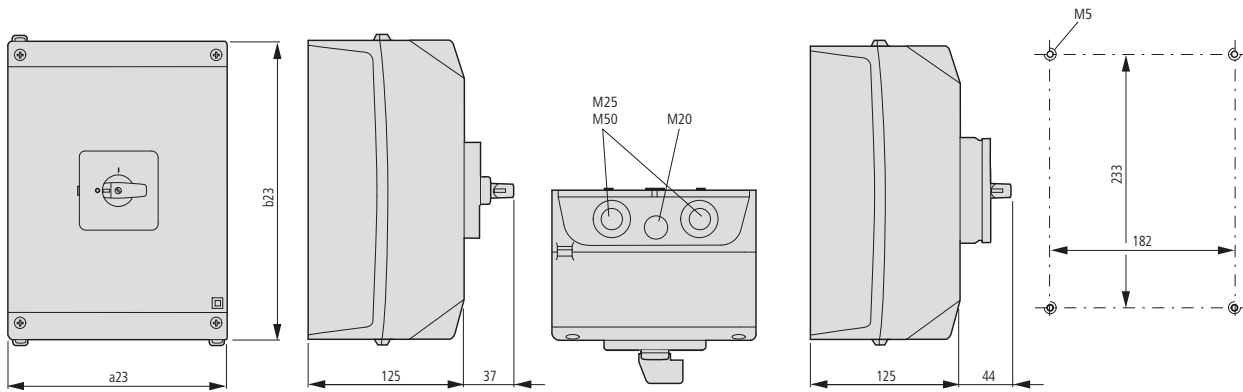

Part no.	a2	a3	a4	a21	a22	a23	a31	a32	a33	b2	b3	b21	b22	b23	b24	b31
P3-63/I4	87	72	71.5	87	87	160	18	15	114	87	83	87	27	240	35.5	60
P3-100/I5	87	72	71.5	87	87	200	18	15	114	87	83	87	27	280	35.5	60

Part no.	c2	c3	c20 ≅/≅	c20 with ≤ 4 ZAV/ZVV	c21	c22	c23	c24	c25	c27	c28	c31	c32	c33
P3-63	59	82	103 – 118	218	37	41	63	81	65	44	125	25	25	37
P3-100	59	82	103 – 118	218	37	41	63	81	65	44	125	25	25	37

# Dimensions

## CI-K Polycarbonate enclosures - Dimensions overview - mm

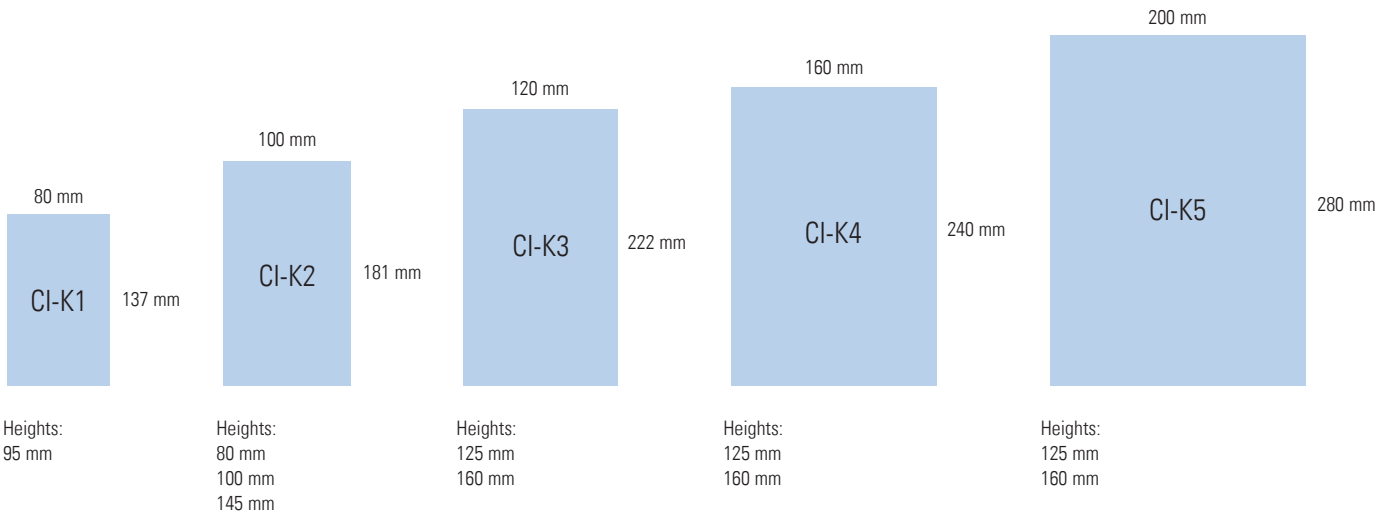

### CI-K1 - mm

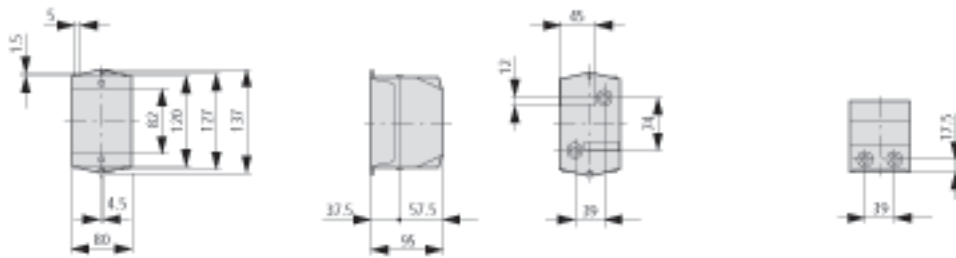

### CI-K2 - mm

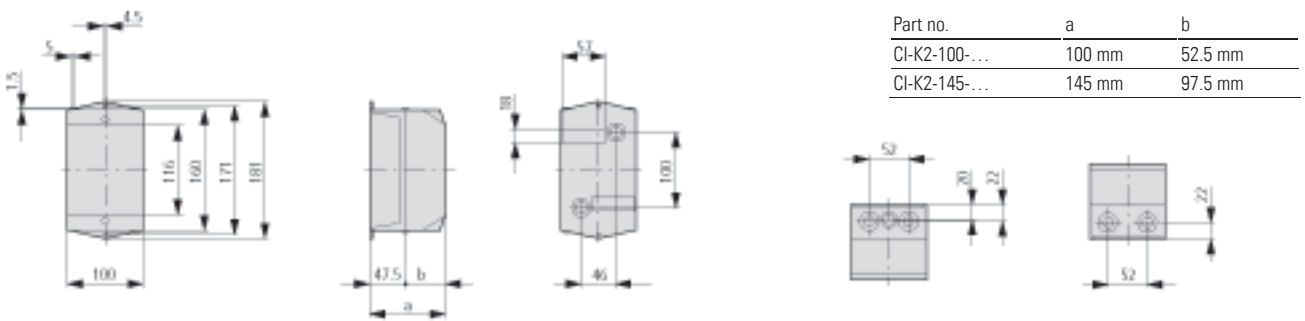

### CI-K3 - mm

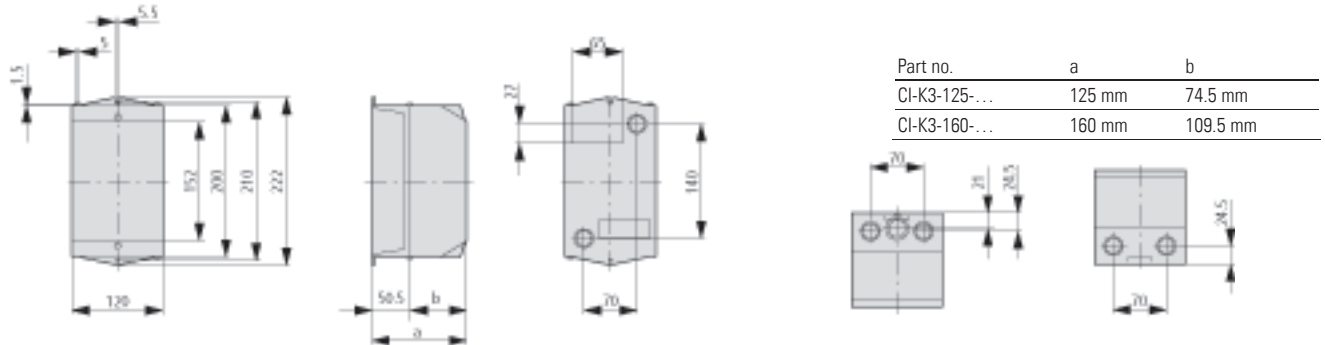

# Dimensions

## CI-K4 - mm

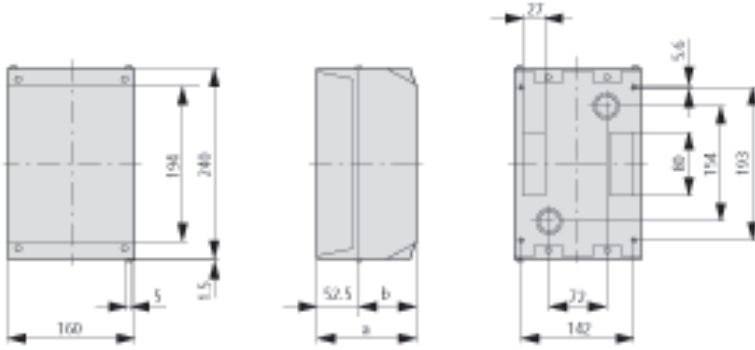

Part no.	a	b
CI-K4-125-...	125 mm	72.5 mm
CI-K4-160-...	160 mm	107.5 mm

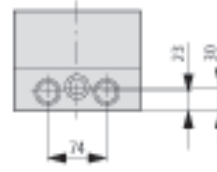

## CI-K5 - mm

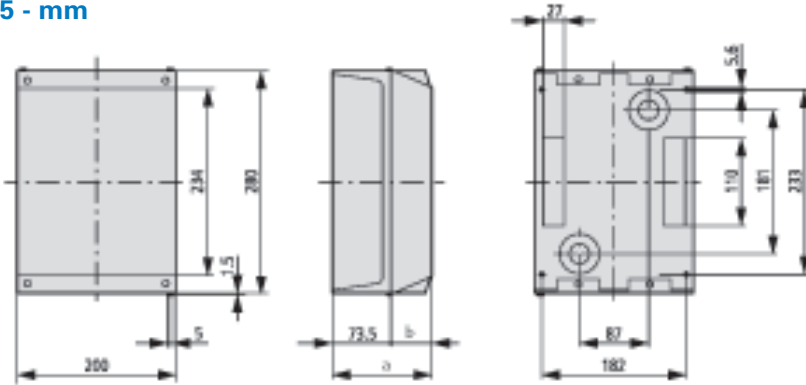

Part no.	a	b
CI-K5-125-...	125 mm	51.5 mm
CI-K5-160-...	160 mm	86.5 mm

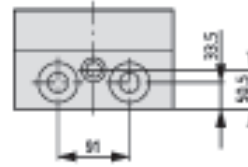



# Index - By article number

Article number	Part number	Page
000649	KNK-P3	92
000650	KNK-T0	92
000651	N-P1E	45, 159
000652	N-P1Z	91, 113, 152, 159
000687	T3-2-8400/EZ	60
000691	TM-1-15431/EZ	58
000692	TM-1-8220/EZ	53
000693	TM-1-8290/EZ	49
000694	T3-3-8401/EZ	60
000695	T3-3-8228/EZ	60
000698	TM-3-8261/EZ	63
000699	TM-2-8550/EZ	55
000700	TM-2-8231/EZ	66
000701	TM-2-8230/EZ	66
000721	T3-4-8410/EZ	61
000797	T3-5-15876/EZ	60
000893	T0-5-15876/E	36
000900	T0-5-15876/EZ	60
000902	T0-5-15876/IVS	106
000942	T0-5-15876/Z	85
000956	T3-3-8451/EZ	59
000959	T3-4-8440/EZ	59
001025	T3-2-8221/EZ	54
001069	T3-3-8222/EZ	54
002388	P1-25/E-RT	22
002513	T3-4-8294/E	29
002538	T3-3-8228/EZ	35
003072	T3-1-8210/EZ	52
003075	T3-2-8211/EZ	52
003079	T3-4-8213/EZ	52
003080	T3-3-8212/EZ	52
003191	T0-2-15435/E	33
003192	T0-2-15435/EZ	58
003195	T0-2-15435/IVS	104
003196	T0-2-15435/Z	83
003197	P1-32/E-RT	22
003198	FS908GE-T0	155
004506	T3-6-8370/EZ	54
004882	T3-1-8200/IVS/SVB-SW	73
004886	T3-4-8294/Z	81
004911	T3-3-8228/Z	85
005743	P3-63/E-RT	22
007189	P3-100/E-RT	22
007255	T3-1-8200/IVS/SVB	74
008267	T0-4-8344/EA/SVB	25
008268	T0-4-8344/EA/SVB-SW	24
008272	T0-4-8344/IVS/SVB-SW	73
008964	T3-4-8344/EA/SVB	25
008965	T3-4-8344/EA/SVB-SW	24
008967	T3-4-8344/IVS/SVB-SW	73
009046	T0-1-102/E-RT	22
009474	T0-1-8200/E-RT	22
009632	T3-1-8214/E	30
009657	T3-4-8410/E	38
009741	TM-5-8247/E	40
010366	T0-3-8401/Z	85
010371	T0-4-8294/E	29
010372	T0-2-8221/EZ	54
010378	T0-5-8270/Z	89
010380	T0-6-8370/Z	82
010381	T0-2-15452/Z	83
010382	T0-1-15322/E	21
010398	P3-63/EA/SVB/N	25
010402	P1-32/IVS/N	97
010405	T0-4-15682/E	23
010807	TM-3-8212/E	28
011082	T0-2-1/E-RT	22
012002	T3-3-15680/EA/SVB	27
012030	T3-4-8410/Z	87
012742	T0-1-8210/E	29
012747	T0-6-15866/EZ	60
012749	T0-3-8244/IVS	109
012750	T0-2-8231/E	42
012752	T0-1-15421/IVS	101
012753	T0-8-8372/Z	82
012755	T0-1-15322/EZ	50
012759	T0-3-8007/IVS	107
012771	P3-63/EA/SVB-SW/N	24
012772	P1-32/EA/SVB-SW/H11	26
012778	T0-4-15682/EZ	51
013140	P1-25/IVS-RT	99
013180	TM-4-8213/E	28
013971	T0-4-8251/E	42
013972	T0-3-8251/EZ	65
013974	T0-3-8251/IVS	110
013976	T0-3-8251/Z	89
014000	T0-4-8344/E	18
014002	T0-4-8344/EZ	49
014006	T0-4-8344/IVS	97
014007	T0-4-8344/IVS/SVB	74
014009	T0-4-8344/Z	70
014374	T3-1-102/EA/SVB	25
014375	T3-3-15680/EA/SVB-SW	26
014377	T3-2-15683/E	23
014933	T0-1-102/EZ/S	20
014971	T0-1-102/Z/S	71
015073	TM-1-8291/EZ	49
015096	TM-2-8292/EZ	49
015112	T0-3-8228/E	35
015118	T0-3-8222/EZ	54, 65
015122	T0-3-8244/Z	88
015123	T0-2-8231/EZ	65
015124	T0-6-8271/E	42
015125	T0-1-15421/Z	81
015127	T0-3-15453/E	33
015130	T0-2-8177/E	20
015132	T0-3-8007/Z	86
015137	TM-1-8210/EZ	53
015144	P3-63/IVS/VB/N	74

Article number	Part number	Page
015145	P1-32/IVS/VB/H11	76
015147	T0-1-102/IVS	97
015148	P1-32/Z/N	70
015166	TM-2-8211/EZ	53
015197	TM-2-8221/EZ	53
015226	TM-1-8240/EZ	63
015256	TM-2-8241/EZ	63
015506	TM-3-8242/EZ	63
015537	TM-3-8243/EZ	63
015554	TM-3-8401/E	35
015565	TM-5-8247/EZ	63
015571	T0-3-15683/EA/SVB	27
015592	TM-3-8232/EZ	66
015600	T0-3-15683/EA/SVB-SW	26
015630	TM-3-8233/EZ	66
015634	T0-3-15683/IVS/VB	76
015661	TM-5-8237/EZ	66
015664	T0-3-15683/IVS/SVB-SW	70
000902	TM-1-8175/EZ	50
016318	T3-1-102/E-RT	22
016619	T0-2-15683/E	23
016658	T0-2-15683/EZ	51
016722	T0-3-15683/IVS	100
016747	T3-1-102/EA/SVB-SW	24
016748	T3-3-15680/IVS/VB	76
016751	T3-2-8215/E	30
016776	T3-5-15876/E	36
016786	TM-1-8178/EZ	50
016878	TM-2-15432/EZ	58
016925	TM-1-8220F88/EZ	58
017025	T3-1-8200/E-RT	22
017253	H-P14	161
017497	T0-6-8271/EZ	65
017500	T0-3-15453/EZ	58
017501	T0-1-15322/IVS	90
017503	T0-2-8177/EZ	58
017517	P3-63/IVS/SVB-SW/N	73
017518	P1-32/IVS/SVB-SW/H11	75
017524	T0-4-15682/IVS	100
017926	TM-2-8219/E	28
018053	T0-1-15434/EZ	58
019120	T3-1-102/IVS/VB	75
019121	T3-3-15680/IVS/SVB-SW	74
019149	T3-5-15876/Z	85
019626	H-P14	161
019662	T0-1-8210/Z	81
019663	T0-1-8214/E	30
019664	T0-4-8223/EZ	54
019669	T0-2-8231/IVS	110
019871	T0-2-15422/E	33
019872	T0-1-15431/E	29
019875	T0-1-15511/E	27
019878	T0-3-15924/E	37
019890	P3-100/EA/SVB/N	25
019891	P3-63/EA/SVB/H11	27
019892	T0-4-15682/EA/SVB	27
019894	P3-63/E/N	18
019924	ZFS60-T0	156
019925	UV-T0	161
020299	TM-3-8299/E	28
020300	TM-2-8550/E	32
020593	T3-4-8344/E	18
020595	T3-4-8344/EZ	49
020598	T3-4-8344/IVS/SVB	74
020600	T3-4-8344/Z	70
021493	T3-1-102/IVS/SVB-SW	73
021999	H-P3	161
022234	T0-2-8211/E	29
022236	T0-2-8215/E	30
022242	T0-2-8231/Z	89
022243	T0-6-8271/IVS	110
022244	T0-2-15422/EZ	52
022245	T0-1-15431/EZ	58
022246	T0-3-15453/IVS	104
022248	T0-1-15511/EZ	50
022249	T0-2-8177/IVS	98
022251	T0-3-15924/EZ	62
022263	P3-100/EA/SVB-SW/N	24
022264	P3-63/EA/SVB-SW/H11	26
022265	T0-4-15682/EA/SVB-SW	26
022267	P3-63/IVS/N	97
022270	T0-4-15682/Z	72
022297	ZFS60-P3	156
022298	ZVV-T0	92
022330	T0-1-102/IVS/SVB-SW	73
022632	P1-32/IVS-RT	99
023869	T3-4-15682/E	23
023870	T3-3-8216/E	30
024604	T0-4-8410/E	38
024609	T0-3-8216/E	30
024610	T0-5-8369/EZ	59
024616	T0-6-8271/Z	84
024619	T0-3-15453/Z	83
024620	T0-2-15323/E	21
024622	T0-2-8177/Z	71
024636	P3-100/IVS/VB/N	74
024637	P3-63/IVS/VB/H11	76
024638	T0-4-15682/IVS/VB	76
024639	T0-2-1/E	18
024670	ZFSX-T0	156
024671	ZVV-P3	92
025045	TM-1-15431/E	33
025046	TM-4-8552/E	32
026861	P3-63/E	18
026885	T0-3-8451/IVS	105
026888	T0-3-8232/E	42
026890	T0-2-15422/IVS	101
026991	T0-1-15431/IVS	104
026993	T0-2-15323/EZ	50

Article number	Part number	Page
026994	T0-1-15511/IVS	98
026997	T0-3-15924/IVS	107
027009	P3-100/IVS/SVB-SW/N	73
027010	P3-63/IVS/SVB-SW/H11	75
027011	T0-4-15682/IVS/SVB-SW	75
027012	T0-2-1/EZ	49
027013	P3-63/Z/N	70
027043	ZFSX-P3	156
027044	ZAV-T0	92
027076	T0-1-8240/IVS	109
027418	TM-2-15432/E	33
028641	T3-3-8451/E	34
029353	T0-3-8212/E	29
029354	T0-2-8211/Z	81
029356	T0-6-8370/EZ	54
029358	T0-4-8440/IVS	105
029361	T0-3-8232/EZ	65
029363	T0-2-15422/Z	81
029364	T0-1-15431/Z	83
029365	T0-3-15391/E	44
029367	T0-1-15511/Z	71
029368	T0-4-15602/E	32
029370	T0-3-15924/Z	86
029382	T0-3-8342/EA/SVB	25
029383	P3-100/EA/SVB/H11	27
029387	T0-2-15679/E	23
029416	BS45X14-T0	156
029417	ZAV-P3	92
029452	T0-2-15920/EZ	107
029791	TM-3-15433/E	33
030170	ZFS61/62-T0	156
030988	T3-4-15682/Z	72
030992	T3-3-8401/E	35
031014	T3-3-8451/Z	84
031475	FS908GE-P3	155
031607	P3-63/EA/SVB	25
031726	T0-4-8213/E	29
031728	T0-1-8220/E	31, 42
031731	T0-4-8441/IVS	105
031738	T0-3-15391/EZ	56
031739	T0-2-15323/IVS	98
031741	T0-4-15602/EZ	55
031755	T0-3-8342/EA/SVB-SW	24
031756	P3-100/EA/SVB-SW/H11	26
031758	T0-2-1/IVS	97
031759	P3-100/E/N	18
031760	T0-2-15679/EZ	51
031789	BS4X24-P3	156
032164	TM-1-8214/E	30
034102	T0-8-8372/EZ	44
034105	T0-1-8240/E	51
034106	T0-3-8280/E	41
034107	T0-3-8232/IVS	110
034109	T0-3-15423/E	29
034110	T0-2-15432/E	33
034113	T0-2-15512/E	20
034116	T0-3-8048/E	37
034128	T0-3-8342/IVS/SVB	74
034129	P3-100/IVS/VB/H11	76
034132	P3-100/IVS/N	97
034537	TM-2-8215/E	30
035739	T3-3-8401/Z	85
035760	T3-4-8440/E	34
036473	T0-3-8212/Z	81
036477	T0-6-15866/IVS	106
036479	T0-3-8280/EZ	64
036480	T0-3-8232/Z	89
036482	T0-3-15423/EZ	52
036483	T0-2-15432/EZ	58
036484	T0-3-15391/IVS	112
036486	T0-2-15512/EZ	50
036487	T0-4-15602/IVS	103
036501	T0-3-8342/IVS/SVB-SW	73
036502	P3-100/IVS/SVB-SW/H11	75
036504	T0-2-1/Z	70
036506	T0-2-15679/IVS	100
038133	T3-4-8440/Z	84
038724	P1-25/E	18
038847	T0-3-8212/E	31
038849	T0-3-8451/E	34
038854	T0-1-15401/E	19
038861	T0-2-15920/E	37
038873	T0-2-1/EA/SVB	25
038875	T0-3-15680/EA/SVB	27
038878	P3-100/Z/N	70
038909	KNB-T0	154
039283	TM-2-8230/E	39
039298	TM-3-8232/E	39
040478	T3-3-15683/EA/SVB	27
041097	P1-25/EA/SVB	25
041099	P3-63/IVS	97
041222	T0-4-8440/E	34
041225	T0-3-8280/IVS	109
041226	T0-3-8233/E	42
041227	T0-1-15401/EZ	49
041228	T0-3-15423/IVS	101
041229	T0-2-15432/IVS	104
041234	T0-2-15920/EZ	62
041246	T0-2-1/EA/SVB-SW	24

# Index - By article number

Article number	Part number	Page	Article number	Part number	Page	Article number	Part number	Page
043595	T0-4-8441/E	34	050978	T0-2-1/2/SVA(A)	71	067759	TM-3-8261/E	40
043596	T0-3-8451/Z	84	050987	VR-T3	158	068949	T3-1-8200/EA/SVB-SW	24
043597	T0-1-8240/EZ	64	052344	T3-3-8342/Z	70	068956	T3-3-8212/E	29
043598	T0-3-8280/Z	88	052346	T3-3-8222/E	31	068957	T3-5-8369/Z	82
043599	T0-3-8233/EZ	65	052962	P1-25/IVS	97	069150	TM-5-8237/E	39
043601	T0-3-15423/Z	81	052999	SVB-P3	153	069304	T0-2-15907/EZ	58
043602	T0-2-15432/Z	83	053079	T0-2-8400/E	35	069697	T0-8-8372/IVS	102
043605	T0-2-15512/Z	71	053080	T0-4-8410/EZ	61	069700	T0-2-8242/EZ	64
043619	T0-2-1/V/SVB	74	053083	T0-2-8211/EZ	52	069701	T0-6-8282/IVS	109
043621	T0-3-15680/IV/SVB	76	053088	T0-4-8441/Z	84	069703	T0-2-15403/EZ	49
043624	T0-3-8342/E	18	053089	T0-2-8241/EZ	64	069705	T0-1-15434/IVS	104
043655	KNB-RT-T0	154	053092	T0-1-15402/E	19	069710	T0-2-15921/EZ	62
044029	TM-2-8231/E	39	053099	T0-2-15922/E	37	069724	P3-63/EA/SVB-SW/N/H11	26
044973	T0-2-1/E/SVC(S)-RT	22	053110	T0-1-8200/EA/SVB	25	069725	T0-1-8200/EZ	49
044974	P1-25/E/SVC(S)-RT	22	053111	P1-32/EA/SVB-SW	24	070131	TM-1-8290/E	18
044975	P1-32/E/SVC(S)-RT	22	053113	P1-25/V/SVB/N/H11	76	070132	TM-5-8281/E	40
044977	P1-32/E/SA(S)	21	053521	TM-3-8233/E	39	070194	P1-25/EA/SVB-SW/H11	26
045062	H1-T5	161	054716	T3-4-15682/EA/SVB	27	071326	T3-3-8342/EA/SVB	25
045063	H2-T5	161	054718	T3-1-8210/Z	29	071327	T3-1-8200/Z	70
045064	V/EA/SVB-SW/T5	154	054744	T3-6-15866/E	36	071329	T3-3-8212/Z	81
045065	V/EA/SVB/T5	154	055335	P1-25/V/SVB	74	072069	T0-4-8294/EZ	52
045224	T3-3-15683/IV/SVB	76	055452	T0-2-8400/EZ	60	072074	T0-6-8282/Z	88
045225	T3-3-8342/E	18	055459	T0-1-8220/IVS	102, 110	072078	T0-1-15434/Z	83
045227	T3-2-8221/E	31	055460	T0-6-15866/E	36	072079	T0-3-15394/E	44
045252	T3-4-8441/Z	84	055463	T0-5-8281/IVS	109	072082	T0-1-91/E	43
045458	EZ/S-A	67	055465	T0-1-15402/EZ	49	072097	P3-63/V/SVB/N/H11	76
045459	EZ/S-B	67	055466	T0-3-8216/Z	82	072504	TM-1-8291/E	18
045461	EZ/S-D	67	055467	T0-3-15433/IVS	104	072505	TM-3-8242/E	40
045462	EZ/S-E	67	055472	T0-2-15922/EZ	62	072567	P1-32/EA/SVB/H11	27
045463	EZ/S-F	67	055483	T0-1-8200/EA/SVB-SW	24	073695	T3-2-8400/E	35
045464	EZ/S-G	67	055484	P1-32/V/SVB-SW	73	073699	T3-3-8342/EA/SVB-SW	24
045465	EZ/S-H	67	055486	P1-25/V/SVB-SW/N/H11	75	073703	T3-6-8370/E	31
045466	EZ/S-J	67	055489	T0-3-8342/Z	70	074320	P3-100/EA/SVB	25
045468	EZ/S-N	67	055894	TM-6-8253/E	39	074437	T0-3-8228/Z	85
045471	EZ/S-R	67	057089	T3-4-15682/EA/SVB-SW	26	074440	T0-1-8210/IVS	101
045479	TM-1-8310/EZ	57	057091	T3-1-8210/Z	81	074446	T0-2-8242/IVS	109
045483	TM-2-8260/EZ	63	057092	T3-3-8222/Z	82	074449	T0-2-15403/IVS	97
045486	TM-2-8293/EZ	49	057117	T3-6-15866/Z	85	074450	T0-3-8221/Z	82
045487	TM-1-8311/EZ	57	057708	P1-25/Z	70	074452	T0-3-15394/EZ	56
045490	TM-3-15433/EZ	58	057829	T0-3-8212/EZ	52	074455	T0-1-91/EZ	67
045491	TM-3-8212/EZ	53	057832	T0-2-8221/IVS	102	074456	T0-2-15921/IVS	107
045493	TM-3-8222/EZ	53	057835	T0-2-8241/IVS	109	074470	P3-63/V/SVB-SW/N/H11	75
045496	TM-3-8280/EZ	63	057836	T0-5-8281/Z	88	074471	T0-1-8200/IVS	97
045845	P3-63/IVS-RT	99	057840	T0-3-15433/Z	83	074877	TM-2-8292/E	18
045847	TM-4-8213/EZ	53	057856	T0-1-8200/V/SVB	74	074878	TM-4-8262/E	40
045495	TM-3-8244/EZ	63	057857	P3-63/EA/SVB-SW	24	076072	T3-3-8342/IV/SVB	74
045967	T0-1-8214/IVS	101	057859	P1-32/EA/SVB/N/H11	27	076073	T3-1-102/E	18
045973	T0-1-15401/IVS	97	057892	SVB-T0	153	076075	T3-4-8213/E	29
045992	T0-2-1/V/SVB-SW	73	058267	TM-1-8240/E	40	076423	T0-2-15907/IVS	104
045994	T0-3-15680/IV/SVB-SW	75	059462	T3-4-15682/V/SVB	76	076813	T0-2-8211/IVS	101
045997	T0-3-8342/EZ	49	059465	T3-4-8223/E	31	076815	T0-1-8214/EZ	52
046028	KNB-RT-P3	154	060198	T0-2-8400/IVS	106	076819	T0-2-8242/Z	88
046119	TM-4-8223/EZ	53	060204	T0-5-8369/E	31	076820	T0-2-15403/Z	70
046120	TM-4-8262/EZ	63	060205	T0-3-8222/IVS	102, 110	076824	T0-1-15451/E	33
046123	TM-5-8252/EZ	66	060208	T0-1-8240/Z	88	076829	T0-2-15921/Z	86
046124	TM-5-8270/EZ	66	060211	T0-1-15402/IVS	97	076843	P3-100/EA/SVB/N/H11	27
046125	TM-5-8281/EZ	63	060218	T0-2-15922/IVS	107	076844	T0-1-8200/Z	70
046126	TM-5-8369/EZ	53	060229	T0-1-8200/V/SVB-SW	73	076845	P1-25/E/N	18
046127	TM-6-8253/E	66	060230	P3-63/V/SVB-SW	73	077250	TM-2-8293/E	18
046128	TM-6-8271/EZ	66	060232	P1-32/EA/SVB-SW/N/H11	26	077251	TM-6-8282/E	40
046402	TM-6-8271/E	39	060265	SVB-SW-T0	153	078445	T3-3-8342/IV/SVB-SW	73
046991	EZ/S-A-TM	67	060640	TM-2-8260/E	40	078446	T3-1-102/EZ	49
046992	EZ/S-B-TM	67	061813	H11-PIP3E	45, 160	078448	T3-4-8213/Z	81
046995	EZ/S-E-TM	67	061835	T3-4-15682/V/SVB-SW	75	078796	T0-2-15907/Z	83
046996	EZ/S-F-TM	67	061837	T3-2-8211/E	29	079065	P1-32/E	18
046997	EZ/S-G-TM	67	061838	T3-4-8223/Z	82	079186	T0-3-8212/IVS	101
047004	EZ/S-R-TM	67	062031	H11-PIP3Z	91, 113, 152, 160	079197	T0-1-15451/EZ	58
047422	ZFS77-P3	156	062432	N-PIE	45, 159	079198	T0-3-15394/IVS	112
047423	ZFS63-P3	156	062491	SVB-SW-P3	153	079201	T0-1-91/IVS	111
047424	ZFS63-T0	156	062571	T0-2-8400/Z	85	079216	P3-100/EA/SVB-SW/N/H11	26
047600	T3-2-8221/Z	82	062572	T0-3-8228/IVS	106	079218	P1-25/EZ/N	49
048218	P3-63/V/SVB	74	062575	T0-4-8213/EZ	52	079583	T0-1-102/IVS-RT	99
048289	UV-P3	161	062577	T0-6-8370/E	31	079623	TM-3-8256/E	18
048334	T0-3-8228/EZ	60	062578	T0-4-8223/IVS	102	079624	TM-3-8243/E	40
048337	T0-1-8210/EZ	52	062581	T0-2-8241/Z	88	080822	T3-8-8372/E	31
048339	T0-3-8222/E	31, 42	062582	T0-6-8282/E	41	081438	P1-32/EA/SVB	25
048340	T0-2-8215/IVS	101	062584	T0-1-15402/Z	70	081439	P3-100/IVS	97
048342	T0-4-8440/Z	84	062586	T0-1-15434/E	33	081559	T0-4-8213/IVS	101
048344	T0-5-8281/E	41	062591	T0-2-15922/Z	86	081561	T0-2-8215/EZ	52
048345	T0-3-8233/IVS	110	062603	P3-100/EA/SVB-SW	24	081565	T0-3-8243/E	41
048346	T0-1-15401/Z	70	062605	P1-32/V/SVB/N/H11	76	081568	T0-2-15404/E	19
048348	T0-3-15433/E	33	062638	V/EA/SVB-T0	154	081571	T0-3-15394/Z	90
048351	T0-3-15513/E	20	063013	TM-3-8280/E	40	081572	T0-1-15366/E	21
048353	T0-2-15920/Z	86	064208	T3-1-8200/E	18	081587	P1-25/EA/SVB/N	25
048365	P1-25/EA/SVB-SW	24	064210	T3-2-8211/Z	81	081588	T0-2-15670/EA/SVB	27
048367	P1-25/EA/SVB/N/H11	27	064805	N-P3Z	91, 113, 159	081589	P3-100/V/SVB/N/H11	76
048369	P1-32/EZ	49	064945	T0-4-8410/IVS	108	081622	EZ-T0	46
050591	P3-63/Z	70	064950	T0-8-8372/E	31	081956	T0-1-8200/IVS-RT	99
050712	T0-4-8223/E	31	064951	T0-5-8369/IVS	102	081996	TM-1-8220/E	28
050713	T0-3-8216/IVS	101	064955	T0-6-8282/EZ	64	081997	TM-3-8244/E	40
050716	T0-2-8241/E	41	064976	P3-100/V/SVB-SW	73	083192	T3-1-102/Z	82
050717	T0-5-8281/EZ	64	064978	P1-32/V/SVB-SW/N/H11	75	083195	T3-8-8372/Z	70
050718	T0-3-8233/Z	89	065011	V/EA/SVB-SW-T0	154	083929	T0-4-8410/Z	87
050720	T0-1-8214/Z	82	065386	TM-2-8241/E	40	083936	T0-3-8451/EZ	59
050721	T0-3-15433/EZ	58	065739	ZFS61/62/P3	156	083938	T0-3-8243/EZ	64
050724	T0-3-15513/EZ	50	065751	ZFS68-T0	156	083941	T0-2-15404/EZ	49
050738	P1-25/V/SVB-SW	73	065752	ZFS77-T0	156	083943	T0-1-15451/IVS	104
050740	P1-25/EA/SVB-SW/N/H11	26	066576	T3-1-8200/EA/SVB	25	083945	T0-1-15366/EZ	50
050743	T0-3-8342/IVS	97	066581	T3-1-8200/EZ	49	083960	P1-25/EA/SVB-SW/N	24
050965	P1-25/E/SVA(A)	20	066584	T3-5-8369/E	31	083961	T0-2-15670/EA/SVB-SW	26
050966	P1-25/E/SA(S)	21	066931	T0-2-15907/E	33	083962	P3-100/V/SVB-SW/N/H11	75
050967	P1-25/E/SVA(S)-RT	22	067201	P3-100/E	18	083964	P1-25/IVS/N	97
050969	P1-25/Z/SVA(A)	71	067324	T0-6-8370/IVS	102	084329	T0-2-1/IVS-RT	99
050970	P1-32/E/SVA(A)	20	067326	T0-6-15866/Z	85	084369	TM-2-8221/E	28
050971	P1-32/E/SVA(S)-RT	22	067327	T0-2-8242/E	41	086185	P3-100/IVS-RT	99
050974	SVA-T3	157	067330	T0-2-15403/E	19	086307	T0-3-8216/EZ	52
050975	SVC-T3	158	067337	T0-2-15921/Z	37	086312	T0-1-8220/Z	82, 89
050976	T0-2-1/E/SVA(A)	20	067351	P3-63/EA/SVB/N/H11	27	086315	T0-4-8223/Z	82
050977	T0-2-1/E/SVA(S)	21	067352	T0-1-8200/E	18	086316	T0-1-15451/Z	83

# Index - By article number

Article number	Part number	Page
086317	T0-1-15321/E	21
086333	P1-25/V/SVB/N	74
086334	T0-2-15679/V/SVB	76
086709	S-T0	157
086742	TM-3-8222/E	28
088558	P3-100/V/SVB	74
088682	T0-4-8440/EZ	59
088684	T0-3-8243/IVS	109
088685	T0-2-8230/E	42
088686	T0-3-8222/Z	82
088687	T0-2-1540/IVS	97
088690	T0-1-15321/EZ	50
088706	P1-25/V/SVB-SW/N	73
088707	T0-2-15679/V/SVB-SW	75
088709	T0-1-102/E	18
088710	P1-25/Z/N	70
089082	VR-T0	158
089115	TM-4-8223/E	28
090931	P5-125/Z	70
091047	T0-3-8401/E	35
091057	T0-3-8243/Z	88
091058	T0-2-8230/EZ	54, 65
091059	T0-5-8270/E	42
091060	T0-2-15404/Z	70
091062	T0-2-15452/E	33
091078	T0-1-102/EA/SVB	25
091079	P1-32/EA/SVB/N	25
091080	P1-25/EA/SVB/H11	27
091082	T0-1-102/EZ	49
091114	IVS-T0	113
091455	EZ-P1	46
091488	TM-5-8369/E	28
092025	T5B-4-8441/Z	84
092028	T5B-4-8441/E	34
092029	T5B-4-8440/Z	84
092032	T5B-4-8440/E	34
092049	T5B-4-8410/Z	87
092052	T5B-4-8410/E	38
092055	T5B-4-8344/V/SVB-SW	73
092056	T5B-4-8344/V/SVB	74
092061	T5B-4-8344/EA/SVB-SW	24
092062	T5B-4-8344/EA/SVB	25
092064	T5B-3-8344/E	18
092081	T5B-4-8294/Z	81
092084	T5B-4-8294/E	29
092105	T5B-4-8223/Z	82
092108	T5B-4-8223/E	31
092109	T5B-4-8213/Z	81
092112	T5B-4-8213/E	29
092288	T5B-3-8451/E	34
092293	T5B-3-8401/Z	85
092296	T5B-3-8401/E	35
092297	T5B-3-8342/Z	70
092299	T5B-3-8342/V/SVB-SW	73
092300	T5B-3-8342/V/SVB	74
092307	T5B-3-8342/EA/SVB-SW	24
092308	T5B-3-8342/EA/SVB	25
092310	T5B-3-8342/E	18
092374	T5B-3-8228/E	35
092375	T5B-3-8222/Z	82
092378	T5B-3-8222/E	31
092383	T5B-3-8212/Z	81
092386	T5B-3-8212/E	29
092918	T5B-2-8400/E	35
093044	T5B-2-8221/Z	82
093047	T5B-2-8221/E	31
093082	T5B-2-8211/Z	81
093094	T5B-2-8211/E	29
093303	P1-32/IVS	97
093420	T0-3-8401/EZ	60
093428	T0-4-8441/EZ	59
093432	T0-5-8270/EZ	65
093435	T0-2-15452/EZ	58
093436	T0-1-15321/IVS	98
093451	T0-1-102/EA/SVB-SW	24
093452	P1-32/EA/SVB-SW/N	24
093456	P1-32/E/N	18
093487	DE-T0	160
093828	H3-T0	46, 161
093861	TM-6-8370/E	28
093972	DE-P3	160
094258	T5B-1-8210/Z	81
094261	T5B-1-8210/E	29
094270	T5B-1-8200/Z	70
094273	T5B-1-8200/V/SVB	74
094278	T5B-1-8200/EA/SVB-SW	24
094279	T5B-1-8200/EA/SVB	25
094280	T5B-1-8200/E-RT	22
094281	T5B-1-8200/E	18
094460	T5B-1-102/Z	70
094462	T5B-1-102/V/SVB-SW	73
094463	T5B-1-102/V/SVB	74
094468	T5B-1-102/EA/SVB-SW	24
094469	T5B-1-102/EA/SVB	25
094470	T5B-1-102/E-RT	22
094471	T5B-1-102/E	18
095060	T3-2-8400/Z	85
095676	P1-32/V/SVB	74
095799	T0-1-8220/EZ	54, 65
095803	T0-3-8244/E	41
095804	T0-2-8230/IVS	110
095806	T0-1-15421/E	29
095809	T0-1-15321/Z	71
095813	T0-3-8007/E	37
095824	T0-1-102/V/SVB	74
095825	P1-32/V/SVB/N	74
095826	P1-25/V/SVB/H11	76
095828	T0-1-102/Z	70
095829	P1-32/EZ/N	49

Article number	Part number	Page
095958	T5-4-8344/V/SVB-SW	73
095959	T5-4-8344/V/SVB	74
095960	T5-4-8344/EA/SVB-SW	24
095961	T5-4-8344/EA/SVB	25
095984	T5-4-8294/Z	81
095986	T5-4-8294/E	29
096012	T5-4-8213/Z	81
096014	T5-4-8213/E	29
096234	TM-1-8210/E	28
096380	T5-3-8342/V/SVB-SW	73
096381	T5-3-8342/V/SVB	74
096382	T5-3-8342/EA/SVB-SW	24
096383	T5-3-8342/EA/SVB	25
096464	T5-3-8212/Z	81
096466	T5-3-8212/E	29
097225	T5-1-8200/E-RT	22
098049	P1-32/Z	70
098166	T0-3-8401/IVS	106
098176	T0-3-8244/EZ	64
098177	T0-2-8230/Z	89
098178	T0-5-8270/IVS	110
098179	T0-1-15421/EZ	52
098181	T0-2-15452/IVS	104
098186	T0-3-8007/EZ	62
098198	P1-32/V/SVB-SW/N	73
098199	P1-25/V/SVB-SW/H11	75
098607	TM-2-8211/E	28
098608	TM-1-8178/E	19
098807	T5-1-102/EA/SVB-SW	24
098808	T5-1-102/EA/SVB	25
105225	ZFS(*)P5	158
105854	CI-K1H-T0-2	94, 162
105855	CI-K1H-T0-4	94, 162
105859	CI-K2H-T3-4	94, 162
105860	CI-K2H-T3-5	94, 162
105870	I1H	151, 162
105871	I2H	151, 162
118742	MBS-I4	152
127267	P1-25/M4/SVB/H11	80
127268	P1-25/M4/SVB-SW/H11	79
127269	P1-25/M4/SVB/N/H11	80
127270	P1-25/M4/SVB-SW/N/H11	79
127271	P1-25/M4/K1-PR	78
127272	P1-25/M4/K1-PG	77
127273	P1-25/M4/K1-PR/N	78
127274	P1-25/M4/K1-PG/N	77
127275	P1-25/M4/K1-PR/H11	80
127276	P1-32/M4/K1-PG/H11	79
127277	P1-25/M4/K1-PR/N/H11	80
127278	P1-32/M4/K1-PR/N	77
127279	P1-32/M4/K1-PG/N	78
127280	P1-32/M4/K1-PR/H11	80
127281	P1-25/M4/K1-PG/H11	79
127282	P1-32/M4/K1-PR/N/H11	80
127283	P1-32/M4/K1-PG/N/H11	79
127284	P3-63/M4/SVB	78
127285	P3-63/M4/SVB-SW	77
127286	P3-63/M4/SVB/H11	80
127287	P3-63/M4/SVB-SW/H11	79
127289	P3-63/M4/SVB-SW/N/H11	79
127290	P3-63/M4/K2-PR	78
127291	P3-63/M4/K2-PG	77
127292	P3-63/M4/K2-PR/N	78
127293	P3-63/M4/K2-PG/N	77
127294	P3-63/M4/K2-PR/H11	80
127295	P3-63/M4/K1-PG/N/H11	79
127296	P3-63/M4/K2-PR/N/H11	80
127297	P3-63/M4/K1-PG/N/H11	79
127298	P3-100/M4/SVB	78
127299	P3-100/M4/SVB-SW	77
127300	P1-25/M4/SVB-SW/N/H11	79
127322	P3-100/M4/SVB/H11	80
127324	P3-100/M4/SVB/N/H11	80
127326	P3-100/M4/K2-PR	78
127327	P3-100/M4/K2-PG	77
127328	P3-100/M4/K2-PR/N	78
127329	P3-100/M4/K2-PG/N	77
127330	P3-100/M4/K2-PR/H11	80
127331	P3-100/M4/K1-PG/N/H11	79
127332	P3-100/M4/K2-PR/N/H11	80
127333	P3-100/M4/K1-PG/N/H11	79
127334	P1-25/XM	93
127335	P1-32/XM	93
127336	P3-63/XM	93
127337	P3-100/XM	93
127338	KNB-P1/M	93
127339	KNB-P3/M	93
127340	SVB-P1/M	93
127341	SVB-P3/M	93
127342	SVB-SW-P1/M	93
127343	SVB-SW-P3/M	93
127344	P1/P3-M400	93
127345	P1/P3-M600	93
127346	P1-25/M4/K1-PG/N/H11	79
127347	P1-32/M4/SVB	78
127348	P1-32/M4/SVB-SW	77
127349	P1-32/M4/SVB/N	78
127350	P1-32/M4/SVB-SW/N	77
127351	P1-32/M4/SVB/H11	80
127352	PL-32/M4/SVB-SW/N/H11	79
127353	PL-32/M4/SVB-SW/N/H11	80
127354	P1-32/M4/K1-PR	78
127355	P1-32/M4/K1-PG	77
127356	PL-25/M4/SVB	78
127357	PL-25/M4/SVB-SW	77
127358	PL-25/M4/SVB/N	78
127359	PL-25/M4/SVB-SW/N	77
127360	P1-25/M4/SVB	78
127361	P1-25/M4/SVB-SW	77
127362	P1-25/M4/SVB/N	78
127363	P1-25/M4/SVB-SW/N	77
127364	P1-25/M4/SVB/H11	80
127365	P1-25/M4/SVB-SW/H11	79
127366	P1-25/M4/SVB/N/H11	80
127367	P1-25/M4/SVB-SW/N/H11	79
127368	P1-25/M4/SVB	78
127369	P1-25/M4/SVB-SW	77
127370	P1-25/M4/SVB/N	78
127371	P1-25/M4/SVB-SW/N	77
127372	P1-25/M4/SVB/H11	80
127373	P1-25/M4/SVB-SW/H11	79
127374	P1-25/M4/SVB/N/H11	80
127375	P1-25/M4/SVB-SW/N/H11	79
127376	T0-2-1/SE1	117
127377	T0-2-1/SE1/SVB	128
127378	T0-2-1/SE1/SVB-SW	125
127379	T0-1-102/SE1	117
127380	T0-1-102/SE1/SVB	128
127381	T0-1-102/SE1/SVB-SW	125
127382	T0-1-8200/SE1	117
127383	T0-1-8200/SE1/SVB	128
127384	T0-1-8200/SE1/SVB-SW	125
127385	T0-1-8200/SE1/SVB	128
127386	T0-1-8200/SE1/SVB-SW	125
127387	T0-2-8211/SE1	137
127388	T0-3-8212/SE1	137
127389	T0-4-8213/SE2	137
127390	T0-1-8214/SE1	137
127391	T0-2-8215/SE1	137
127392	T0-3-8216/SE1	137
127393	T0-1-8220/SE1	138
127394	T0-2-8221/SE1	138
127395	T0-3-8222/SE1	138
127396	T0-3-8223/SE2	138
127408	T0-3-8342/SE1	117
127409	T0-3-8342-SE1/SVB	128
127410	T0-3-8342/SE1/SVB-SW	125
127411	T0-4-8344/SE2	117
127412	T0-4-8344/SE2/SVB	128
127413	T0-4-8344/SE2/SVB-SW	125
127420	T0-2-8900/SE1	117
127421	T0-2-8900/SE1/SVB	128
127422	T0-2-8900/SE1/SVB-SW	125
127430	T0-1-15431/SE1	137
127431	T0-2-15432/SE1	137
127432	T0-3-15433/SE1	137
127440	T0-2-15679/SE1	122
127441	T0-2-15679/SE1/SVB	134
127442	T0-2-15679/SE1/SVB-SW	131
127443	T0-3-15680/SE1	122
127444	T0-3-15680/SE1/SVB	134
127445	T0-3-15680/SE1/SVB-SW	131
127446	T0-4-15682/SE2	122
127447	T0-4-15682/SE2/SVB	134
127448	T0-4-15682/SE2/SVB-SW	131
127449	T0-3-15683/SE1	122
127450	T0-3-15683/SE1/SVB	134
127451	T0-3-15683/SE1/SVB-SW	131
127456	T3-3-8342/SE1	117

Article number	Part number	Page
1818030	K1DR/P	93
1818031	K1DGP	93
1818032	K2SDB/P	93
1818033	K2SDR/P	93
1818034	K2SDG/P	93
1818038	K2SDB/C	93
1818039	K2SDR/C	93
1818040	K2SDG/C	93
182413	P1-25/I2H/MBS/SVB	127
182414	P1-25/I2H/MBS/SVB-SW	124
182415	P1-25/I2H/MBS/SVB/H11	133
182416	P1-25/I2H/MBS/SVB-SW/H11	130
182417	P1-32/I2H/MBS/SVB	127
182418	P1-32/I2H/MBS/SVB-SW	124
182419	P1-32/I2H/MBS/SVB/H11	133
182420	P1-32/I2H/MBS/SVB-SW/H11	130
182421	P3-63/I4/MBS/SVB	127
182422	P3-63/I4/MBS/SVB-SW	124
182423	P3-63/I4/MBS/SVB/H11	133
182424	P3-63/I4/MBS/SVB-SW/H11	130
182425	T0-2-1/I2H/MBS/SVB	127
182426	T0-2-1/I2H/MBS/SVB-SW	124
182427	T0-2-8900/I2H/MBS/SVB	127
182428	T0-2-8900/I2H/MBS/SVB-SW	124
182429	T0-2-15679/I2H/MBS/SVB	133
182430	T0-2-15679/I2H/MBS/SVB-SW	130
182431	T0-3-15680/I2H/MBS/SVB	133
182432	T0-3-15680/I2H/MBS/SVB-SW	130
182433	T0-3-15683/I2H/MBS/SVB	133
182434	T0-3-15683/I2H/MBS/SVB-SW	130
182435	T0-4-15682/I2H/MBS/SVB	133
182436	T0-4-15682/I2	

# Index - By article number

Article number	Part number	Page	Article number	Part number	Page	Article number	Part number	Page
197457	T3-3-8342/SE2/SVB	128	207081	T0-2-111	116	207211	T3-4-15682/2/SVB-SW	129
197458	T3-3-8342/SE1/SVB-SW	125	207082	T0-2-111-RT	120	207212	T3-4-8344/2/SVB	126
197459	T3-4-8344/SE2	117	207083	T0-2-111/SVA(A)	118	207213	T3-4-8344/2/SVB-SW	123
197460	T3-4-8344/SE2/SVB	128	207084	T0-2-111/SVA(S)	118	207214	T5-4-8902/5	135
197461	T3-4-8344/SE2/SVB-SW	125	207085	T0-2-111/SVA(S)-RT	120	207215	T5B-1-102/4	116
197472	T3-4-15682/SE2	122	207086	T0-2-111/SVC(S)-RT	120	207218	T5B-1-8200/4	116
197473	T3-4-15682/SE2-SVB	134	207087	T0-2-15323/1	119	207220	T5B-2-821/4	135
197474	T3-4-15682/SE2/SVB-SW	131	207088	T0-2-15403/1	116	207221	T5B-2-822/4	136
197475	T3-3-15683/SE2	122	207089	T0-2-1540/1	116	207222	T5B-2-8400/4	142
197476	T3-3-15683/SE2/SVB	134	207090	T0-2-15422/1	135	207223	T5B-3-8212/4	135
197477	T3-3-15683/SE2/SVB-SW	131	207091	T0-2-15432/1	140	207224	T5B-3-8222/4	136
199888	P1-40/XM	93	207092	T0-2-15452/1	140	207225	T5B-3-8228/4	142
199889	P1-40/E	18	207093	T0-2-15512/1	119	207226	T5B-3-8342/4	116
199891	P1-40/E/N	18	207094	T0-2-15679/1	121	207227	T5B-3-8401/4	142
199894	P1-40/EA/SVB	25	207095	T0-2-15907/1	140	207228	T5B-3-8451/4	141
199895	P1-40/EA/SVB/HI11	27	207101	T0-2-8177/1	119	207229	T5B-4-15682/4	121
199896	P1-40/EA/SVB/N	25	207102	T0-2-8211/1	135	207230	T5B-4-8213/4	135
199897	P1-40/EA/SVB/N/HI11	27	207103	T0-2-8215/1	136	207231	T5B-3-8223/4	136
199898	P1-40/EA/SVB-SW	24	207104	T0-2-8221/1	136	207232	T5B-4-8294/4	135
199899	P1-40/EA/SVB-SW/HI11	26	207105	T0-2-8230/1	148	207233	T5B-3-8344/4	116
199900	P1-40/EA/SVB-SW/N	24	207106	T0-2-8231/1	148	207234	T5B-4-8410/4	147
199901	P1-40/EA/SVB-SW/N/HI11	26	207107	T0-2-8241/1	148	207235	T5B-4-8440/4	141
199902	P1-40/E-RT	22	207108	T0-2-8242/1	148	207236	T5B-4-8441/4	141
199903	P1-40/EZ	49	207109	T0-2-8900/1	116	207237	T5B-4-8902/4	135
199904	P1-40/EZ/N	49	207110	T0-2-8900/1-RT	120	207238	T5B-1-102/4/SVB	126
199906	P1-40/I2	116	207111	T0-2-8400/1	142	207239	T5B-1-102/4/SVB-SW	123
199908	P1-40/N	116	207112	T0-3-15391/1	150	207240	T5B-1-8200/4/SVB	126
199909	P1-40/I2/SVB	126	207113	T0-3-15394/1	150	207241	T5B-1-8200/4/SVB-SW	123
199910	P1-40/I2/SVB/HI11	132	207114	T0-3-15423/1	135	207242	T5B-3-8342/4/SVB	126
199911	P1-40/I2/SVB/N	126	207115	T0-3-15433/1	140	207243	T5B-3-8342/4/SVB-SW	123
199912	P1-40/I2/SVB-SW	123	207116	T0-3-15453/1	140	207244	T5B-3-8901/4/SVB	132
199913	P1-40/I2/SVB-SW/HI11	129	207117	T0-3-15513/1	119	207245	T5B-3-8901/4/SVB-SW	129
199914	P1-40/I2/SVB-SW/N	123	207118	T0-3-15683/1	121	207246	T5B-4-15682/4/SVB	132
199915	P1-40/I2H	116	207119	T0-3-15924/1	146	207247	T5B-4-15682/4/SVB-SW	129
199916	P1-40/I2H/HI11	121	207120	T0-3-8007/1	146	207248	T5B-4-8344/4/SVB	126
199917	P1-40/I2H/MBS/SVB	127	207123	T0-3-8212/1	135	207249	T5B-4-8344/4/SVB-SW	123
199918	P1-40/I2H/MBS/SVB/HI11	133	207124	T0-3-8222/1	136, 148	207250	T5B-3-8342/4-SI	144
199919	P1-40/I2H/MBS/SVB-SW	124	207125	T0-3-8228/1	142	207251	T5B-3-8342/4-SI-SW	143
199920	P1-40/I2H/MBS/SVB-SW/HI11	130	207126	T0-3-8232/1	148	207254	T5B-4-15682/4-SI	144
199921	P1-40/I2H/N	116	207127	T0-3-8233/1	148	207255	T5B-4-15682/4-SI-SW	143
199922	P1-40/I2H/SVB	126	207128	T0-3-8243/1	148	207258	T5B-4-8903/4-SI	144
199923	P1-40/I2H/SVB/HI11	132	207129	T0-3-8244/1	148	207259	T5B-4-8903/4-SI-SW	143
199924	P1-40/I2H/SVB/N	126	207130	T0-3-8280/1	148	207266	T5-3-8212/5	135
199925	P1-40/I2H/SVB-SW	123	207131	T0-3-8342/1	116	207269	T5-4-15682/5	121
199926	P1-40/I2H/SVB-SW/HI11	129	207132	T0-3-8401/1	142	207270	T5-4-8213/5	135
199927	P1-40/I2H/SVB-SW/N	123	207133	T0-3-8451/1	141	207273	T5-1-102/5/SVB	126
199930	P1-40/I2-RT	120	207134	T0-4-15602/1	139	207277	T5-3-8901/5/SVB	132
199931	P1-40/IVS	97	207136	T0-4-8213/1	135	207278	T5-3-8901/5/SVB-SW	129
199933	P1-40/IVS/N	97	207137	T0-4-8223/1	136	207279	T5-3-8342/5/SVB	126
199935	P1-40/IVS-RT	99	207138	T0-4-8294/1	135	207280	T5-3-8342/5/SVB-SW	123
199936	P1-40/M4/SVB	78	207139	T0-4-8344/1	116	207281	T5-4-15682/5/SVB	132
199937	P1-40/M4/SVB/HI11	80	207140	T0-4-8410/1	147	207282	T5-4-15682/5/SVB-SW	129
199938	P1-40/M4/SVB/N	78	207141	T0-4-8440/1	141	207283	T5-4-8344/5/SVB	126
199939	P1-40/M4/SVB/N/HI11	80	207142	T0-4-8441/1	141	207284	T5-4-8344/5/SVB-SW	123
199940	P1-40/M4/SVB-SW	77	207143	T0-1-1021/1/SVB	126	207285	T5-4-15682/5-SI	144
199941	P1-40/M4/SVB-SW/HI11	79	207144	T0-1-1021/1/SVB-SW	123	207286	T5-4-15682/5-SI-SW	143
199942	P1-40/M4/SVB-SW/N	77	207145	T0-1-8200/1/SVB	126	207289	T5-4-8903/5-SI	144
199943	P1-40/M4/SVB-SW/N/HI11	79	207146	T0-1-8200/1/SVB-SW	123	207290	T5-4-8903/5-SI-SW	143
199944	P1-40/SE1	117	207147	T0-2-111/SVB	126	207293	P1-25/2/SVB	126
199945	P1-40/SE1/N	117	207148	T0-2-111/SVB-SW	123	207294	P1-25/2/SVB-SW	123
199946	P1-40/SE1/SVB	128	207149	T0-2-15679/1/SVB	132	207295	P1-25/2/SVB-SW/HI11	129
199947	P1-40/SE1/SVB/HI11	134	207150	T0-2-15679/1/SVB-SW	129	207296	P1-25/2/SVB-SW/N	123
199948	P1-40/SE1/SVB/N	128	207151	T0-2-8900/1/SVB	126	207297	P1-25/2/SVB/HI11	132
199949	P1-40/SE1/SVB-SW	125	207152	T0-2-8900/1/SVB-SW	123	207298	P1-25/2/SVB/N	126
199950	P1-40/SE1/SVB-SW/HI11	131	207153	T0-3-15680/1/SVB	132	207299	P1-25/2	116
199951	P1-40/SE1/SVB-SW/N	125	207154	T0-3-15680/1/SVB-SW	129	207300	P1-25/2-RT	120
199952	P1-40/V/SVB	74	207157	T0-3-15683/1/SVB	132	207303	P1-25/2/N	116
199953	P1-40/V/SVB/HI11	76	207158	T0-3-15683/1/SVB-SW	129	207304	P1-25/2/SVA(A)	118
199955	P1-40/V/SVB/N	74	207159	T0-3-8342/1/SVB	126	207305	P1-25/2/SVA(S)	118
199956	P1-40/V/SVB/N/HI11	76	207160	T0-3-8342/1/SVB-SW	123	207306	P1-25/2/SVA(S)-RT	120
199958	P1-40/V/SVB-SW	73	207161	T0-4-15682/1/SVB	132	207307	P1-25/2/SVC(S)-RT	120
199959	P1-40/V/SVB-SW/HI11	75	207162	T0-4-15682/1/SVB-SW	129	207313	P1-25/2-SI	144
199961	P1-40/V/SVB-SW/N	73	207163	T0-4-8344/1/SVB	126	207328	P1-32/2/SVC(S)-RT	120
199962	P1-40/V/SVB-SW/N/HI11	75	207164	T0-4-8344/1/SVB-SW	123	207309	P1-25/2-SI-SW	143
199964	P1-40/Z	70	207165	T3-1-102/2	116	207310	P1-25/2-SI/HI11	144
199966	P1-40/Z/N	70	207166	T3-1-102/2-RT	120	207311	P1-25/2-SI/HI11-SW	143
200127	T6-160-15682/V/SVB-SW/HI11	75	207167	T3-1-8200/2	116	207312	P1-25/2-SI/N	144
200128	T8-3-8342/V/SVB-SW/HI11	75	207169	T3-1-8210/2	135	207313	P1-25/2-SI/N-SW	143
200184	H-T8	161	207178	T3-2-8211/2	135	207314	P1-32/2/SVB	126
200619	T6-160-15682/V/SVB/HI11	76	207179	T3-2-8215/2	136	207315	P1-32/2/SVB-SW	123
200620	T8-3-8342/V/SVB/HI11	76	207180	T3-2-8221/2	136	207316	P1-32/2/SVB-SW/HI11	129
201447	T6-160-6/45/SVB-SW/HI11	129	207181	T3-2-8400/2	142	207317	P1-32/2/SVB-SW/N	123
201448	T6-160-6/45/SVB/HI11	132	207182	T3-3-15683/2	121	207318	P1-32/2/SVB/HI11	132
201449	T8-3-8342/48/SVB-SW/HI11	129	207183	T3-3-8212/2	135	207319	P1-32/2/SVB/N	126
201450	T8-3-8342/48/SVB/HI11	132	207184	T3-3-8216/2	136	207320	P1-32/2	116
205548	ZFS80-T0	156	207185	T3-3-8222/2	136	207321	P1-32/2-RT	120
205565	ZFS80-P3	156	207186	T3-3-8228/2	142	207324	P1-32/2/N	116
206911	V-M25	151	207187	T3-3-8342/2	116	207325	P1-32/2/SVA(A)	118
206914	AB-Cl-K4/5	151, 163	207188	T3-3-8401/2	142	207326	P1-32/2/SVA(S)	118
206916	K-Cl-K4	151, 163	207189	T3-3-8451/2	141	207329	P1-32/2-SI	144
207061	T0-1-102/1	116	207190	T3-4-15682/2	121	207330	P1-32/2-SI-SW	143
207062	T0-1-102/1-RT	120	207191	T3-4-8213/2	135	207331	P1-32/2-SI/HI11	144
207063	T0-1-102/1/S	118	207192	T3-4-8223/2	136	207332	P1-32/2-SI/HI11-SW	143
207064	T0-1-15321/1	119	207193	T3-4-8294/2	135	207333	P1-32/2-SI/N	144
207065	T0-1-15322/1	119	207194	T3-4-8344/2	116	207334	P1-32/2-SI/N-SW	143
207067	T0-1-15401/1	119	207195	T3-4-8410/2	147	207343	P3-63/4/SVB	126
207068	T0-1-15402/1	119	207196	T3-4-8440/2	141	207344	P3-63/4/SVB-SW	123
207069	T0-1-15421/1	135	207197	T3-4-8441/2	141	207345	P3-63/4/SVB-SW/HI11	129
207070	T0-1-15431/1	140	207198	T3-1-102/2/SVB	126	207346	P3-63/4/SVB-SW/N	123
207071	T0-1-15434/1	140	207199	T3-1-102/2/SVB-SW	123	207347	P3-63/4/SVB-SW/N/HI11	129
207072	T0-1-15451/1	140	207200	T3-1-8200/2/SVB	126	207348	P3-63/4/SVB/HI11	132
207073	T0-1-15511/1	119	207201	T3-1-8200/2/SVB-SW	123	207349	P3-63/4/SVB/N	126
207074	T0-1-8200/1	116	207202	T3-3-15680/2/SVB	129	207350	P3-63/4/SVB/N/HI11	132
207075	T0-1-8200/1-RT	120	207203	T3-3-15680/2/SVB-SW	129	207356	P3-63/4	116
207076	T0-1-8210/1	135	207206	T3-3-15683/2/SVB	132	207357	P3-63/4-RT	116
207077	T0-1-8214/1	136	207207	T3-3-15683/2/SVB-SW	129	207360	P3-63/4/N	120
207078	T0-1-8220/1	136, 148	207208	T3-3-8342/2/SVB	126	207361	P3-63/4-SI	144
207079	T0-1-8240/1	148	207209	T3-3-8342/2/SVB-SW	123	207362	P3-63/4-SI-SW	143
207080	T0-1-91/1	149	207210	T3-4-15682/2/SVB	132	207363	P3-63/4-SI/HI11	144

# Index - By article number

Article number	Part number	Page	Article number	Part number	Page	Article number	Part number	Page
207364	P3-63/4-SI/1H11-SW	143	207537	T3-2-15876/2	142	280924	P5-160/EA/SVB/N	25
207365	P3-63/4-SI/N	144	207603	KT-M25	151	280925	P5-160/EA/SVB-SW	24
207366	P3-63/4-SI/N-SW	144	208261	TM-1-SOND-ERSTBESTELLUNG/E	173	280926	P5-160/EA/SVB-SW/H10	26
207373	P3-100/5/SVB	126	208262	TM-1-SOND-ERSTBESTELLUNG/EZ	173	280927	P5-160/EA/SVB-SW/N	24
207374	P3-100/5/SVB-SW	123	208263	TM-2-SOND-ERSTBESTELLUNG/E	173	280928	P5-160/VSVB	74
207375	P3-100/5/SVB-SW/H11	129	208264	TM-2-SOND-ERSTBESTELLUNG/EZ	173	280929	P5-160/VSVB/H10	76
207376	P3-100/5/SVB-SW/N	123	208265	TM-3-SOND-ERSTBESTELLUNG/E	173	280930	P5-160/VSVB/N	74
207377	P3-100/5/SVB-SW/N/H11	129	208266	TM-3-SOND-ERSTBESTELLUNG/EZ	173	280931	P5-160/VSVB-SW	73
207378	P3-100/5/SVB/H11	132	208267	TM-4-SOND-ERSTBESTELLUNG/E	173	280932	P5-160/VSVB-SW/H10	75
207379	P3-100/5/SVB/N	126	208268	TM-4-SOND-ERSTBESTELLUNG/EZ	173	280933	P5-160/VSVB-SW/N	73
207380	P3-100/5/SVB/N/H11	132	208269	TM-5-SOND-ERSTBESTELLUNG/E	173	280934	P5-160/Z	70
207381	P3-100/5	116	208270	TM-5-SOND-ERSTBESTELLUNG/EZ	173	280935	P5-250/E	18
207382	P3-100/5-RT	120	208271	TM-6-SOND-ERSTBESTELLUNG/E	173	280936	P5-250/EA/SVB	25
207385	P3-100/5/N	116	208272	TM-6-SOND-ERSTBESTELLUNG/EZ	173	280937	P5-250/EA/SVB/H10	27
207386	P3-100/5-SI	144	208273	TM-7-SOND-ERSTBESTELLUNG/E	173	280938	P5-250/EA/SVB/N	25
207387	P3-100/5-SI-SW	143	208274	TM-7-SOND-ERSTBESTELLUNG/EZ	173	280939	P5-250/EA/SVB-SW	24
207388	P3-100/5-SI/H11	144	208275	TM-8-SOND-ERSTBESTELLUNG/E	173	280940	P5-250/EA/SVB-SW/H10	26
207389	P3-100/5-SI/H11-SW	143	208276	TM-8-SOND-ERSTBESTELLUNG/EZ	173	280941	P5-250/EA/SVB-SW/N	24
207390	P3-100/5-SI/N	144	213949	T3-2-8901/E	23	280942	P5-250/VSVB	74
207391	P3-100/5-SI/N-SW	143	214781	T6-3-8212/E/H12	29	280943	P5-250/VSVB/H10	76
207398	T0-2-8900/E	18	214782	T8-3-8212/E/H12	29	280944	P5-250/VSVB/N	74
207399	T0-2-8900/E-RT	22	214785	T5B-5-15876/E	36	280945	P5-250/VSVB-SW	73
207400	T0-2-8900/EA/SVB	25	214786	T5B-5-15876/Z	85	280946	P5-250/VSVB-SW/H10	75
207401	T0-2-8900/EA/SVB-SW	24	214788	T5B-7-15866/E	36	280947	P5-250/VSVB-SW/N	73
207402	T0-2-8900/EZ	49	215222	T3-4-8902/E	29	280948	P5-250/Z	70
207403	T0-2-8900/IVS	97	215223	T3-4-8902/EZ	52	280949	P5-315/E	18
207404	T0-2-8900/IVS-RT	99	215224	T3-4-8902/I2	135	280950	P5-315/EA/SVB	25
207405	T0-2-8900/IVS/B	74	215225	T3-4-8902/Z	81	280951	P5-315/EA/SVB/H10	27
207406	T0-2-8900/IVS/B-SW	73	218488	K-CI-K5	151, 163	280952	P5-315/EA/SVB/N	25
207407	T0-2-8900/Z	70	218971	T0-2-15435/11	140	280953	P5-315/EA/SVB-SW	24
207408	T5-3-8901/EA/SVB	27	218984	T0-4-8251/11	148	280954	P5-315/EA/SVB-SW/H10	26
207409	T5-3-8901/EA/SVB-SW	26	218987	T3-3-8901/I2/SVB	132	280955	P5-315/EA/SVB-SW/N	24
207412	T5-4-15682/E	23	218988	T3-3-8901/I2/SVB-SW	129	280956	P5-315 kW/VSVB	74
207413	T5-4-15682/EA/SVB	27	225325	CI-K2-T3-4	94, 162	280957	P5-315/VSVB/H10	76
207414	T5-4-15682/EA/SVB-SW	26	225342	TM-1-15431/IVS	104	280958	P5-315 kW/VSVB/N	74
207415	T5-4-15682/V/SVB	76	225346	TM-1-SOND*/IVS	173	280959	P5-315/VSVB-SW	73
207416	T5-4-15682/V/SVB-SW	75	225347	TM-1-SOND-ERSTBESTELLUNG/IVS	173	280960	P5-315/VSVB-SW/H10	75
207417	T5-4-15682/Z	72	225348	TM-2-SOND*/IVS	173	280961	P5-315/VSVB-SW/N	73
207418	T5-4-8902/E	29	225349	TM-2-SOND-ERSTBESTELLUNG/IVS	173	280962	P5-315/Z	70
207419	T5-4-8902/Z	81	226898	P1-25/2H	116	280963	H121-P5-125/160E	45, 160
207420	T5B-3-8901/EA/SVB	27	226899	P1-25/2H/H11	121	280964	H121-P5-125/160Z	92, 160
207421	T5B-3-8901/EA/SVB-SW	26	226900	P1-25/2H/SVB	126	280965	H121-P5-250/315E	45, 160
207422	T5B-3-8901/IVS/B	76	226901	P1-25/2H/N	116	280966	H121-P5-250/315Z	92, 160
207423	T5B-3-8901/IVS/B-SW	75	226902	P1-25/2H/VSVB/H11	129, 132	280969	N-P5-125/160E	45, 159
207424	T5B-4-15682/E	23	227860	P1-25/2H/SVB/N	126	280970	N-P5-125/160Z	91, 159
207425	T5B-4-15682/EA/SVB	27	227861	P1-25/2H/VSVB-SW	123	280971	N-P5-250/315E	45, 159
207426	T5B-4-15682/EA/SVB-SW	26	227862	P1-25/2H/VSVB-SW/H11	129	280972	N-P5-250/315Z	91, 159
207427	T5B-4-15682/V/SVB	76	227863	P1-25/2H/VSVB-SW/N	123	280973	PE-P5-125/160E	45, 159
207428	T5B-4-15682/V/SVB-SW	75	227866	P1-32/2H	116	280974	PE-P5-125/160Z	91, 159
207429	T5B-4-15682/Z	72	227867	P1-32/2H/H11	121	280975	PE-P5-250/315E	45, 159
207430	T5B-4-8902/E	29	227868	P1-32/2H/SVB	126	280976	PE-P5-250/315Z	91, 159
207431	T5B-4-8902/Z	81	227869	P1-32/2H/N	116, 123	280978	ST-P5-250/314	162
207432	T5B-1-8210/I4	135	227870	P1-32/2H/VSVB/H11	123	280979	ZAV-P5	92
207433	T5-4-8294/I5	135	227871	P1-32/2H/SVB/N	126	290191	MBS-I2	152
207434	T0-3-8216/I1	136	227872	P1-32/2H/VSVB-SW	123	293977	H-P5-125/160	161
207435	CI-K1-T0-2	94, 162	227873	P1-32/2H/VSVB-SW/H11	129	293978	H-P5-250/315	161
207436	CI-K1-T0-4	94, 162	227874	P1-32/2H/VSVB-SW/N	123	400000	T0-4-74949GB/E	35
207437	CI-K2-T3-2	94, 162	228291	T0-2-1/E(SVA(S)-RT	22	400001	T3-4-74949GB/E	35
207438	CI-K2-T3-5	94, 162	231893	FS(*)-T0	155	400002	T5B-4-74949GB/E	35
207439	CI-K4-T5B-2	46, 162	231895	FS(*)-P3	155	400136	FORKTERM-P1	157
207440	CI-K4-T5B-4	94, 162	231932	T0-3-8901/EA/SVB	27	907745	SVA(*)-T3	159
207441	CI-K5-T5-2	94, 162	231933	T0-3-8901/EA/SVB-SW	26	907748	SVC(*)-T3	158
207442	CI-K5-T5-4	94, 162	231934	T0-3-8901/I1/SVB	132	907749	TM-1-SOND*/E	173
207447	T5-3-8342/I5-SI	144	231935	T0-3-8901/I1/SVB-SW	129	907750	TM-3-SOND*/E	173
207448	T5-3-8342/I5-SI-SW	143	231938	T0-2-8901/E	23	907751	TM-4-SOND*/E	173
207451	K-CI-K1/I2	151, 163	231939	T0-3-8901/EZ	51	907752	TM-6-SOND*/E	173
207480	T0-1-SOND*/I1	165	231940	T0-3-8901/IVS	100	907753	TM-7-SOND*/E	173
207481	T0-1-SOND*/I1/SVB	165	231941	T0-3-8901/I1	121	907754	TM-8-SOND*/E	173
207482	T0-1-SOND*/I1/SVB-SW	165	231945	T3-3-8901/EA/SVB	27	907755	TM-1-SOND*/E	173
207483	T0-2-SOND*/I1	165	231946	T3-3-15680/EA/SVB-SW	26	907756	TM-2-SOND*/EZ	173
207484	T0-2-SOND*/I1/SVB	165	231950	T3-3-8901/EZ	51	907757	TM-3-SOND*/EZ	173
207485	T0-2-SOND*/I1/SVB-SW	165	231951	T3-3-8901/I2	121	907758	TM-4-SOND*/EZ	173
207486	T0-3-SOND*/I1	165	231952	T3-3-8901/Z	72	907759	TM-5-SOND*/EZ	173
207487	T0-3-SOND*/I1/SVB	165	231957	S-SOND-KMS(*)-T0	157	907760	TM-6-SOND*/EZ	173
207488	T0-3-SOND*/I1/SVB-SW	165	231959	S(*)-T0	157	907761	TM-7-SOND*/EZ	173
207489	T0-4-SOND*/I1	165	231965	S(*)-SOND-SA(*)-T0	157	907762	TM-8-SOND*/EZ	173
207490	T0-4-SOND*/I1/SVB	165	231967	SVA-SOND-KMS(*)-T3	157	907763	TM-2-SOND*/E	173
207491	T0-4-SOND*/I1/SVB-SW	165	231971	SVA(*)-SOND-SA(*)-T3	157	907764	TM-5-SOND*/E	173
207492	T3-5-SOND*/I2	167, 168	231972	ES-KMS1-T0	158	907765	T0-1-SOND*/E	165
207493	T3-5-SOND*/I2/SVB	167, 168	231973	ES-KMS(*)-T0	158	907766	T0-2-SOND*/E	165
207494	T3-5-SOND*/I2/SVB-SW	167, 168	232034	IVS/S-A	113	907767	T0-3-SOND*/E	165
207498	T4-1-SOND*/I2	167	232036	IVS/S-B	113	907768	T0-4-SOND*/E	165
207499	T4-1-SOND*/I2/SVB	167	232038	IVS/S-F	113	907769	T0-5-SOND*/E	166
207500	T4-1-SOND*/I2/SVB-SW	167	232040	IVS/S-E	113	907770	T0-6-SOND*/E	166
207510	T5B-1-SOND*/I4	169	232042	IVS/S-R	113	907771	T0-7-SOND*/E	166
207511	T5B-1-SOND*/I4/SVB	169	232043	IVS/S-G	113	907772	T0-8-SOND*/E	166
207512	T5B-1-SOND*/I4/SVB-SW	169	254546	ZAV(X1)+ZV(X1)-T0/P3	92	907773	T0-9-SOND*/E	166
207514	T5B-2-SOND*/I4	169	256151	HS-SA(*)-T0	158	907774	T0-10-SOND*/E	166
207515	T5B-2-SOND*/I4/SVB	169	266905	FS-ALU980-T0	155	907775	T0-11-SOND*/E	166
207516	T5B-2-SOND*/I4/SVB-SW	169	266906	FS-ALU980-P3	155	907776	T0-1-SOND*/EA/SVB	165
207518	T5B-3-SOND*/I4	169	269462	CI-KZH-T3-2	94, 162	907777	T0-2-SOND*/EA/SVB	165
207519	T5B-3-SOND*/I4/SVB	169	207135	T0-4-15682/I1	121	907778	T0-3-SOND*/EA/SVB	165
207520	T5B-3-SOND*/I4/SVB-SW	169	280897	P5-125/E	18	907779	T0-4-SOND*/EA/SVB	165
207521	T5B-4-SOND*/I4	169	280898	P5-125/EA/SVB	25	907787	T0-1-SOND*/EZ	165
207522	T5B-4-SOND*/I4/SVB	169	280899	P5-125/EA/SVB/H10	27	907788	T0-2-SOND*/EZ	165
207523	T5B-4-SOND*/I4/SVB-SW	169	280910	P5-125/EA/SVB/N	25	907789	T0-3-SOND*/EZ	165
207524	T5-1-SOND*/I4	171	280911	P5-125/EA/SVB-SW	24	907790	T0-4-SOND*/EZ	165
207525	T5-1-SOND*/I4/SVB	171	280912	P5-125/EA/SVB-SW/H10	26	907791	T0-5-SOND*/EZ	166
207526	T5-1-SOND*/I4/SVB-SW	171	280913	P5-125/EA/SVB-SW/N	24	907792	T0-6-SOND*/EZ	166
207527	T5-2-SOND*/I4	171	280914	P5-125/IVS/B	74	907793	T0-7-SOND*/EZ	166
207528	T5-2-SOND*/I4/SVB	171	280915	P5-125/IVS/B/H10	76	907794	T0-8-SOND*/EZ	166
207529	T5-2-SOND*/I4/SVB-SW	171	280916	P5-125/IVS/B/N	74	907795	T0-9-SOND*/EZ	166
207530	T5-3-SOND*/I4	171	280917	P5-125/IVS/B-SW	73	907796	T0-10-SOND*/EZ	166
207531	T5-3-SOND*/I4/SVB	171	280918	P5-125/IVS/B-SW/H10	75	907797	T0-11-SOND*/EZ	166
207532	T5-3-SOND*/I4/SVB-SW	171	280919	P5-125/IVS/B-SW/N	73	907806	T0-1-SOND*/IVS	165
207533	T5-4-SOND*/I4	171	280920	P3-100/Z	70	907807	T0-2-SOND*/IVS	165
207534	T5-4-SOND*/I4/SVB	171	280921	P5-160/E	18	907808	T0-3-SOND*/IVS	165
207535	T5-4-SOND*/I4/SVB-SW	171	280922	P5-160/EA/SVB	25	907809	T0-4-SOND*/IVS	165
207536	T3-5-8369/I2	136	280923	P5-160/EA/SVB/H10	27	907810	T0-5-SOND*/IVS	166

# Index - By article number

Article number	Part number	Page
907811	T0-6-SOND*/IVS	166
907812	T0-7-SOND*/IVS	166
907813	T0-8-SOND*/IVS	166
907814	T0-9-SOND*/IVS	166
907815	T0-10-SOND*/IVS	166
907816	T0-11-SOND*/IVS	166
907817	T0-1-SOND*/IV/SVB	165
907818	T0-2-SOND*/IV/SVB	165
907819	T0-3-SOND*/IV/SVB	165
907820	T0-4-SOND*/IV/SVB	165
907839	T0-1-SOND*/Z	165
907840	T0-2-SOND*/Z	165
907841	T0-3-SOND*/Z	165
907842	T0-4-SOND*/Z	165
907843	T0-5-SOND*/Z	166
907844	T0-6-SOND*/Z	166
907845	T0-7-SOND*/Z	166
907846	T0-8-SOND*/Z	166
907847	T0-9-SOND*/Z	166
907848	T0-11-SOND*/Z	166
907849	T0-11-SOND*/Z	166
907850	T3-5-SOND*/E	167, 168
907852	T3-1-SOND*/E	167
907855	T3-6-SOND*/E	168
907856	T3-7-SOND*/E	168
907857	T3-8-SOND*/E	168
907858	T3-9-SOND*/E	168
907859	T3-10-SOND*/E	168
907860	T3-11-SOND*/E	168
907861	T3-5-SOND*/EA/SVB	167, 168
907863	T4-1-SOND*/EA/SVB	167
907866	T3-6-SOND*/EA/SVB	168
907872	T3-5-SOND*/EZ	167, 168
907874	T4-1-SOND*/EZ	167
907877	T3-6-SOND*/EZ	168
907878	T3-7-SOND*/EZ	168
907879	T3-8-SOND*/EZ	168
907880	T3-9-SOND*/EZ	168
907881	T3-10-SOND*/EZ	168
907882	T3-11-SOND*/EZ	168
907891	T3-5-SOND*/IV/SVB	167, 168
907893	T4-1-SOND*/IV/SVB	167
907896	T3-6-SOND*/IV/SVB	168
907913	T3-5-SOND*/Z	167, 168
907915	T4-1-SOND*/Z	167
907918	T3-6-SOND*/Z	168
907919	T3-7-SOND*/Z	168
907920	T3-8-SOND*/Z	168
907921	T3-9-SOND*/Z	168
907922	T3-10-SOND*/Z	168
907923	T3-11-SOND*/Z	168
907924	T5B-1-SOND*/E	169
907925	T5B-2-SOND*/E	169
907926	T5B-3-SOND*/E	169
907927	T5B-4-SOND*/E	169
907928	T5B-5-SOND*/E	170
907929	T5B-6-SOND*/E	170
907930	T5B-7-SOND*/E	170
907931	T5B-8-SOND*/E	170
907932	T5B-9-SOND*/E	170
907933	T5B-10-SOND*/E	170
907934	T5B-1-SOND*/EA/SVB	169
907935	T5B-2-SOND*/EA/SVB	169
907936	T5B-3-SOND*/EA/SVB	169
907937	T5B-4-SOND*/EA/SVB	169
907938	T5B-5-SOND*/EA/SVB	170
907939	T5B-6-SOND*/EA/SVB	170
907940	T5B-7-SOND*/EA/SVB	170
907941	T5B-8-SOND*/EA/SVB	170
907950	T5B-1-SOND*/IV/SVB	169
907951	T5B-2-SOND*/IV/SVB	169
907952	T5B-3-SOND*/IV/SVB	169
907953	T5B-4-SOND*/IV/SVB	169
907954	T5B-5-SOND*/IV/SVB	170
907955	T5B-6-SOND*/IV/SVB	170
907956	T5B-7-SOND*/IV/SVB	170
907957	T5B-8-SOND*/IV/SVB	170
907968	T5B-1-SOND*/Z	169
907969	T5B-2-SOND*/Z	169
907970	T5B-3-SOND*/Z	169
907971	T5B-4-SOND*/Z	169
907972	T5B-5-SOND*/Z	170
907973	T5B-6-SOND*/Z	170
907974	T5B-7-SOND*/Z	170
907975	T5B-8-SOND*/Z	170
907976	T5B-9-SOND*/Z	170
907977	T5B-10-SOND*/Z	170
907978	T5-1-SOND*/E	171
907979	T5-2-SOND*/E	171
907980	T5-3-SOND*/E	171
907981	T5-4-SOND*/E	171
907982	T5-5-SOND*/E	172
907983	T5-6-SOND*/E	172
907984	T5-7-SOND*/E	172
907985	T5-8-SOND*/E	172
907986	T5-9-SOND*/E	172
907987	T5-9-SOND*/EA/SVB-SW	172
907988	T5-2-SOND*/EA/SVB	171
907989	T5-3-SOND*/EA/SVB	171
907990	T5-4-SOND*/EA/SVB	171
908003	T5-1-SOND*/IV/SVB	171
908004	T5-2-SOND*/IV/SVB	171
908005	T5-4-SOND*/IV/SVB	171
908007	T5-5-SOND*/IV/SVB	172
908008	T5-6-SOND*/IV/SVB	172
908009	T5-7-SOND*/IV/SVB	172
908010	T5-8-SOND*/IV/SVB	172
908021	T5-1-SOND*/Z	171
908022	T5-2-SOND*/Z	171

Article number	Part number	Page
908023	T5-3-SOND*/Z	171
908025	T5-5-SOND*/Z	172
908026	T5-6-SOND*/Z	172
908027	T5-7-SOND*/Z	172
908028	T5-8-SOND*/Z	172
908029	T5-9-SOND*/EA/SVB	172
908030	T5-9-SOND*/IV/SVB	172
908031	T5-1-SOND*/EA/SVB	171
908043	T0-1-SOND*/EA/SVB-SW	165
908044	T0-2-SOND*/EA/SVB-SW	165
908045	T0-3-SOND*/EA/SVB-SW	165
908046	T0-4-SOND*/EA/SVB-SW	165
908054	T0-1-SOND*/IV/SVB-SW	165
908055	T0-2-SOND*/IV/SVB-SW	165
908056	T0-3-SOND*/IV/SVB-SW	165
908057	T0-4-SOND*/IV/SVB-SW	165
908080	T3-5-SOND*/EA/SVB-SW	167, 168
908082	T4-1-SOND*/EA/SVB-SW	167
908085	T3-6-SOND*/EA/SVB-SW	168
908091	T3-5-SOND*/IV/SVB-SW	167, 168
908093	T4-1-SOND*/IV/SVB-SW	167
908096	T3-6-SOND*/IV/SVB-SW	168
908106	T5B-1-SOND*/EA/SVB-SW	169
908107	T5B-2-SOND*/EA/SVB-SW	169
908108	T5B-3-SOND*/EA/SVB-SW	169
908109	T5B-4-SOND*/EA/SVB-SW	169
908110	T5B-5-SOND*/EA/SVB-SW	170
908111	T5B-6-SOND*/EA/SVB-SW	170
908112	T5B-7-SOND*/EA/SVB-SW	170
908113	T5B-8-SOND*/EA/SVB-SW	170
908114	T5B-1-SOND*/IV/SVB-SW	169
908115	T5B-2-SOND*/IV/SVB-SW	169
908116	T5B-3-SOND*/IV/SVB-SW	169
908117	T5B-4-SOND*/IV/SVB-SW	169
908118	T5B-5-SOND*/IV/SVB-SW	170
908119	T5B-6-SOND*/IV/SVB-SW	170
908120	T5B-7-SOND*/IV/SVB-SW	170
908121	T5B-8-SOND*/IV/SVB-SW	170
908126	T5-1-SOND*/EA/SVB-SW	171
908127	T5-2-SOND*/EA/SVB-SW	171
908128	T5-3-SOND*/EA/SVB-SW	171
908129	T5-4-SOND*/EA/SVB-SW	171
908130	T5-5-SOND*/EA/SVB-SW	172
908131	T5-6-SOND*/EA/SVB-SW	172
908132	T5-7-SOND*/EA/SVB-SW	172
908133	T5-8-SOND*/EA/SVB-SW	172
908134	T5-1-SOND*/IV/SVB-SW	171
908135	T5-2-SOND*/IV/SVB-SW	171
908136	T5-3-SOND*/IV/SVB-SW	171
908137	T5-4-SOND*/IV/SVB-SW	171
908138	T5-5-SOND*/IV/SVB-SW	172
908139	T5-6-SOND*/IV/SVB-SW	172
908140	T5-7-SOND*/IV/SVB-SW	172
908141	T5-8-SOND*/IV/SVB-SW	172
908991	T5-5-SOND*/EA/SVB	172
908992	T5-6-SOND*/EA/SVB	172
908993	T5-7-SOND*/EA/SVB	172
908994	T5-8-SOND*/EA/SVB	172



# Index - By part number

Part number	Article number	Page
AB-CL-K4/5	206914	151, 163
BS45X14-T0	029416	156
BS84X24-P3	031789	156
CI-K1H-T0-2	105854	94, 162
CI-K1H-T0-4	105855	94, 162
CI-K1-T0-2	207435	94, 162
CI-K1-T0-4	207436	94, 162
CI-K2H-T3-2	269462	94, 162
CI-K2H-T3-4	105859	94, 162
CI-K2H-T3-5	105860	94, 162
CI-K2-T3-2	207437	94, 162
CI-K2-T3-4	225325	94, 162
CI-K2-T3-5	207438	94, 162
CI-K4-T5B-2	207439	46, 162
CI-K4-T5B-4	207440	94, 162
CI-K5-T5-2	207441	94, 162
CI-K5-T5-4	207442	94, 162
DE-P3	093972	160
DE-T0	093487	160
ES-KMS(*)-T0	231973	158
ES-KMS1-T0	231972	158
EZ/S-A	045458	67
EZ/S-A-TM	046991	67
EZ/S-B	045459	67
EZ/S-B-TM	046992	67
EZ/S-D	045461	67
EZ/S-E	045462	67
EZ/S-E-TM	046995	67
EZ/S-F	045463	67
EZ/S-F-TM	046996	67
EZ/S-G	045464	67
EZ/S-G-TM	046997	67
EZ/S-H	045465	67
EZ/S-J	045466	67
EZ/S-N	045468	67
EZ/S-R	045471	67
EZ/S-R-TM	047004	67
EZ-P1	091455	46
EZ-T0	081622	46
FORKTERM-P1	400136	159
FS(*)-P3	231895	155
FS(*)-T0	231893	155
FS908GE-P3	031475	155
FS908GE-T0	003198	155
FS-ALU980-P3	266906	155
FS-ALU980-T0	266905	155
H1-T5	045062	161
H3-T0	093828	46, 161
H111-PI/P3E	061813	45, 160
H111-PI/P3Z	062031	91, 113, 152, 160
H121-P5-125/160E	280963	45, 160
H121-P5-125/160Z	280964	92, 160
H121-P5-250/315E	280965	45, 160
H121-P5-250/315Z	280966	92, 160
H-P1	017253	161
H-P14	019626	161
H-P3	021999	161
H-P5-125/160	293977	161
H-P5-250/315	293978	161
HS-SA(*)-T0	256151	158
H-T8	200184	161
HZ-T5	045063	161
I1H	105870	151, 162
I2H	105871	151, 162
IVS/S-A	232034	113
IVS/S-B	232036	113
IVS/S-E	232040	113
IVS/S-F	232038	113
IVS/S-G	232043	113
IVS/S-R	232042	113
IVS-T0	091114	113
K1DB/P	1818029	93
K1DG/P	1818031	93
K1DR/P	1818030	93
K2SDB/C	1818038	93
K2SDB/P	1818032	93
K2SDG/C	1818040	93
K2SDG/P	1818034	93
K2SDR/C	1818039	93
K2SDR/P	1818033	93
K-CL-K1/2	207451	151, 163
K-CL-K4	206916	151, 163
K-CL-K5	218488	151, 163
KNB-P1/M	172838	93
KNB-P3	041282	154
KNB-P3/M	172839	93
KNB-RT-P3	046028	154
KNB-RT-T0	043655	154
KNB-T0	038909	154
KNK-P3	000649	92
KNK-T0	000650	92
KT-M25	207603	151
MBS-I2	290191	152
MBS-I4	118742	152
N-P1E	000651	45, 159
N-P3E	062432	45, 159
N-P1Z	000652	91, 113, 152, 159
N-P3Z	064805	91, 113, 159
N-P5-125/160E	280969	45, 159
N-P5-125/160Z	280970	91, 159
N-P5-250/315E	280971	45, 159
N-P5-250/315Z	280972	91, 159
P1/P3-M400	172844	93
P1/P3-M600	172845	93
P1-25/E	038724	18
P1-25/E/N	076845	18
P1-25/E/SA(S)	050966	21
P1-25/E/SVA(A)	050965	20
P1-25/E/SVA(S)-RT	050967	22

Part number	Article number	Page
P1-25/E/SVC(S)-RT	044974	22
P1-25/EA/SVB	041097	25
P1-25/EA/SVB/HI11	091080	27
P1-25/EA/SVB/N	081587	25
P1-25/EA/SVB/N/HI11	048367	27
P1-25/EA/SVB-SW	048365	24
P1-25/EA/SVB-SW/HI11	070194	26
P1-25/EA/SVB-SW/N	083960	24
P1-25/EA/SVB-SW/N/HI11	050740	26
P1-25/E-RT	002388	22
P1-25/EZ	041250	49
P1-25/EZ/N	079218	49
P1-25/I2	207299	116
P1-25/I2/N	207303	116
P1-25/I2/SVA(A)	207304	118
P1-25/I2/SVA(S)	207305	118
P1-25/I2/SVA(S)-RT	207306	120
P1-25/I2/SVB	207293	126
P1-25/I2/SVB/HI11	207297	132
P1-25/I2/SVB/N	207298	126
P1-25/I2/SVB-SW	207294	123
P1-25/I2/SVB-SW/HI11	207295	129
P1-25/I2/SVB-SW/N	207296	123
P1-25/I2/SVC(S)-RT	207307	120
P1-25/I2H	226898	116
P1-25/I2H/MBS/SVB	182413	127
P1-25/I2H/MBS/SVB/HI11	182415	133
P1-25/I2H/MBS/SVB-SW	182414	124
P1-25/I2H/MBS/SVB-SW/HI11	182416	130
P1-25/I2H/N	226901	116
P1-25/I2H/SVB	226900	126
P1-25/I2H/SVB/HI11	226902	129, 132
P1-25/I2H/SVB/N	227860	126
P1-25/I2H/SVB-SW	227861	123
P1-25/I2H/SVB-SW/HI11	227862	129
P1-25/I2H/SVB-SW/N	227863	123
P1-25/I2-RT	207300	120
P1-25/I2-SI	207313	144
P1-25/I2-SI/HI11	207310	144
P1-25/I2-SI/HI11-SW	207311	143
P1-25/I2-SI/N	207312	144
P1-25/I2-SI/N-SW	207313	143
P1-25/I2-SI-SW	207309	143
P1-25/IVS	052962	97
P1-25/IVS/N	083964	97
P1-25/IVS-RT	013140	99
P1-25/M4/K1-PG	172772	77
P1-25/M4/K1-PG/HI11	172781	79
P1-25/M4/K1-PG/N	172774	77
P1-25/M4/K1-PG/N/HI11	172784	79
P1-25/M4/K1-PR	172771	78
P1-25/M4/K1-PR/HI11	172775	80
P1-25/M4/K1-PR/N	172773	78
P1-25/M4/K1-PR/N/HI11	172777	80
P1-25/M4/SVB/HI11	172767	80
P1-25/M4/SVB/N	172877	78
P1-25/M4/SVB/N/HI11	172769	80
P1-25/M4/SVB-SW	172876	77
P1-25/M4/SVB-SW/HI11	172768	79
P1-25/M4/SVB-SW/N	172878	77
P1-25/M4/SVB-SW/N/HI11	172770	79
P1-25/M4/SVB-SW/N/HI11	172770	79
P1-25/SE1	197344	117
P1-25/SE1/N	197345	117
P1-25/SE1/SVB	197346	128
P1-25/SE1/SVB/HI11	197347	134
P1-25/SE1/SVB/N	197348	128
P1-25/SE1/SVB-SW	197349	125
P1-25/SE1/SVB-SW/HI11	197350	131
P1-25/SE1/SVB-SW/N	197351	125
P1-25/IVS/SVB	055335	74
P1-40/IVS/HI11	095826	76
P1-25/IVS/N	086333	74
P1-25/IVS/N/HI11	053113	76
P1-25/IVS/SVB-SW	050738	73
P1-25/IVS/SVB-SW/HI11	098199	75
P1-25/IVS/SVB-SW/N	088706	73
P1-25/XM	172834	93
P1-25/Z	057708	70
P1-25/Z/N	088710	70
P1-25/Z/SVA(A)	050969	71
P1-25-I2H/HI11	226899	121
P1-32/E	079065	18
P1-32/E/N	093456	18
P1-32/E/SA(S)	044977	21
P1-32/E/SVA(A)	050970	20
P1-32/E/SVA(S)-RT	050971	22
P1-32/E/SVC(S)-RT	044975	22
P1-32/EA/SVB	081438	25
P1-32/EA/SVB/HI11	072567	27
P1-32/EA/SVB/N	091079	25
P1-32/EA/SVB/N/HI11	057859	27
P1-32/EA/SVB-SW	053111	24
P1-32/EA/SVB-SW/HI11	012772	26
P1-32/EA/SVB-SW/N	093452	24
P1-32/EA/SVB-SW/N/HI11	060232	26
P1-32/E-RT	003197	22
P1-32/EZ	048369	49
P1-32/EZ/N	095829	49
P1-32/I2	207320	116
P1-32/I2/N	207324	116
P1-32/I2/SVA(A)	207325	118
P1-32/I2/SVA(S)	207326	118
P1-32/I2/SVB	207314	126
P1-32/I2/SVB/HI11	207318	132
P1-32/I2/SVB/N	207319	126
P1-32/I2/SVB-SW	207315	123
P1-32/I2/SVB-SW/HI11	207316	129
P1-32/I2/SVB-SW/N	207317	123

Part number	Article number	Page
P1-32/I2/SVC(S)-RT	207328	120
P1-32/I2H	227866	116
P1-32/I2H/MBS/SVB	182417	127
P1-32/I2H/MBS/SVB/HI11	182419	133
P1-32/I2H/MBS/SVB-SW	182418	124
P1-32/I2H/MBS/SVB-SW/HI11	182420	130
P1-32/I2H/N	227869	116, 123
P1-32/I2H/SVB	227868	126
P1-32/I2H/SVB/HI11	227870	132
P1-32/I2H/SVB/N	227871	126
P1-32/I2H/SVB-SW	227872	123
P1-32/I2H/SVB-SW/HI11	227873	129
P1-32/I2H/SVB-SW/N	227874	123
P1-32/I2-RT	207321	120
P1-32/I2-SI	207329	144
P1-32/I2-SI/HI11	207331	144
P1-32/I2-SI/HI11-SW	207332	143
P1-32/I2-SI/N	207333	144
P1-32/I2-SI/N-SW	207334	143
P1-32/I2-SI-SW	207330	143
P1-32/IVS	093303	97
P1-32/IVS/N	010402	97
P1-32/IVS-RT	022632	99
P1-32/M4/K1-PG	172874	77
P1-32/M4/K1-PG/HI11	172776	79
P1-32/M4/K1-PG/N	172779	77
P1-32/M4/K1-PG/N/HI11	172783	79
P1-32/M4/K1-PR	172873	78
P1-32/M4/K1-PR/HI11	172780	80
P1-32/M4/K1-PR/N	172778	78
P1-32/M4/K1-PR/N/HI11	172782	80
P1-32/M4/SVB	172865	78
P1-32/M4/SVB/HI11	172869	80
P1-32/M4/SVB/N	172867	78
P1-32/M4/SVB/N/HI11	172871	80
P1-32/M4/SVB-SW	172866	77
P1-32/M4/SVB-SW/N	172868	77
P1-32/SE1	197352	117
P1-32/SE1/N	197353	117
P1-32/SE1/SVB/HI11	197355	134
P1-32/SE1/SVB-SW	197357	125
P1-32/SE1/SVB-SW/HI11	197358	131
P1-32/SE1/SVB-SW/N	197359	125
P1-32/V/SVB	095676	74
P1-32/V/SVB/HI11	015145	76
P1-32/V/SVB/N	095825	74
P1-32/V/SVB/N/HI11	062605	76
P1-32/V/SVB-SW	055484	73
P1-32/V/SVB-SW/HI11	017518	75
P1-32/V/SVB-SW/N	098198	73
P1-32/V/SVB-SW/N/HI11	064978	75
P1-32/XM	172835	93
P1-32/Z	098049	70
P1-32/Z/N	015148	70
P1-32-I2H/HI11	227867	121
P1-40/E	198889	18
P1-40/E/N	198891	18
P1-40/EA/SVB	198894	25
P1-40/EA/SVB/HI11	198895	27
P1-40/EA/SVB/N	198896	25
P1-40/EA/SVB/N/HI11	198897	27
P1-40/EA/SVB-SW	198898	24
P1-40/EA/SVB-SW/HI11	198899	26
P1-40/EA/SVB-SW/N	199000	24
P1-40/EA/SVB-SW/N/HI11	199001	26
P1-40/E-RT	199902	22
P1-40/EZ	199903	49
P1-40/EZ/N	199904	49
P1-40/I2	199906	116
P1-40/I2/SVB	199909	126
P1-40/I2/SVB/HI11	199910	132
P1-40/I2/SVB/N	199911	126
P1-40/I2/SVB-SW	199912	123
P1-40/I2/SVB-SW/HI11	199913	129
P1-40/I2/SVB-SW/N	199914	123
P1-40/I2H	199915	116
P1-40/I2H/MBS/SVB	199917	127
P1-40/I2H/MBS/SVB/HI11	199918	133
P1-40/I2H/MBS/SVB-SW	199919	124
P1-40/I2H/MBS/SVB-SW/HI11	199920	130
P1-40/I2H/N	199921	116
P1-40/I2H/SVB	199922	126
P1-40/I2H/SVB/HI11	199923	132
P1-40/I2H/SVB/N	199924	126
P1-40/I2H/SVB-SW	199925	123
P1-40/I2H/SVB-SW/HI11	199926	129
P1-40/I2H/SVB-SW/N	199927	123
P1-40/I2-RT	199930	120
P1-40/IVS	199931	97
P1-40/IVS/N	199933	97
P1-40/IVS-RT	199935	99
P1-40/M4/SVB	199936	78
P1-40/M4/SVB/HI11	199937	80
P1-40/M4/SVB/N	199938	78
P1-40/M4/SVB/N/HI11	199939	80
P1-40/M4/SVB-SW	199940	77
P1-40/M4/SVB-SW/N	199942	77
P1-40/N	199908	116
P1-40/SE1	199944	117
P1-40/SE1/N	199945	117
P1-40/SE1/SVB/HI11	199947	134
P1-40/SE1/SVB-SW</		

# Index - By part number

Part number	Article number	Page	Part number	Article number	Page	Part number	Article number	Page
P1-40V/SVB-SW/HI11	199959	75	P3-63M4/K2-PR/N	172812	78	SVB-SW-P1/M	172842	93
P1-40V/SVB-SW/N	199961	73	P3-63M4/K2-PR/N/HI11	172816	80	SVB-SW-P3	062491	153
P1-40V/SVB-SW/N/HI11	199962	75	P3-63M4/SVB	172784	78	SVB-SW-P3/M	172843	93
P1-40/Z	199964	70	P3-63M4/SVB/HI11	172788	80	SVB-SW-T0	060285	153
P1-40/Z/N	199966	70	P3-63M4/SVB-SW	172785	77	SVB-T0	057892	153
P1-40-I2/HI11	199916	121	P3-63M4/SVB-SW/HI11	172807	79	SVC(*)-T3	907748	158
P3-100/E	067201	18	P3-63M4/SVB-SW/N/HI11	172809	79	SVC-T3	050975	158
P3-100/E/N	031759	18	P3-63/SE1/SVB/HI11	197363	134	TO-10-SOND*/E	907774	166
P3-100/EA/SVB	074320	25	P3-63/SE3	197360	117	TO-10-SOND*/EZ	907796	166
P3-100/EA/SVB/HI11	029383	27	P3-63/SE3/N	197361	117	TO-10-SOND*/IVS	907815	166
P3-100/EA/SVB/N	019890	25	P3-63/SE3/SVB	197362	128	TO-1-102/E	088709	18
P3-100/EA/SVB/N/HI11	076843	27	P3-63/SE3/SVB/N	197364	128	TO-1-102/EA/SVB	091078	25
P3-100/EA/SVB-SW	062603	24	P3-63/SE3/SVB-SW	197365	125	TO-1-102/EA/SVB-SW	093451	24
P3-100/EA/SVB-SW/HI11	031756	26	P3-63/SE3/SVB-SW/HI11	197366	131	TO-1-102/E-RT	009046	22
P3-100/EA/SVB-SW/N	022263	24	P3-63/SE3/SVB-SW/N	197367	125	TO-1-102/EZ	091082	49
P3-100/EA/SVB-SW/N/HI11	079216	26	P3-63/V/SVB	046218	74	TO-1-102/EZ/S	014933	20
P3-100/E-RT	007189	22	P3-63/V/SVB/HI11	024637	76	TO-1-102/I	207061	116
P3-100/I5	207381	116	P3-63/V/SVB/N	015144	74	TO-1-102/I1/S	207063	118
P3-100/I5/N	207385	116	P3-63/V/SVB/N/HI11	072097	76	TO-1-102/I1/SVB	207143	126
P3-100/I5/SVB	207373	126	P3-63/V/SVB-SW	060230	73	TO-1-102/I1/SVB-SW	207144	123
P3-100/I5/SVB/HI11	207378	132	P3-63/V/SVB-SW/HI11	027010	75	TO-1-102/I1-RT	207062	120
P3-100/I5/SVB/N	207379	126	P3-63/V/SVB-SW/N	017517	73	TO-1-102/IVS	015147	97
P3-100/I5/SVB/N/HI11	207380	132	P3-63/V/SVB-SW/N/HI11	074470	75	TO-1-102/IVS-RT	079583	99
P3-100/I5/SVB-SW	207374	123	P3-63/XM	172836	93	TO-1-102/SE1	197379	117
P3-100/I5/SVB-SW/HI11	207375	129	P3-63/Z	050591	70	TO-1-102/SE1/SVB	197380	128
P3-100/I5/SVB-SW/N	207376	123	P3-63/Z/N	027013	70	TO-1-102/SE1/SVB-SW	197381	125
P3-100/I5/SVB-SW/N/HI11	207377	129	P5-125/E	280897	18	TO-1-102/IVS/SVB	095824	74
P3-100/I5-RT	207382	120	P5-125/EA/SVB	280898	25	TO-1-102/IVS/SVB-SW	022330	73
P3-100/I5-SI	207386	144	P5-125/EA/SVB/HI10	280899	27	TO-1-102/Z	095828	70
P3-100/I5-SI/HI11	207388	144	P5-125/EA/SVB/N	280910	25	TO-1-102/Z/S	014971	71
P3-100/I5-SI/HI11-SW	207389	143	P5-125/EA/SVB-SW	280911	24	TO-1-15321/E	086317	21
P3-100/I5-SI/N	207390	144	P5-125/EA/SVB-SW/HI10	280912	26	TO-1-15321/EZ	088690	50
P3-100/I5-SI/N-SW	207391	143	P5-125/EA/SVB-SW/N	280913	24	TO-1-15321/I1	207064	119
P3-100/I5-SI-SW	207387	143	P5-125/V/SVB	280914	74	TO-1-15321/IVS	093436	98
P3-100/IVS	081439	97	P5-125/V/SVB/HI10	280915	76	TO-1-15321/Z	095809	71
P3-100/IVS/N	034132	97	P5-125/V/SVB/N	280916	74	TO-1-15322/E	010382	21
P3-100/IVS-RT	086185	99	P5-125/V/SVB-SW	280917	73	TO-1-15322/EZ	012755	50
P3-100/M4/K1-PG/N/HI11	172831	79	P5-125/V/SVB-SW/HI10	280918	75	TO-1-15322/I1	207065	119
P3-100/M4/K1-PG/N/HI11	172833	79	P5-125/V/SVB-SW/N	280919	73	TO-1-15322/IVS	017501	98
P3-100/M4/K2-PG	172827	77	P5-125/Z	090931	70	TO-1-15366/E	081572	21
P3-100/M4/K2-PG/N	172829	77	P5-160/E	280921	18	TO-1-15366/EZ	083945	50
P3-100/M4/K2-PR	172826	78	P5-160/EA/SVB	280922	25	TO-1-15401/E	038854	19
P3-100/M4/K2-PR/HI11	172830	80	P5-160/EA/SVB/HI10	280923	27	TO-1-15401/EZ	041227	49
P3-100/M4/K2-PR/N	172828	78	P5-160/EA/SVB/N	280924	25	TO-1-15401/I1	207067	119
P3-100/M4/K2-PR/N/HI11	172832	80	P5-160/EA/SVB-SW	280925	24	TO-1-15401/IVS	045973	97
P3-100/M4/SVB	172818	78	P5-160/EA/SVB-SW/HI10	280926	26	TO-1-15401/Z	048346	70
P3-100/M4/SVB/HI11	172822	80	P5-160/EA/SVB-SW/N	280927	24	TO-1-15402/E	053092	19
P3-100/M4/SVB/N/HI11	172824	80	P5-160/V/SVB	280928	74	TO-1-15402/EZ	055465	49
P3-100/M4/SVB-SW	172819	77	P5-160/V/SVB/HI10	280929	76	TO-1-15402/I1	207068	119
P3-100/SE1/SVB/HI11	197371	134	P5-160/V/SVB/N	280930	74	TO-1-15402/IVS	060211	97
P3-100/SE3	197368	117	P5-160/V/SVB-SW	280931	73	TO-1-15402/Z	062584	70
P3-100/SE3/N	197369	117	P5-160/V/SVB-SW/HI10	280932	75	TO-1-15421/E	095806	29
P3-100/SE3/SVB	197370	128	P5-160/V/SVB-SW/N	280933	73	TO-1-15421/EZ	098179	52
P3-100/SE3/SVB/N	197372	128	P5-160/Z	280934	70	TO-1-15421/I1	207069	135
P3-100/SE3/SVB-SW	197373	125	P5-250/E	280935	18	TO-1-15421/IVS	012752	101
P3-100/SE3/SVB-SW/HI11	197374	131	P5-250/EA/SVB	280936	25	TO-1-15421/Z	015125	81
P3-100/SE3/SVB-SW/N	197375	125	P5-250/EA/SVB/HI10	280937	27	TO-1-15431/E	019872	33
P3-100V/SVB	088558	74	P5-250/EA/SVB/N	280938	25	TO-1-15431/EZ	022245	58
P3-100V/SVB/HI11	034129	76	P5-250/EA/SVB-SW	280939	24	TO-1-15431/I1	207070	140
P3-100V/SVB/N	024636	74	P5-250/EA/SVB-SW/HI10	280940	26	TO-1-15431/IVS	026991	104
P3-100V/SVB/N/HI11	081589	76	P5-250/EA/SVB-SW/N	280941	24	TO-1-15431/SE1	197430	137
P3-100V/SVB-SW	064976	73	P5-250/V/SVB	280942	74	TO-1-15431/Z	029364	83
P3-100V/SVB-SW/HI11	036502	75	P5-250/V/SVB/HI10	280943	76	TO-1-15434/E	062586	33
P3-100V/SVB-SW/N	027009	73	P5-250/V/SVB/N	280944	74	TO-1-15434/EZ	018053	58
P3-100V/SVB-SW/N/HI11	083962	75	P5-250/V/SVB-SW	280945	73	TO-1-15434/I1	207071	140
P3-100/XM	172837	93	P5-250/V/SVB-SW/HI10	280946	75	TO-1-15434/IVS	069705	104
P3-100/Z	280920	70	P5-250/V/SVB-SW/N	280947	73	TO-1-15434/Z	072078	83
P3-100/Z/N	038878	70	P5-250/Z	280948	70	TO-1-15451/E	076824	33
P3-63/E	028661	18	P5-315 kWV/SVB	280956	74	TO-1-15451/EZ	079197	58
P3-63/E/N	019894	18	P5-315 kWV/SVB/N	280958	74	TO-1-15451/I1	207072	140
P3-63/EA/SVB	031607	25	P5-315/E	280949	18	TO-1-15451/IVS	083943	104
P3-63/EA/SVB/HI11	019891	27	P5-315/EA/SVB	280950	25	TO-1-15451/Z	086316	83
P3-63/EA/SVB/N	010398	25	P5-315/EA/SVB/HI10	280951	27	TO-1-15511/E	019875	20
P3-63/EA/SVB/N/HI11	067351	27	P5-315/EA/SVB/N	280952	25	TO-1-15511/EZ	022248	50
P3-63/EA/SVB-SW	057857	24	P5-315/EA/SVB-SW	280953	24	TO-1-15511/I1	207073	119
P3-63/EA/SVB-SW/HI11	022264	26	P5-315/EA/SVB-SW/HI10	280954	26	TO-1-15511/IVS	026994	98
P3-63/EA/SVB-SW/N	012771	24	P5-315/EA/SVB-SW/N	280955	24	TO-1-15511/Z	029367	71
P3-63/EA/SVB-SW/N/HI11	069724	26	P5-315/V/SVB/HI10	280957	76	TO-11-SOND*/E	907775	166
P3-63/E-RT	005743	22	P5-315/V/SVB-SW	280959	73	TO-11-SOND*/EZ	907797	166
P3-63/I4	207356	116	P5-315/V/SVB-SW/HI10	280960	75	TO-11-SOND*/IVS	907816	166
P3-63/I4/MBS/SVB	182421	127	P5-315/V/SVB-SW/N	280961	73	TO-11-SOND*/Z	907848	166
P3-63/I4/MBS/SVB/HI11	182423	133	PE-315/Z	280962	70	TO-11-SOND*/Z	907849	166
P3-63/I4/MBS/SVB-SW	182422	124	PE-P5-125/160E	280973	45, 159	TO-1-8200/E	067352	18
P3-63/I4/MBS/SVB-SW/HI11	182424	130	PE-P5-125/160Z	280974	91, 159	TO-1-8200/EA/SVB	053110	25
P3-63/I4/N	207360	116	PE-P5-250/315E	280975	45, 159	TO-1-8200/EA/SVB-SW	055483	24
P3-63/I4/SVB	207343	126	PE-P5-250/315Z	280976	91, 159	TO-1-8200/E-RT	009474	22
P3-63/I4/SVB/HI11	207348	132	PI-25/M4/SVB	172875	78	TO-1-8200/EZ	069725	49
P3-63/I4/SVB/N	207349	126	PI-25/V/SVB-SW/N/HI11	055486	75	TO-1-8200/I1	207074	116
P3-63/I4/SVB/N/HI11	207350	132	PI-32/M4/SVB-SW/HI11	172870	79	TO-1-8200/I1/RT	207075	120
P3-63/I4/SVB-SW	207344	123	PI-32/M4/SVB-SW/N/HI11	172872	79	TO-1-8200/I1/SVB	207145	126
P3-63/I4/SVB-SW/HI11	207345	129	PI-32/SE1/SVB	197354	128	TO-1-8200/I1/SVB-SW	207146	123
P3-63/I4/SVB-SW/N	207346	123	PI-32/SE1/SVB/N	197356	128	TO-1-8200/IVS	074471	97
P3-63/I4/SVB-SW/N/HI11	207347	129	PI-40/SE1/SVB/N	199948	128	TO-1-8200/IVS-RT	081956	99
P3-63/I4-RT	207357	120	PI-40M4/SVB-SW/HI11	199941	79	TO-1-8200/SE1	197383	117
P3-63/I4-SI	207361	144	PI-40M4/SVB-SW/N/HI11	199943	79	TO-1-8200/SE1/SVB	197384	128
P3-63/I4-SI/HI11	207363	144	PI-40/SE1/SVB	199946	128	TO-1-8200/SE1/SVB-SW	197385	125
P3-63/I4-SI/HI11-SW	207364	143	PI-40/XM	199888	93	TO-1-8200/V/SVB	057856	74
P3-63/I4-SI/N	207365	144	S(*)-SOND-SA(*)-T0	231965	157	TO-1-8200/V/SVB-SW	060229	73
P3-63/I4-SI/N-SW	207366	143	S(*)-T0	231959	157	TO-1-8200/Z	076844	70
P3-63/I4-SI-SW	207362	143	S-SOND-KMS(*)-T0	231957	157	TO-1-8210/E	012742	29
P3-63/IVS	041099	97	S-T0	086709	157	TO-1-8210/EZ	048337	52
P3-63/IVS/N	022267	97	ST-P5-250/314	280978	162	TO-1-8210/I1	207076	135
P3-63/IVS-RT	045845	99	SVA(*)-SOND-SA(*)-T3	231971	157	TO-1-8210/IVS	074440	101
P3-63/M4/K1-PG/N/HI11	172815	79	SVA(*)-T3	907745	157	TO-1-8210/SE1	197386	137
P3-63/M4/K1-PG/N/HI11	172817	79	SVA-SOND-KMS(*)-T3	231967	157	TO-1-8210/Z	019862	81
P3-63/M4/K2-PG	172811	77	SVA-T3	050974	157	TO-1-8214/E	019863	30
P3-63/M4/K2-PG/N	172813	77	SVB-P1/M	172840	93	TO-1-8214/EZ	076815	52
P3-63/M4/K2-PR	172810	78	SVB-P3	052999	153	TO-1-8214/I1	207077	136
P3-63/M4/K2-PR/HI11	172814	80	SVB-P3/M	172841	93	TO-1-8214/IVS	045967	101



# Index - By part number

Part number	Article number	Page	Part number	Article number	Page	Part number	Article number	Page
TO-1-8214/SE1	197390	137	TO-2-15679V/SVB-SW	088707	75	TO-3-15423/EZ	036482	52
TO-1-8214/Z	050720	82	TO-2-15679/Z	041252	72	TO-3-15423/I1	207114	135
TO-1-8220/E	031728	31, 42	TO-2-15683/E	016619	23	TO-3-15423/IVS	041228	101
TO-1-8220/EZ	095799	54, 65	TO-2-15683/EZ	016658	51	TO-3-15423/Z	043601	81
TO-1-8220/I1	207078	136, 148	TO-2-15907/E	066931	33	TO-3-15433/E	048348	33
TO-1-8220/IVS	055459	102, 110	TO-2-15907/EZ	069304	58	TO-3-15433/EZ	050721	58
TO-1-8220/SE1	197393	138	TO-2-15907/I1	207095	140	TO-3-15433/I1	207115	140
TO-1-8220/Z	086312	82, 89	TO-2-15907/IVS	076423	104	TO-3-15433/IVS	055467	104
TO-1-8240/E	034105	41	TO-2-15907/Z	078796	87	TO-3-15433/SE1	197432	137
TO-1-8240/EZ	043597	64	TO-2-15920/E	038861	33	TO-3-15433/Z	057840	83
TO-1-8240/I1	207079	148	TO-2-15920/EZ	041234	62	TO-3-15453/E	015127	33
TO-1-8240/IVS	027076	109	TO-2-15920/IVS	029452	107	TO-3-15453/EZ	017500	58
TO-1-8240/Z	060208	88	TO-2-15920/Z	048353	86	TO-3-15453/I1	207116	140
TO-1-91/E	072082	43	TO-2-15921/E	067337	37	TO-3-15453/IVS	022246	104
TO-1-91/EZ	074455	67	TO-2-15921/EZ	069710	62	TO-3-15453/Z	024619	83
TO-1-91/I1	207080	149	TO-2-15921/IVS	074456	107	TO-3-15513/E	048351	20
TO-1-91/IVS	079201	111	TO-2-15921/Z	076829	86	TO-3-15513/EZ	050724	50
TO-1-SOND*/E	907765	165	TO-2-15922/E	053099	37	TO-3-15513/I1	207117	119
TO-1-SOND*/EA/SVB	907776	165	TO-2-15922/EZ	055472	62	TO-3-15680/EA/SVB	038875	27
TO-1-SOND*/EA/SVB-SW	908043	165	TO-2-15922/IVS	060218	107	TO-3-15680/EA/SVB-SW	041248	26
TO-1-SOND*/EZ	907787	165	TO-2-15922/Z	062591	86	TO-3-15680/I1/SVB	207153	132
TO-1-SOND*/I1	207480	165	TO-2-8177/E	015130	20	TO-3-15680/I1/SVB-SW	207154	129
TO-1-SOND*/I1/SVB	207481	165	TO-2-8177/EZ	017503	50	TO-3-15680/I2H/MBS/SVB	182431	133
TO-1-SOND*/I1/SVB-SW	207482	165	TO-2-8177/I1	207101	119	TO-3-15680/I2H/MBS/SVB-SW	182432	130
TO-1-SOND*/IVS	907806	165	TO-2-8177/IVS	022249	98	TO-3-15680/SE1	197443	122
TO-1-SOND*/V/SVB	907817	165	TO-2-8177/Z	024622	71	TO-3-15680/SE1/IVS	197444	134
TO-1-SOND*/V/SVB-SW	908054	165	TO-2-8211/E	022234	29	TO-3-15680/SE1/SVB-SW	197445	131
TO-1-SOND*/Z	907839	165	TO-2-8211/EZ	053083	52	TO-3-15680/V/SVB	043621	76
TO-2-1/E	024639	18	TO-2-8211/I1	207102	135	TO-3-15680/V/SVB-SW	045994	75
TO-2-1/E(SVA(A))	050976	20	TO-2-8211/IVS	076813	101	TO-3-15683/EA/SVB	015571	27
TO-2-1/E(SVA(S))	050977	21	TO-2-8211/SE1	197387	137	TO-3-15683/EA/SVB-SW	015600	26
TO-2-1/E(SVA(S)-RT)	228291	22	TO-2-8211/Z	029354	81	TO-3-15683/I1	207118	121
TO-2-1/E(SVC(S)-RT)	044973	22	TO-2-8215/E	022236	30	TO-3-15683/I1/SVB	207157	132
TO-2-1/EA/SVB	038873	25	TO-2-8215/EZ	081561	52	TO-3-15683/I1/SVB-SW	207158	129
TO-2-1/EA/SVB-SW	041246	24	TO-2-8215/IVS	207103	136	TO-3-15683/I2H/MBS/SVB	182433	133
TO-2-1/E-RT	011082	22	TO-2-8215/IVS	048340	101	TO-3-15683/I2H/MBS/SVB-SW	182434	130
TO-2-1/EZ	027012	49	TO-2-8215/SE1	197391	137	TO-3-15683/IVS	016722	100
TO-2-1/I1	207081	116	TO-2-8221/E	038847	31	TO-3-15683/SE1	197449	122
TO-2-1/I1(SVA(A))	207083	118	TO-2-8221/EZ	010372	54	TO-3-15683/SE1/IVS	197450	134
TO-2-1/I1(SVA(S))	207084	118	TO-2-8221/I1	207104	136	TO-3-15683/SE1/SVB-SW	197451	131
TO-2-1/I1(SVA(S)-RT)	207085	120	TO-2-8221/IVS	057832	102	TO-3-15683/V/SVB	015634	76
TO-2-1/I1/SVB	207147	126	TO-2-8221/SE1	197394	138	TO-3-15683/V/SVB-SW	015664	75
TO-2-1/I1/SVB-SW	207148	123	TO-2-8221/Z	074450	82	TO-3-15924/E	019878	37
TO-2-1/I1(SVC(S)-RT)	207086	120	TO-2-8230/E	086865	42	TO-3-15924/EZ	022251	62
TO-2-1/I1-RT	207082	120	TO-2-8230/EZ	091058	54, 65	TO-3-15924/I1	207119	146
TO-2-1/I2H/MBS/SVB	182425	127	TO-2-8230/I1	207105	148	TO-3-15924/IVS	026997	107
TO-2-1/I2H/MBS/SVB-SW	182426	124	TO-2-8230/IVS	095804	110	TO-3-15924/Z	029370	86
TO-2-1/IVS	031758	97	TO-2-8230/Z	088177	89	TO-3-8007/E	095813	37
TO-2-1/IVS-RT	084329	99	TO-2-8231/E	012750	42	TO-3-8007/EZ	098186	62
TO-2-1/SE1	197376	117	TO-2-8231/EZ	015123	65	TO-3-8007/I1	207120	146
TO-2-1/SE1/SVB	197377	128	TO-2-8231/I1	207106	148	TO-3-8007/IVS	012759	107
TO-2-1/SE1/SVB-SW	197378	125	TO-2-8231/IVS	019869	110	TO-3-8007/Z	015132	86
TO-2-1/V/SVB	043619	74	TO-2-8231/Z	022242	89	TO-3-8048/E	034116	37
TO-2-1/V/SVB-SW	045992	73	TO-2-8241/E	050716	41	TO-3-8212/E	029353	29
TO-2-1/Z	036504	70	TO-2-8241/EZ	053089	64	TO-3-8212/EZ	057829	52
TO-2-1/Z(SVA(A))	050978	71	TO-2-8241/I1	207107	148	TO-3-8212/I1	207123	135
TO-2-15323/E	024620	21	TO-2-8241/IVS	057835	109	TO-3-8212/IVS	079186	101
TO-2-15323/EZ	026993	50	TO-2-8241/Z	062581	88	TO-3-8212/SE1	197388	137
TO-2-15323/I1	207087	119	TO-2-8242/E	067327	41	TO-3-8212/Z	036473	81
TO-2-15323/IVS	031739	98	TO-2-8242/EZ	069700	64	TO-3-8216/E	024609	30
TO-2-1540/IVS	088687	97	TO-2-8242/I1	207108	148	TO-3-8216/EZ	086307	52
TO-2-15403/E	067330	19	TO-2-8242/IVS	074446	109	TO-3-8216/I1	207434	136
TO-2-15403/EZ	069703	49	TO-2-8242/Z	076819	88	TO-3-8216/IVS	050713	101
TO-2-15403/I1	207088	116	TO-2-8400/E	053079	35	TO-3-8216/SE1	197392	137
TO-2-15403/IVS	074449	97	TO-2-8400/EZ	055452	60	TO-3-8216/Z	055466	82
TO-2-15403/Z	076822	70	TO-2-8400/I1	207111	142	TO-3-8222/E	048339	31, 42
TO-2-15404/E	081568	19	TO-2-8400/IVS	060198	106	TO-3-8222/EZ	015118	54, 65
TO-2-15404/EZ	083941	49	TO-2-8400/Z	082571	85	TO-3-8222/I1	207124	136, 148
TO-2-15404/I1	207089	116	TO-2-8900/E	207398	18	TO-3-8222/IVS	060205	102, 110
TO-2-15404/Z	091060	70	TO-2-8900/EA/SVB	207400	25	TO-3-8222/SE1	197395	138
TO-2-1540-H	207098	116	TO-2-8900/EA/SVB-SW	207401	24	TO-3-8222/Z	088686	82
TO-2-15422/E	019871	29	TO-2-8900/E-RT	207399	22	TO-3-8223/SE2	197396	138
TO-2-15422/EZ	022244	52	TO-2-8900/EZ	207402	49	TO-3-8228/E	015112	35
TO-2-15422/I1	207090	135	TO-2-8900/I1	207109	116	TO-3-8228/EZ	048334	60
TO-2-15422/IVS	026990	101	TO-2-8900/IVS	207151	126	TO-3-8228/I1	207125	142
TO-2-15422/Z	029363	81	TO-2-8900/I1/SVB	207152	123	TO-3-8228/IVS	062572	106
TO-2-15432/E	034110	33	TO-2-8900/I1/SVB-SW	207110	120	TO-3-8228/Z	074437	85
TO-2-15432/EZ	036483	58	TO-2-8900/I1-RT	207110	120	TO-3-8232/E	026988	42
TO-2-15432/I1	207091	140	TO-2-8900/I2H/MBS/SVB	182427	127	TO-3-8232/EZ	029361	65
TO-2-15432/IVS	041229	104	TO-2-8900/I2H/MBS/SVB-SW	182428	124	TO-3-8232/I1	207126	148
TO-2-15432/SE1	197431	137	TO-2-8900/IVS	207403	97	TO-3-8232/IVS	034107	110
TO-2-15432/Z	043602	83	TO-2-8900/IVS-RT	207404	99	TO-3-8232/Z	036480	89
TO-2-15435/E	003191	33	TO-2-8900/SE1	197420	117	TO-3-8233/E	041226	42
TO-2-15435/EZ	003192	58	TO-2-8900/SE1/IVS	197421	125	TO-3-8233/EZ	043599	65
TO-2-15435/I1	218971	140	TO-2-8900/SE1/SVB-SW	197422	125	TO-3-8233/I1	207127	148
TO-2-15435/IVS	003195	104	TO-2-8900/V/SVB	207405	74	TO-3-8233/IVS	048345	110
TO-2-15435/Z	003196	83	TO-2-8900/V/SVB-SW	207406	73	TO-3-8233/Z	050718	89
TO-2-15452/E	091062	33	TO-2-8900/Z	207407	70	TO-3-8243/E	081565	41
TO-2-15452/EZ	093435	58	TO-2-8901/E	231938	23	TO-3-8243/EZ	083938	64
TO-2-15452/I1	207092	140	TO-2-SOND*/E	907766	165	TO-3-8243/I1	207128	148
TO-2-15452/IVS	098181	104	TO-2-SOND*/EA/SVB	907777	165	TO-3-8243/IVS	088684	109
TO-2-15452/Z	010381	83	TO-2-SOND*/EA/SVB-SW	908044	165	TO-3-8243/Z	091057	88
TO-2-15512/E	034113	20	TO-2-SOND*/EZ	907788	165	TO-3-8244/E	095803	41
TO-2-15512/EZ	036486	50	TO-2-SOND*/I1	207483	165	TO-3-8244/EZ	098176	64
TO-2-15512/I1	207093	119	TO-2-SOND*/I1/SVB	207484	165	TO-3-8244/I1	207129	148
TO-2-15512/Z	043605	71	TO-2-SOND*/I1/SVB-SW	207485	165	TO-3-8244/IVS	012749	109
TO-2-15679/E	029387	23	TO-2-SOND*/IVS	907807	165	TO-3-8244/Z	015122	88
TO-2-15679/EA/SVB	081588	27	TO-2-SOND*/V/SVB	907818	165	TO-3-8251/EZ	013972	65
TO-2-15679/EA/SVB-SW	083961	26	TO-2-SOND*/V/SVB-SW	908055	165	TO-3-8251/IVS	013974	110
TO-2-15679/EZ	031760	51	TO-2-SOND*/Z	907840	165	TO-3-8251/Z	013976	89
TO-2-15679/I1	207094	121	TO-3-15391/E	029365	44	TO-3-8280/E	034106	41
TO-2-15679/IVS	207149	132	TO-3-15391/EZ	031738	56	TO-3-8280/EZ	036479	64
TO-2-15679/I1/SVB-SW	207150	129	TO-3-15391/I1	207112	150	TO-3-8280/I1	207130	148
TO-2-15679/I2H/MBS/SVB	182429	133	TO-3-15391/IVS	036484	112	TO-3-8280/IVS	041225	109
TO-2-15679/I2H/MBS/SVB-SW	182430	130	TO-3-15394/E	072079	44	TO-3-8280/Z	043598	88
TO-2-15679/IVS	036506	100	TO-3-15394/EZ	074452	56	TO-3-8342/E	043624	18
TO-2-15679/SE1	197440	122	TO-3-15394/I1	207113	150	TO-3-8342/EA/SVB	029382	25
TO-2-15679/SE1/IVS	197441	134	TO-3-15394/IVS	079198	112	TO-3-8342/EA/SVB-SW	031755	24
TO-2-15679/SE1/SVB-SW	197442	131	TO-3-15394/Z	081571	90	TO-3-8342/EZ	045997	49
TO-2-15679/V/SVB	086334	76	TO-3-15423/E	034109	29			

# Index - By part number

Part number	Article number	Page	Part number	Article number	Page	Part number	Article number	Page
T0-3-8342/1	207131	116	T0-4-SOND*/11	207489	165	T3-2-8400/EZ	000687	60
T0-3-8342/1/SVB	207159	126	T0-4-SOND*/11/SVB	207490	165	T3-2-8400/I2	207181	142
T0-3-8342/1/SVB-SW	207160	123	T0-4-SOND*/11/SVB-SW	207491	165	T3-2-8400/Z	095600	85
T0-3-8342/IVS	050743	97	T0-4-SOND*/IVS	907809	165	T3-2-8901/E	213949	23
T0-3-8342/SE1	197408	117	T0-4-SOND*/IV/SVB	907820	165	T3-3-15680/EA/SVB	012002	27
T0-3-8342/SE1/SVB-SW	197410	125	T0-4-SOND*/IV/SVB-SW	908057	165	T3-3-15680/EA/SVB-SW	014375	26
T0-3-8342/V/SVB	034128	74	T0-4-SOND*/Z	907842	165	T3-3-15680/EA/SVB-SW	231946	26
T0-3-8342/V/SVB-SW	036501	73	T0-5-15876/E	000893	36	T3-3-15680/I2/SVB	207202	132
T0-3-8342/Z	055489	70	T0-5-15876/EZ	000900	60	T3-3-15680/I2/SVB-SW	207203	129
T0-3-8342-SE1/SVB	197409	128	T0-5-15876/IVS	000902	106	T3-3-15680/V/SVB	016748	76
T0-3-8401/E	091047	35	T0-5-15876/Z	000942	85	T3-3-15680/V/SVB-SW	019121	75
T0-3-8401/EZ	093420	60	T0-5-8270/E	091059	42	T3-3-15683/EA/SVB	040478	27
T0-3-8401/I1	207132	142	T0-5-8270/EZ	093432	65	T3-3-15683/EA/SVB-SW	042851	26
T0-3-8401/IVS	098166	106	T0-5-8270/IVS	098178	110	T3-3-15683/I2	207182	121
T0-3-8401/Z	010366	85	T0-5-8270/Z	010378	89	T3-3-15683/I2/SVB	207206	132
T0-3-8451/E	038849	34	T0-5-8281/E	048344	41	T3-3-15683/I2/SVB-SW	207207	129
T0-3-8451/EZ	083936	59	T0-5-8281/EZ	050717	64	T3-3-15683/SE2	197475	122
T0-3-8451/I1	207133	141	T0-5-8281/IVS	055463	109	T3-3-15683/SE2/SVB	197476	134
T0-3-8451/IVS	026985	105	T0-5-8281/Z	057836	88	T3-3-15683/SE2/SVB-SW	197477	131
T0-3-8451/Z	043596	84	T0-5-8369/E	060204	31	T3-3-15683/V/SVB	045224	76
T0-3-8901/EA/SVB	231932	27	T0-5-8369/EZ	024610	54	T3-3-8212/E	068956	29
T0-3-8901/EA/SVB-SW	231933	26	T0-5-8369/IVS	064951	102	T3-3-8212/EZ	003080	52
T0-3-8901/EZ	231939	51	T0-5-SOND*/E	907769	166	T3-3-8212/I2	207183	135
T0-3-8901/I1	231941	121	T0-5-SOND*/EZ	907791	166	T3-3-8212/Z	071329	81
T0-3-8901/I1/SVB	231934	132	T0-5-SOND*/IVS	907810	166	T3-3-8216/E	023870	30
T0-3-8901/I1/SVB-SW	231935	129	T0-5-SOND*/Z	907843	166	T3-3-8216/I2	207184	136
T0-3-8901/IVS	231940	100	T0-6-15866/E	055460	36	T3-3-8222/E	052346	31
T0-3-SOND*/E	907767	165	T0-6-15866/EZ	012747	60	T3-3-8222/EZ	001069	99
T0-3-SOND*/EA/SVB	907778	165	T0-6-15866/IVS	036477	106	T3-3-8222/I2	207185	136
T0-3-SOND*/EA/SVB-SW	908045	165	T0-6-15866/Z	067326	85	T3-3-8222/Z	057092	82
T0-3-SOND*/EZ	907789	165	T0-6-8271/E	015124	42	T3-3-8228/E	002538	35
T0-3-SOND*/I1	207486	165	T0-6-8271/EZ	017497	65	T3-3-8228/EZ	000695	60
T0-3-SOND*/I1/SVB	207487	165	T0-6-8271/IVS	022243	110	T3-3-8228/I2	207186	142
T0-3-SOND*/I1/SVB-SW	207488	165	T0-6-8271/Z	024616	89	T3-3-8228/Z	004911	85
T0-3-SOND*/IVS	907808	165	T0-6-8282/E	062582	41	T3-3-8342/E	045225	18
T0-3-SOND*/IV/SVB	907819	165	T0-6-8282/EZ	064955	64	T3-3-8342/EA/SVB	071326	25
T0-3-SOND*/IV/SVB-SW	908056	165	T0-6-8282/IVS	069701	109	T3-3-8342/EA/SVB-SW	073699	24
T0-3-SOND*/Z	907841	165	T0-6-8282/Z	072074	88	T3-3-8342/I2	207187	116
T0-4-15602/E	029368	32	T0-6-8370/E	062577	31	T3-3-8342/I2/SVB	207208	126
T0-4-15602/EZ	031741	55	T0-6-8370/EZ	029356	54	T3-3-8342/I2/SVB-SW	207209	123
T0-4-15602/I1	207134	139	T0-6-8370/IVS	067324	102	T3-3-8342/SE1	197456	117
T0-4-15602/IVS	038487	103	T0-6-8370/Z	010380	82	T3-3-8342/SE1/SVB-SW	197458	125
T0-4-15682/E	010405	23	T0-6-SOND*/E	907770	166	T3-3-8342/SE2/SVB	197457	128
T0-4-15682/EA/SVB	019892	27	T0-6-SOND*/EZ	907792	166	T3-3-8342/V/SVB	076072	74
T0-4-15682/EA/SVB-SW	022265	26	T0-6-SOND*/IVS	907811	166	T3-3-8342/V/SVB-SW	078445	73
T0-4-15682/EZ	012778	51	T0-6-SOND*/Z	907844	166	T3-3-8342/Z	052344	70
T0-4-15682/I1	207135	121	T0-7-SOND*/E	907771	166	T3-3-8401/E	030992	35
T0-4-15682/I1/SVB	207161	132	T0-7-SOND*/EZ	907793	166	T3-3-8401/EZ	000694	60
T0-4-15682/I1/SVB-SW	207162	129	T0-7-SOND*/IVS	907812	166	T3-3-8401/I2	207188	142
T0-4-15682/I2/MBS/SVB	182435	133	T0-7-SOND*/Z	907845	166	T3-3-8401/Z	035739	85
T0-4-15682/I2/MBS/SVB-SW	182436	130	T0-8-8372/E	064950	31	T3-3-8451/E	028641	34
T0-4-15682/IVS	017524	100	T0-8-8372/EZ	034102	54	T3-3-8451/EZ	000956	59
T0-4-15682/SE2	197446	122	T0-8-8372/IVS	069697	102	T3-3-8451/I2	207189	141
T0-4-15682/SE2/SVB	197447	134	T0-8-8372/Z	012753	82	T3-3-8451/Z	031014	84
T0-4-15682/SE2/SVB-SW	197448	131	T0-8-SOND*/E	907772	166	T3-3-8901/EA/SVB	231945	27
T0-4-15682/V/SVB	024638	76	T0-8-SOND*/EZ	907794	166	T3-3-8901/EZ	231950	51
T0-4-15682/V/SVB-SW	027011	75	T0-8-SOND*/IVS	907813	166	T3-3-8901/I2	231951	121
T0-4-15682/Z	022270	72	T0-8-SOND*/Z	907846	166	T3-3-8901/I2/SVB	218987	132
T0-4-74949GB/E	400000	35	T0-8-SOND*/E	907773	166	T3-3-8901/I2/SVB-SW	218988	129
T0-4-8213/E	031726	29	T0-9-SOND*/EZ	907795	166	T3-3-8901/Z	231952	72
T0-4-8213/EZ	062575	52	T0-9-SOND*/IVS	907814	166	T3-4-15682/E	023869	23
T0-4-8213/I1	207136	135	T0-9-SOND*/Z	907847	166	T3-4-15682/EA/SVB	054716	27
T0-4-8213/IVS	081559	101	T3-10-SOND*/E	907859	168	T3-4-15682/EA/SVB-SW	057089	26
T0-4-8213/SE2	197389	137	T3-10-SOND*/EZ	907881	168	T3-4-15682/I2	207190	121
T0-4-8213/Z	043592	81	T3-10-SOND*/Z	907922	168	T3-4-15682/I2/SVB	207210	132
T0-4-8223/E	050712	31	T3-1-102/E	076073	18	T3-4-15682/I2/SVB-SW	207211	129
T0-4-8223/EZ	019864	54	T3-1-102/EA/SVB	014374	25	T3-4-15682/SE2	197472	122
T0-4-8223/I1	207137	136	T3-1-102/EA/SVB-SW	016747	24	T3-4-15682/SE2/SVB-SW	197474	131
T0-4-8223/IVS	062578	102	T3-1-102/E-RT	016318	22	T3-4-15682/SE2-SVB	197473	134
T0-4-8223/Z	086315	82	T3-1-102/EZ	078446	49	T3-4-15682/V/SVB	059462	76
T0-4-8251/E	013971	42	T3-1-102/I2	207165	116	T3-4-15682/V/SVB-SW	061835	75
T0-4-8251/I1	218984	148	T3-1-102/I2/SVB	207198	126	T3-4-15682/Z	030998	72
T0-4-8294/E	010371	29	T3-1-102/I2/SVB-SW	207199	123	T3-4-74949GB/E	400001	35
T0-4-8294/EZ	072069	52	T3-1-102/I2-RT	207166	120	T3-4-8213/E	076075	29
T0-4-8294/I1	207138	135	T3-1-102/IVS	019120	74	T3-4-8213/EZ	003079	52
T0-4-8294/IVS	043594	101	T3-1-102/V/SVB-SW	021493	73	T3-4-8213/I2	207191	135
T0-4-8344/E	014000	18	T3-1-102/Z	083192	70	T3-4-8213/Z	078448	81
T0-4-8344/EA/SVB	008267	25	T3-11-SOND*/E	907860	168	T3-4-8223/E	059465	31
T0-4-8344/EA/SVB-SW	008268	24	T3-11-SOND*/EZ	907882	168	T3-4-8223/I2	207192	136
T0-4-8344/EZ	014002	49	T3-11-SOND*/Z	907923	168	T3-4-8223/Z	061838	82
T0-4-8344/I1	207139	116	T3-1-8200/E	064208	116	T3-4-8294/E	002513	29
T0-4-8344/I1/SVB	207163	126	T3-1-8200/EA/SVB	066576	25	T3-4-8294/I2	207193	135
T0-4-8344/I1/SVB-SW	207164	123	T3-1-8200/EA/SVB-SW	068949	24	T3-4-8294/Z	004886	81
T0-4-8344/IVS	014006	97	T3-1-8200/E-RT	017025	22	T3-4-8344/E	020593	18
T0-4-8344/SE2	197411	117	T3-1-8200/EZ	066581	49	T3-4-8344/EA/SVB	008964	25
T0-4-8344/SE2/SVB	197412	128	T3-1-8200/I2	207167	116	T3-4-8344/EA/SVB-SW	008965	24
T0-4-8344/SE2/SVB-SW	197413	125	T3-1-8200/I2/SVB	207200	126	T3-4-8344/EZ	020595	49
T0-4-8344/V/SVB	014007	74	T3-1-8200/I2/SVB-SW	207201	123	T3-4-8344/I2	207194	116
T0-4-8344/V/SVB-SW	088272	73	T3-1-8200/IVS	007255	74	T3-4-8344/I2/SVB	207212	126
T0-4-8344/Z	014009	70	T3-1-8200/V/SVB-SW	004882	73	T3-4-8344/I2/SVB-SW	207213	123
T0-4-8410/E	024604	38	T3-1-8200/Z	071327	70	T3-4-8344/SE2	197459	117
T0-4-8410/EZ	053080	61	T3-1-8210/E	054718	29	T3-4-8344/SE2/SVB	197460	128
T0-4-8410/I1	207140	147	T3-1-8210/EZ	003072	52	T3-4-8344/SE2/SVB-SW	197461	125
T0-4-8410/IVS	064945	108	T3-1-8210/I2	207169	135	T3-4-8344/V/SVB	020598	74
T0-4-8410/Z	083929	87	T3-1-8210/Z	057091	81	T3-4-8344/V/SVB-SW	008967	73
T0-4-8440/E	041222	34	T3-1-8214/E	009632	30	T3-4-8344/Z	020600	70
T0-4-8440/EZ	086862	59	T3-1-SOND*/E	907852	167	T3-4-8410/E	009657	38
T0-4-8440/I1	207141	141	T3-2-15683/E	014377	23	T3-4-8410/EZ	000721	61
T0-4-8440/IVS	029358	105	T3-2-8211/E	061837	29	T3-4-8410/I2	207195	147
T0-4-8440/Z	048342	84	T3-2-8211/EZ	003075	52	T3-4-8410/Z	012030	87
T0-4-8441/E	043595	34	T3-2-8211/I2	207178	135	T3-4-8440/E	035760	34
T0-4-8441/EZ	093428	59	T3-2-8211/Z	064210	81	T3-4-8440/EZ	000959	59
T0-4-8441/I1	207142	141	T3-2-8215/E	016751	30	T3-4-8440/I2	207196	141
T0-4-8441/IVS	031731	105	T3-2-8215/I2	207179	136	T3-4-8440/Z	038133	84
T0-4-8441/Z	053088	84	T3-2-8221/E	045227	31	T3-4-8441/E	042879	34
T0-4-SOND*/E	907768	165	T3-2-8221/EZ	001025	54	T3-4-8441/I2	207197	141
T0-4-SOND*/EA/SVB	907779	165	T3-2-8221/I2	207180	136	T3-4-8441/Z	045252	84
T0-4-SOND*/EA/SVB-SW	908046	165	T3-2-8221/Z	047600	82	T3-4-8902/E	215222	29
T0-4-SOND*/EZ	907790	165	T3-2-8400/E	073695	35	T3-4-8902/EZ	215223	52

# Index - By part number

Part number	Article number	Page	Part number	Article number	Page	Part number	Article number	Page
T3-4-8902/I2	215224	135	T5-4-8294/E	095986	29	T5B-3-8342/E	092310	18
T3-4-8902/Z	215225	81	T5-4-8294/I5	207433	135	T5B-3-8342/EA/SVB	092308	25
T3-5-15876/E	016776	36	T5-4-8294/Z	095984	81	T5B-3-8342/EA/SVB-SW	092307	24
T3-5-15876/EZ	000797	60	T5-4-8344/EA/SVB	095961	25	T5B-3-8342/I4	207226	116
T3-5-15876/I2	207537	142	T5-4-8344/EA/SVB-SW	095960	24	T5B-3-8342/I4/SVB	207242	126
T3-5-15876/Z	019149	85	T5-4-8344/I5/SVB	207283	126	T5B-3-8342/I4/SVB-SW	207243	123
T3-5-8369/E	066584	31	T5-4-8344/I5/SVB-SW	207284	123	T5B-3-8342/I4-SI	207250	144
T3-5-8369/I2	207536	136	T5-4-8344/I/SVB	095959	74	T5B-3-8342/I4-SI-SW	207251	143
T3-5-8369/Z	088957	82	T5-4-8344/I/SVB-SW	095958	73	T5B-3-8342/I/SVB	092300	74
T3-5-SOND*/E	907850	167, 168	T5-4-8902/E	207418	29	T5B-3-8342/I/SVB-SW	092299	73
T3-5-SOND*/EA/SVB	907861	167, 168	T5-4-8902/I5	207214	135	T5B-3-8342/Z	092297	70
T3-5-SOND*/EA/SVB-SW	908080	167, 168	T5-4-8902/Z	207419	81	T5B-3-8344/E	092064	18
T3-5-SOND*/EZ	907872	167, 168	T5-4-8903/I5-SI	207289	144	T5B-3-8344/I4	207233	116
T3-5-SOND*/I2	207492	167, 168	T5-4-8903/I5-SI-SW	207290	143	T5B-3-8401/E	092296	35
T3-5-SOND*/I2/SVB	207493	167, 168	T5-4-SOND*/E	907981	171	T5B-3-8401/I4	207227	142
T3-5-SOND*/I2/SVB-SW	207494	167, 168	T5-4-SOND*/EA/SVB	907990	171	T5B-3-8401/Z	092293	85
T3-5-SOND*/I/SVB	907891	167, 168	T5-4-SOND*/EA/SVB-SW	908129	171	T5B-3-8451/E	092288	34
T3-5-SOND*/I/SVB-SW	908091	167, 168	T5-4-SOND*/I4	207533	171	T5B-3-8451/I4	207228	141
T3-5-SOND*/Z	907913	167, 168	T5-4-SOND*/I4/SVB	207534	171	T5B-3-8901/EA/SVB	207420	27
T3-6-15866/E	054744	36	T5-4-SOND*/I4/SVB-SW	207535	171	T5B-3-8901/EA/SVB-SW	207421	26
T3-6-15866/Z	057117	85	T5-4-SOND*/I/SVB	908005	171	T5B-3-8901/I4/SVB	207244	132
T3-6-8370/E	073703	31	T5-4-SOND*/I/SVB-SW	908137	171	T5B-3-8901/I4/SVB-SW	207245	129
T3-6-8370/EZ	004506	54	T5-5-SOND*/E	907982	172	T5B-3-8901/I/SVB	207422	76
T3-6-SOND*/E	907855	168	T5-5-SOND*/EA/SVB	908991	172	T5B-3-8901/I/SVB-SW	207423	75
T3-6-SOND*/EA/SVB	907866	168	T5-5-SOND*/EA/SVB-SW	908130	172	T5B-3-SOND*/E	907926	169
T3-6-SOND*/EA/SVB-SW	908085	168	T5-5-SOND*/I/SVB	908007	172	T5B-3-SOND*/EA/SVB	907936	169
T3-6-SOND*/EZ	907877	168	T5-5-SOND*/I/SVB-SW	908138	172	T5B-3-SOND*/EA/SVB-SW	908108	169
T3-6-SOND*/I/SVB	907896	168	T5-5-SOND*/Z	908025	172	T5B-3-SOND*/I4	207518	169
T3-6-SOND*/I/SVB-SW	908096	168	T5-6-SOND*/E	907983	172	T5B-3-SOND*/I4/SVB	207519	169
T3-6-SOND*/Z	907918	168	T5-6-SOND*/EA/SVB	908992	172	T5B-3-SOND*/I4/SVB-SW	207520	169
T3-7-SOND*/E	907856	168	T5-6-SOND*/EA/SVB-SW	908131	172	T5B-3-SOND*/I/SVB	907952	169
T3-7-SOND*/EZ	907878	168	T5-6-SOND*/I/SVB	908008	172	T5B-3-SOND*/I/SVB-SW	908116	169
T3-7-SOND*/Z	907919	168	T5-6-SOND*/I/SVB-SW	908139	172	T5B-3-SOND*/Z	907970	169
T3-8-8372/E	080822	31	T5-6-SOND*/Z	908026	172	T5B-4-15682/E	207424	23
T3-8-8372/Z	083195	82	T5-7-SOND*/E	907984	172	T5B-4-15682/EA/SVB	207425	27
T3-8-SOND*/E	907857	168	T5-7-SOND*/EA/SVB	908993	172	T5B-4-15682/EA/SVB-SW	207426	26
T3-8-SOND*/EZ	907879	168	T5-7-SOND*/EA/SVB-SW	908132	172	T5B-4-15682/I4	207229	121
T3-8-SOND*/Z	907920	168	T5-7-SOND*/I/SVB	908009	172	T5B-4-15682/I4/SVB	207246	132
T3-9-SOND*/E	907858	168	T5-7-SOND*/I/SVB-SW	908140	172	T5B-4-15682/I4/SVB-SW	207247	129
T3-9-SOND*/EZ	907880	168	T5-7-SOND*/Z	908027	172	T5B-4-15682/I4-SI	207254	144
T3-9-SOND*/Z	907921	168	T5-8-SOND*/E	907985	172	T5B-4-15682/I4-SI-SW	207255	143
T4-1-SOND*/EA/SVB	907863	167	T5-8-SOND*/EA/SVB	908994	172	T5B-4-15682/I/SVB	207427	76
T4-1-SOND*/EA/SVB-SW	908082	167	T5-8-SOND*/EA/SVB-SW	908133	172	T5B-4-15682/I/SVB-SW	207428	75
T4-1-SOND*/EZ	907874	167	T5-8-SOND*/I/SVB	908010	172	T5B-4-15682/Z	207429	72
T4-1-SOND*/I2	207498	167	T5-8-SOND*/I/SVB-SW	908141	172	T5B-4-74949GB/E	400002	35
T4-1-SOND*/I2/SVB	207499	167	T5-8-SOND*/Z	908028	172	T5B-4-8213/E	092112	29
T4-1-SOND*/I2/SVB-SW	207500	167	T5-9-SOND*/E	907986	172	T5B-4-8213/I4	207230	135
T4-1-SOND*/I/SVB	907893	167	T5-9-SOND*/EA/SVB	908029	172	T5B-4-8213/Z	092109	81
T4-1-SOND*/I/SVB-SW	908093	167	T5-9-SOND*/EA/SVB-SW	907987	172	T5B-4-8223/E	092108	31
T4-1-SOND*/Z	907915	167	T5-9-SOND*/I/SVB	908030	172	T5B-4-8223/Z	092105	82
T5-1-102/EA/SVB	098808	25	T5B-10-SOND*/E	907933	170	T5B-4-8294/E	092084	29
T5-1-102/EA/SVB-SW	098807	24	T5B-10-SOND*/Z	907977	170	T5B-4-8294/I4	207232	135
T5-1-102/I5/SVB	207273	126	T5B-1-102/E	094471	18	T5B-4-8294/Z	092081	81
T5-1-8200-E-RT	097225	22	T5B-1-102/EA/SVB	094469	25	T5B-4-8344/EA/SVB	092062	25
T5-1-SOND*/E	907978	171	T5B-1-102/EA/SVB-SW	094468	24	T5B-4-8344/EA/SVB-SW	092061	24
T5-1-SOND*/EA/SVB	908031	171	T5B-1-102/E-RT	094470	22	T5B-4-8344/I4/SVB	207248	126
T5-1-SOND*/EA/SVB-SW	908126	171	T5B-1-102/I4	207215	116	T5B-4-8344/I4/SVB-SW	207249	123
T5-1-SOND*/I4	207524	171	T5B-1-102/I4/SVB	207238	126	T5B-4-8344/I/SVB	092056	74
T5-1-SOND*/I4/SVB	207525	171	T5B-1-102/I4/SVB-SW	207239	123	T5B-4-8344/I/SVB-SW	092055	73
T5-1-SOND*/I4/SVB-SW	207526	171	T5B-1-102/I/SVB	094463	74	T5B-4-8410/E	092052	38
T5-1-SOND*/I/SVB	908003	171	T5B-1-102/I/SVB-SW	094462	73	T5B-4-8410/I4	207234	147
T5-1-SOND*/I/SVB-SW	908134	171	T5B-1-102/Z	094460	70	T5B-4-8410/Z	092049	87
T5-1-SOND*/Z	908021	171	T5B-1-8200/E	094281	18	T5B-4-8440/E	092032	34
T5-2-SOND*/E	907979	171	T5B-1-8200/EA/SVB	094279	25	T5B-4-8440/I4	207235	141
T5-2-SOND*/EA/SVB	907988	171	T5B-1-8200/EA/SVB-SW	094278	24	T5B-4-8440/Z	092029	84
T5-2-SOND*/EA/SVB-SW	908127	171	T5B-1-8200-E-RT	094280	22	T5B-4-8441/E	092028	34
T5-2-SOND*/I4	207527	171	T5B-1-8200/I4	207218	116	T5B-4-8441/I4	207236	141
T5-2-SOND*/I4/SVB	207528	171	T5B-1-8200/I4/SVB	207240	126	T5B-4-8441/Z	092025	29
T5-2-SOND*/I4/SVB-SW	207529	171	T5B-1-8200/I4/SVB-SW	207241	123	T5B-4-8902/E	207430	84
T5-2-SOND*/I/SVB	908004	171	T5B-1-8200/I/SVB	094273	74	T5B-4-8902/I4	207237	135
T5-2-SOND*/I/SVB-SW	908135	171	T5B-1-8200/Z	094270	70	T5B-4-8902/Z	207431	81
T5-2-SOND*/Z	908022	171	T5B-1-8210/E	094261	29	T5B-4-8903/I4-SI	207258	144
T5-3-8212/E	096466	29	T5B-1-8210/I4	207432	135	T5B-4-8903/I4-SI-SW	207259	143
T5-3-8212/I5	207266	135	T5B-1-8210/Z	094258	81	T5B-4-SOND*/E	907927	169
T5-3-8212/Z	096464	81	T5B-1-SOND*/E	907924	169	T5B-4-SOND*/EA/SVB	907937	169
T5-3-8342/EA/SVB	096383	25	T5B-1-SOND*/EA/SVB	907934	169	T5B-4-SOND*/EA/SVB-SW	908109	169
T5-3-8342/EA/SVB-SW	096382	24	T5B-1-SOND*/EA/SVB-SW	908106	169	T5B-4-SOND*/I4	207521	169
T5-3-8342/I5/SVB	207279	126	T5B-1-SOND*/I4	207510	169	T5B-4-SOND*/I4/SVB	207522	169
T5-3-8342/I5/SVB-SW	207280	123	T5B-1-SOND*/I4/SVB	207511	169	T5B-4-SOND*/I4/SVB-SW	207523	169
T5-3-8342/I5-SI	207447	144	T5B-1-SOND*/I4/SVB-SW	207512	169	T5B-4-SOND*/I/SVB	907953	169
T5-3-8342/I5-SI-SW	207448	143	T5B-1-SOND*/I/SVB	907950	169	T5B-4-SOND*/I/SVB-SW	908117	169
T5-3-8342/I/SVB	096381	74	T5B-1-SOND*/I/SVB-SW	908114	169	T5B-4-SOND*/Z	907971	169
T5-3-8342/I/SVB-SW	096380	73	T5B-1-SOND*/Z	907988	169	T5B-5-15876/E	214785	36
T5-3-8901/EA/SVB	207408	27	T5B-2-8211/E	093094	29	T5B-5-15876/Z	214786	85
T5-3-8901/EA/SVB-SW	207409	26	T5B-2-8211/I4	207220	135	T5B-5-SOND*/E	907928	170
T5-3-8901/I5/SVB	207277	132	T5B-2-8211/Z	093082	81	T5B-5-SOND*/EA/SVB	907938	170
T5-3-8901/I5/SVB-SW	207278	129	T5B-2-8221/E	093047	31	T5B-5-SOND*/EA/SVB-SW	908110	170
T5-3-SOND*/E	907980	171	T5B-2-8221/I4	207221	136	T5B-5-SOND*/I/SVB	907954	170
T5-3-SOND*/EA/SVB	907989	171	T5B-2-8221/Z	093044	82	T5B-5-SOND*/I/SVB-SW	908118	170
T5-3-SOND*/EA/SVB-SW	908128	171	T5B-2-8400/E	092918	35	T5B-5-SOND*/Z	907972	170
T5-3-SOND*/I4	207530	171	T5B-2-8400/I4	207222	142	T5B-6-SOND*/E	907929	170
T5-3-SOND*/I4/SVB	207531	171	T5B-2-SOND*/E	907925	169	T5B-6-SOND*/EA/SVB	907939	170
T5-3-SOND*/I4/SVB-SW	207532	171	T5B-2-SOND*/EA/SVB	907935	169	T5B-6-SOND*/EA/SVB-SW	908111	170
T5-3-SOND*/I/SVB-SW	908136	171	T5B-2-SOND*/EA/SVB-SW	908107	169	T5B-6-SOND*/I/SVB	907955	170
T5-3-SOND*/Z	908023	171	T5B-2-SOND*/I4	207514	169	T5B-6-SOND*/I4/SVB-SW	908119	170
T5-4-15682/E	207412	23	T5B-2-SOND*/I4/SVB	207515	169	T5B-6-SOND*/Z	907973	170
T5-4-15682/EA/SVB	207413	27	T5B-2-SOND*/I4/SVB-SW	207516	169	T5B-7-15866/E	214788	36
T5-4-15682/EA/SVB-SW	207414	26	T5B-2-SOND*/I/SVB	907951	169	T5B-7-SOND*/E	907930	170
T5-4-15682/I5	207269	121	T5B-2-SOND*/I/SVB-SW	908115	169	T5B-7-SOND*/EA/SVB	907940	170
T5-4-15682/I5/SVB	207281	132	T5B-2-SOND*/Z	907969	169	T5B-7-SOND*/EA/SVB-SW	908112	170
T5-4-15682/I5/SVB-SW	207282	129	T5B-3-8212/E	092386	29	T5B-7-SOND*/I/SVB	907956	170
T5-4-15682/I5-SI	207285	144	T5B-3-8212/I4	207223	135	T5B-7-SOND*/I/SVB-SW	908120	170
T5-4-15682/I5-SI-SW	207286	143	T5B-3-8212/Z	092383	81	T5B-7-SOND*/Z	907974	170
T5-4-15682/I/SVB	207415	76	T5B-3-8222/E	092378	31	T5B-8-SOND*/E	907931	170
T5-4-15682/I/SVB-SW	207416	75	T5B-3-8222/I4	207224	136	T5B-8-SOND*/EA/SVB	907941	170
T5-4-15682/Z	207417	72	T5B-3-8222/Z	092375	82	T5B-8-SOND*/EA/SVB-SW	908113	170
T5-4-8213/E	096014	29	T5B-3-8223/I4	207231	136	T5B-8-SOND*/I/SVB	907957	170
T5-4-8213/I5	207270	135	T5B-3-8228/E	092374	35	T5B-8-SOND*/I/SVB-SW	908121	170
T5-4-8213/Z	096012	81	T5B-3-8228/I4	207225	142	T5B-8-SOND*/Z	907975	170

# Index - By part number

Part number	Article number	Page
T5B-9-SOND*/E	907932	170
T5B-9-SOND*/Z	907976	170
T6-160-15682V/SVB/HI11	200619	76
T6-160-15682V/SVB-SW/HI11	200127	75
T6-160-6I45/SVB/HI11	201448	132
T6-160-6I45/SVB-SW/HI11	201447	129
T6-3-8212/E/HI12	214781	29
T8-3-8212/E/HI12	214782	29
T8-3-8342I48/SVB/HI11	201450	132
T8-3-8342I48/SVB-SW/HI11	201449	129
T8-3-8342V/SVB/HI11	200620	76
T8-3-8342V/SVB-SW/HI11	200128	75
TM-1-15431/E	025045	33
TM-1-15431/EZ	000691	58
TM-1-15431/IVS	225342	104
TM-1-8175/EZ	015690	50
TM-1-8178/E	098608	19
TM-1-8178/EZ	016786	50
TM-1-8210/E	096234	28
TM-1-8210/EZ	015137	53
TM-1-8214/E	032164	30
TM-1-8220/E	081996	28
TM-1-8220/EZ	000692	53
TM-1-8220F88/EZ	016925	58
TM-1-8240/E	058267	40
TM-1-8240/EZ	015226	63
TM-1-8290/E	070131	18
TM-1-8290/EZ	000693	49
TM-1-8291/E	072504	18
TM-1-8291/EZ	015073	49
TM-1-8310/EZ	045479	57
TM-1-8311/EZ	045487	57
TM-1-SOND*/E	907749	173
TM-1-SOND*/E	907755	173
TM-1-SOND*/IVS	225346	173
TM-1-SOND-ERSTBESTELLUNG/E	208261	173
TM-1-SOND-ERSTBESTELLUNG/EZ	208262	173
TM-1-SOND-ERSTBESTELLUNG/IVS	225347	173
TM-2-15432/E	027418	33
TM-2-15432/EZ	016878	58
TM-2-8211/E	098607	28
TM-2-8211/EZ	015166	53
TM-2-8215/E	034537	30
TM-2-8219/E	017926	28
TM-2-8221/E	084369	28
TM-2-8221/EZ	015197	53
TM-2-8230/E	039283	39
TM-2-8230/EZ	000701	66
TM-2-8231/E	044029	39
TM-2-8231/EZ	000700	66
TM-2-8241/E	065386	40
TM-2-8241/EZ	015256	63
TM-2-8260/E	060640	40
TM-2-8260/EZ	045483	63
TM-2-8292/E	074877	18
TM-2-8292/EZ	015096	49
TM-2-8293/E	077250	18
TM-2-8293/EZ	045486	49
TM-2-8550/E	020300	32
TM-2-8550/EZ	000699	55
TM-2-SOND*/E	907763	173
TM-2-SOND*/EZ	907756	173
TM-2-SOND*/IVS	225348	173
TM-2-SOND-ERSTBESTELLUNG/E	208263	173
TM-2-SOND-ERSTBESTELLUNG/EZ	208264	173
TM-2-SOND-ERSTBESTELLUNG/IVS	225349	173
TM-3-15433/E	029791	33
TM-3-15433/EZ	045490	58
TM-3-8212/E	010807	28
TM-3-8212/EZ	045491	53
TM-3-8222/E	086742	28
TM-3-8222/EZ	045493	53
TM-3-8232/E	039298	39
TM-3-8232/EZ	015592	66
TM-3-8233/E	053521	39
TM-3-8233/EZ	015630	66
TM-3-8242/E	072505	40
TM-3-8242/EZ	015506	63
TM-3-8243/E	079624	40
TM-3-8243/EZ	015537	63
TM-3-8244/E	081997	40
TM-3-8244/EZ	045495	63
TM-3-8256/E	079623	18
TM-3-8261/E	067759	40
TM-3-8261/EZ	000698	63
TM-3-8280/E	063013	40
TM-3-8280/EZ	045496	63
TM-3-8299/E	020299	28
TM-3-8401/E	015554	35
TM-3-SOND*/E	907750	173
TM-3-SOND*/EZ	907757	173
TM-3-SOND-ERSTBESTELLUNG/E	208265	173
TM-3-SOND-ERSTBESTELLUNG/EZ	208266	173
TM-4-8213/E	013180	28
TM-4-8213/EZ	045847	53
TM-4-8223/E	089115	28
TM-4-8223/EZ	046119	53
TM-4-8262/E	074878	40
TM-4-8262/EZ	046120	63
TM-4-8552/E	025046	32
TM-4-SOND*/E	907751	173
TM-4-SOND*/EZ	907758	173
TM-4-SOND-ERSTBESTELLUNG/E	208267	173
TM-4-SOND-ERSTBESTELLUNG/EZ	208268	173
TM-5-8237/E	069150	39
TM-5-8237/EZ	015661	66
TM-5-8247/E	009741	40
TM-5-8247/EZ	015565	63
TM-5-8252/E	041671	39

Part number	Article number	Page
TM-5-8252/EZ	046123	66
TM-5-8270/E	041656	39
TM-5-8270/EZ	046124	66
TM-5-8281/E	070132	40
TM-5-8281/EZ	046125	63
TM-5-8369/E	091488	28
TM-5-8369/EZ	046126	53
TM-5-SOND*/E	907764	173
TM-5-SOND*/EZ	907759	173
TM-5-SOND-ERSTBESTELLUNG/E	208269	173
TM-5-SOND-ERSTBESTELLUNG/EZ	208270	173
TM-6-8253/E	046127	66
TM-6-8253/E	055894	39
TM-6-8271/E	046402	39
TM-6-8271/EZ	046128	66
TM-6-8282/E	077251	40
TM-6-8370/E	093861	28
TM-6-SOND*/E	907752	173
TM-6-SOND*/EZ	907760	173
TM-6-SOND-ERSTBESTELLUNG/E	208271	173
TM-6-SOND-ERSTBESTELLUNG/EZ	208272	173
TM-7-SOND*/E	907753	173
TM-7-SOND*/EZ	907761	173
TM-7-SOND-ERSTBESTELLUNG/E	208273	173
TM-7-SOND-ERSTBESTELLUNG/EZ	208274	173
TM-8-SOND*/E	907754	173
TM-8-SOND*/EZ	907762	173
TM-8-SOND-ERSTBESTELLUNG/E	208275	173
TM-8-SOND-ERSTBESTELLUNG/EZ	208276	173
UV-P3	048289	161
UV-T0	019925	161
V/E/SVB/T5	045065	154
V/E/SVB-SW/T5	045064	154
V/E/SVB-SW-T0	065011	154
V/E/SVB-T0	062638	154
V-M25	206911	151
VR-T0	089082	158
VR-T3	050987	158
ZAV(X1)+ZVV(X1)-T0/P3	254546	92
ZAV-P3	029417	92
ZAV-P5	280979	92
ZAV-T0	027044	92
ZFS(*)-P5	105225	156
ZFS80-P3	022297	156
ZFS80-T0	019924	156
ZFS81/62/P3	065739	156
ZFS81/62-T0	030170	156
ZFS83-P3	047423	156
ZFS83-T0	047424	156
ZFS88-T0	065751	156
ZFS77-P3	047422	156
ZFS77-T0	065752	156
ZFS80-P3	205565	156
ZFS80-T0	205548	156
ZFSX-P3	027043	156
ZFSX-T0	024670	156
ZVV-P3	024671	92
ZVV-T0	022298	92









We make what matters work.\*



At Eaton, we believe that power is a fundamental part of just about everything people do. That's why we're dedicated to helping our customers find new ways to manage electrical, hydraulic and mechanical power more efficiently, safely and sustainably. To improve people's lives, the communities where we live and work, and the planet our future generations depend upon. Because this is what really matters. And we're here to make sure it works.

To learn more go to: [Eaton.com/WhatMatters](https://www.eaton.com/WhatMatters)

**EATON**  
Powering Business Worldwide

**We make what matters work.**

Eaton is an intelligent power management company dedicated to improving the quality of life and protecting the environment for people everywhere. We are guided by our commitment to do business right, to operate sustainably and to help our customers manage power ☑ today and well into the future. By capitalizing on the global growth trends of electrification and digitalization, we're accelerating the planet's transition to renewable energy, helping to solve the world's most urgent power management challenges, and doing what's best for our stakeholders and all of society.

Founded in 1911, Eaton has been listed on the NYSE for nearly a century. We reported revenues of \$19.6 billion in 2021 and serve customers in more than 170 countries. For more information, visit [www.eaton.com](http://www.eaton.com). Follow us on Twitter and LinkedIn.

**Eaton Industries GmbH**

Hein-Moeller-Str. 7-11  
D-53115 Bonn/Germany

**Eaton Electrical Products Limited**

Unit 1, Hawker Business Park  
Melton Road  
Burton-on-the-Wolds  
LE12 5TH

Changes to the products, to the information contained in this document, and to prices are reserved; so are errors and omissions. Only order confirmations and technical documentation by Eaton is binding. Photos and pictures also do not warrant a specific layout or functionality. Their use in whatever form is subject to prior approval by Eaton. The same applies to Trademarks (especially Eaton, Moeller, and Cutler-Hammer). The Terms and Conditions of Eaton apply, as referenced on Eaton Internet pages and Eaton order confirmations.

© 2022 Eaton  
All Rights Reserved  
PDF Only  
Publication No. CA042001EN  
September 2022

Eaton is a registered trademark.

All other trademarks are property of their respective owners.

Follow us on social media to get the latest product and support information.



Powering Business Worldwide