

Features

- High conductivity
- Corrosion resistant
- Vinyl insulated
- Vibration resistant

RS PRO Red Double Crimp Ring M5

RS Stock No.: 0677153



RS PRO is the own brand of RS. The RS PRO Seal of Approval is your assurance of professional quality, a guarantee that every part is rigorously tested, inspected, and audited against demanding standards. Making RS PRO the Smart Choice for our customers.

Ensure reliable and safe electrical connections with our high-quality insulated double copper sleeve terminals. These terminals provide superior conductivity feature a protective tin plating to resist corrosion. The durable insulation adds an extra layer of safety, preventing short circuits and ensuring long-lasting performance. Their dual-grip design provides a secure hold, even under high vibration, making them ideal for demanding applications.

General Specifications

Type	Double Copper Sleeved
Connector Type	Ring
Contact Plating	Tin
Contact Material	Copper

Electrical Specifications

Insulation Material	PVC
---------------------	-----

Operation Environment Specifications

Temperature Rating	75°C max
--------------------	----------

Approvals

Compliance/Certifications	REACH, RoHS, UL
Declarations	

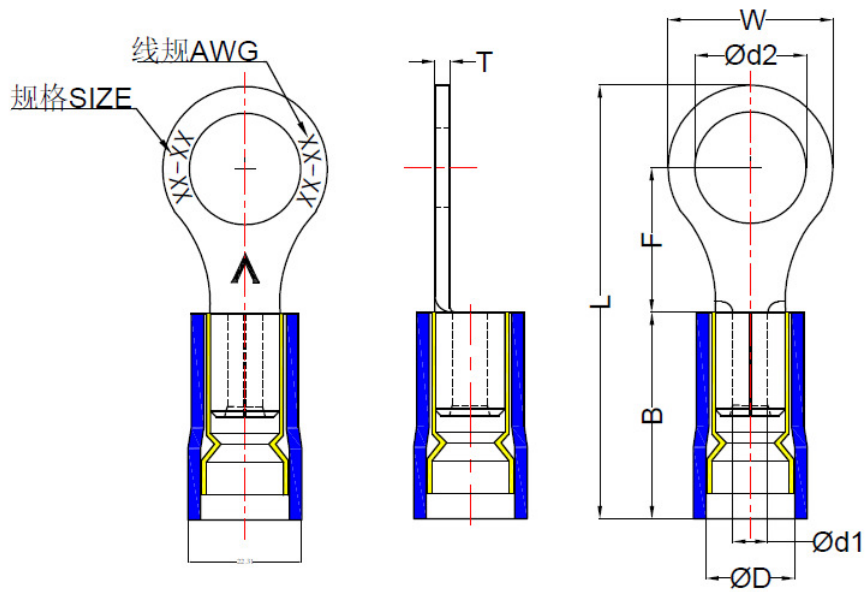

Drawing Specifications

Od2	5.3mm
W	8.0mm
F	7.0mm
L	22.1mm
B	11.3mm
OD	4.3mm
Od1	1.7mm
T	0.75mm
Size	1-5
AWG	22-16
Colour	Red