

Operation Instructions

# METRA HIT 28S

# METRA HIT 29S

Precision Digital Multimeter

3-348-851-03

13/2.06



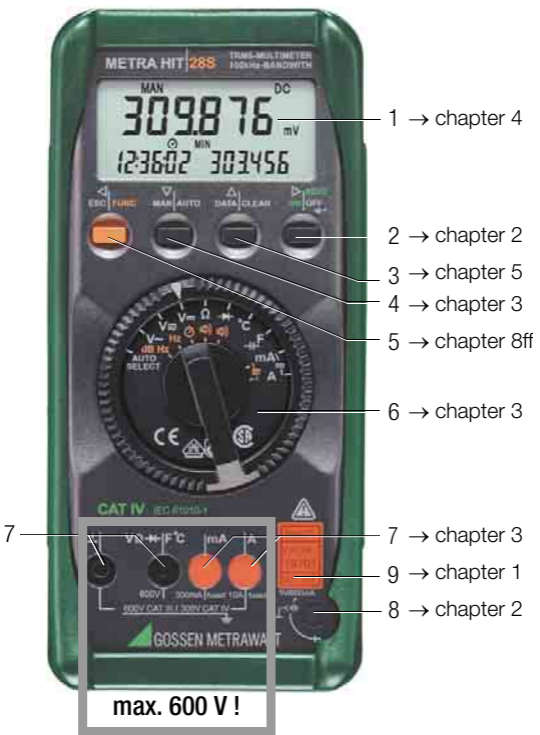

- 1 LCD Display
- 2 **MENU/ON/OFF** ON / OFF key  
*Operating Mode Menu:* Entry acknowledgment
- 3 **DATA/CLEAR** Function key for measurement value store, delete and MIN-MAX  
*Operating Mode Menu:* Individual menu item selection reverse flux direction, increase values
- 4 **MAN/AUTO** Manual measuring range selection key  
*Operating Mode Menu:* Individual menu item selection forward flux direction, reduce values
- 5 **ESC/FUNC** Multifunction key  
*Operating Mode Menu:* Exit menu level and return to next highest level, exit parameter entry mode without storage of values
- 6 **Rotary switch** for measurement functions
- 7 Connection jacks
- 8 Power pack connection jack
- 9 DKD calibration mark

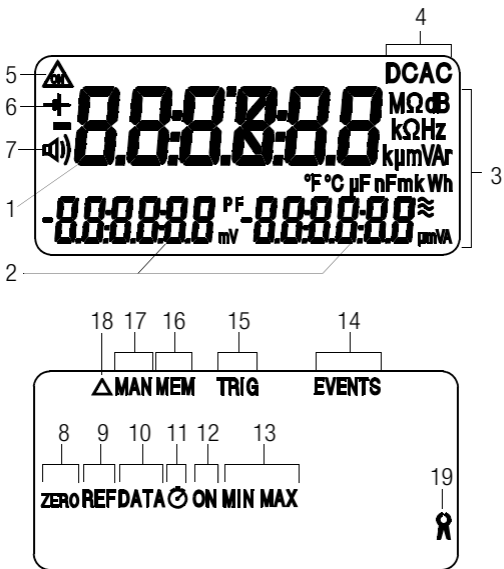

### Digital Display Symbols

- 1 Main display with decimal point and indication of polarity
- 2 Sub-displays with decimal point and indication of polarity
- 3 Unit of measure
- 4 Selected current type
- 5 Continuous operation, symbol blinks for data transmission
- 6 Low battery
- 7 Acoustic signal on, buzzer activated for corresponding function
- 8 Zero balancing
- 9 Reference value
- 10 Memory display, "hold measurement value"
- 11 Stopwatch activated or elapsed time since start of measurement
- 12 Together with symbol 11:  
elapsed time since activation of corresponding function, counter,  
number of events when trigger threshold is exceeded
- 13 MIN-MAX storage
- 14 Event marking
- 15 Synchronized storage, METRA HIT 29S only
- 16 Memory mode, METRA HIT 29S only
- 17 Manual measuring range selection
- 18 Relative value
- 19 Measurement with clip-on current transformer active:  
Factor 1000 or 10000 is considered

Contents	Page
<b>1</b>	<b>Safety Features and Precautions ..... 6</b>
<b>2</b>	<b>Initial Start-Up ..... 8</b>
<b>3</b>	<b>Selection of Measurement Functions and Measuring Ranges ..... 10</b>
3.1	Automatic Measuring Range Selection ..... 10
3.2	Manual Measuring Range Selection ..... 10
3.3	Quick Measurements ..... 11
<b>4</b>	<b>Triple Digital Display ..... 11</b>
<b>5</b>	<b>Measurement Value Storage “DATA” (Hold &amp; Compare) ..... 12</b>
<b>6</b>	<b>Minimum and Maximum Value Storage “MIN-MAX” with Time Stamp ..... 14</b>
<b>7</b>	<b>Auto Select ..... 16</b>
<b>8</b>	<b>Voltage Measurement ..... 17</b>
8.1	Transient Overvoltages ..... 18
8.2	Voltage Measurements for Greater than 600 V ..... 18
8.3	Alternating Voltage Level Measurement (dB) ..... 19
<b>9</b>	<b>Current Measurement ..... 21</b>
9.1	Measurement with (Clip-On) Current Transformers ..... 22
9.1.1	Transformer Output mA or A for AC Measurements ..... 22
9.1.2	Transformer Output V for AC and DC Measurements ..... 23
<b>10</b>	<b>Resistance Measurement ..... 24</b>
<b>11</b>	<b>Continuity Testing for Resistance Measurement ..... 25</b>
<b>12</b>	<b>Diode Testing ..... 26</b>
<b>13</b>	<b>Continuity Testing for Diode Tests ..... 27</b>
<b>14</b>	<b>Capacitance Measurement ..... 28</b>
<b>15</b>	<b>Frequency Measurement ..... 29</b>
<b>16</b>	<b>Temperature Measurement ..... 30</b>
16.1	Temperature Measurement with Pt100 and Pt1000 ..... 30
16.2	Temperature Measurement with Thermocouple and Reference Junction ..... 30
<b>17</b>	<b>Counting Events and Zero Crossings ..... 32</b>
17.1	Event Counting ..... 32
17.2	Count Zero Crossings ..... 34
<b>18</b>	<b>Stopwatch ..... 34</b>
<b>19</b>	<b>Δ Operating Mode, Reference Value <i>REF.</i> ..... 36</b>

	Page
<b>20</b>	<b>Power Measurement with the METRA HIT 29S ..... 38</b>
20.1	Power Measurement with Analog Signals I and V ..... 38
20.2	Energy Measurement with Pulses ..... 40
20.3	EnErGY Menu for Energy Measurement ..... 41
20.4	Exit Power/Energy Measurement ..... 42
20.5	Power Measurement with (Clip-On) Current Transformers ..... 42
<b>21</b>	<b>Line Fault Recording with the METRA HIT 29S ..... 43</b>
21.1	Line Fault Recording without Memory Mode ..... 43
21.2	Trigger Parameters for Line Fault Recording ..... 46
21.3	Line Fault Recording with Memory Mode ..... 47
<b>22</b>	<b>Storing Measurement Values with the METRA HIT 29S 47</b>
22.1	General Parameters ..... 50
22.2	Trigger Functions ..... 51
22.2.1	Trigger Function Parameters ..... 52
<b>23</b>	<b>Setting the Measurement Parameters ..... 56</b>
23.1	Description of General Parameters in the <i>SEt</i> Menu ..... 58
23.1.1	Sampling Rate: <i>rAtE</i> . ..... 58
23.1.2	Rapid Query: <i>MenuCYCLE</i> . ..... 58
23.1.3	<i>tiME</i> und Datum <i>dAtE</i> ..... 58
23.2	Parameter Description of Menu Item: <i>inFo</i> . ..... 59
23.3	Default Settings ..... 59
23.4	List of All Parameters ..... 60
<b>24</b>	<b>Data Transmission via the RS 232 Interface ..... 61</b>
24.1	Activating the Interface ..... 61
24.2	Selecting Interface Parameters ..... 62
<b>25</b>	<b>Characteristic Values ..... 64</b>
<b>26</b>	<b>Maintenance ..... 74</b>
26.1	Battery ..... 74
26.2	Power Pack ..... 75
26.3	Fuses ..... 75
26.4	Housing ..... 76
<b>27</b>	<b>Multimeter Messages ..... 76</b>
<b>28</b>	<b>Accessories ..... 77</b>
28.1	General ..... 77
28.2	Characteristic Values of Measuring Cables (Scope of Supply of Safety Cable Set KS17-2) ..... 77
<b>29</b>	<b>Repair and Replacement Parts Service DKD Calibration Lab and Rental Instrument Service ..... 77</b>
<b>30</b>	<b>Warranty ..... 78</b>
<b>31</b>	<b>Product Support ..... 79</b>

# 1 Safety Features and Precautions

You have selected an instrument which provides you with a high level of safety.

This instrument fulfills the requirements of the applicable European and national EC guidelines. We confirm this with the CE marking. The relevant declaration of conformity can be obtained from GMC-I Gossen-Metrawatt GmbH.

The precision digital multimeter is manufactured and tested in accordance with safety regulations IEC 61010–1:2001/ DIN EN 61010–1:2001/ VDE 0411–1:2002. When used for its intended purpose, safety of the operator, as well as that of the instrument, is assured. Their safety is however not guaranteed, if the instrument is used improperly or handled carelessly.

In order to maintain flawless technical safety conditions, and to assure safe use, it is imperative that you read the operating instructions thoroughly and carefully before placing your instrument into service, and that you follow all instructions contained therein.

For your safety, as well as for the protection of your instrument, the multimeter is equipped with an automatic socket blocking device. This is coupled to the rotary switch, and only allows connection to the socket required for the selected function. It also prevents the switching of the rotary selector to disallowed functions when a measurement cable is plugged into a socket. Exception METRA HIT 29S: in switch position W/mA or W/A jack V remains open for power measurement, in position W/A jack mA is only partially covered or blocked.

## **Use for Intended Purpose:**

- The multimeter described herein is a portable instrument which can be held in one hand during measurements.
- Only such measurements are performed as described in chapters 8 to 21.
- The measuring instrument including measuring cables and plug-on test probes is only used within the measuring category indicated under the heading "Electrical Safety" on page 72 (refer to the table on page 7 for the meaning of the measuring categories).
- The limits of the overload capacity may not be exceeded. Refer to the Characteristic Values on page 66 and page 70 for the duration and values of the overload capacity.
- Measurements are only performed within the specified ambient conditions. Refer to page 73 for the operating temperature range and relative humidity.
- The measuring instrument is only used in accordance with the specified protection type, see page 73.

## **Observe the following safety precautions:**

- The instrument may only be operated by persons who are capable of recognizing contact hazards and taking the appropriate safety precautions. Contact hazards exist anywhere, where voltages of greater than 33 V may occur (effective value).

- Avoid working alone when taking measurements which involve contact hazards. Be certain that a second person is present.
- **The maximum allowable voltage between any given connector jack (7) and earth is equal to 600 V, category III or to 300 V, category IV.**
- Be prepared for the occurrence of unexpected voltages at devices under test (e.g. defective devices). For example, capacitors can be dangerously charged.
- Make certain that the measurement cables are in flawless condition, e.g. no damage to insulation, no interruptions in cables or plugs etc.
- No measurements may be made with this instrument in electrical circuits with corona discharge (high-voltage).
- Special care is required when measurements are made in HF electrical circuits. Dangerous pulsating voltages may be present.
- Measurements under moist ambient conditions are not allowable.
- Be absolutely certain that the *measuring ranges are not overloaded beyond their allowable capacities*. Limit values can be found in the table "Measuring Ranges" in Chapter 25 „Characteristic Values“.
- All current ranges are equipped with fuses (Nominal voltage of fuse = 1000 V). The maximum allowable voltage for the measuring current circuit (= rated voltage of the fuse) is equal to 600 V AC/DC in the "mA" and "A" ranges.
- **In switch position AUTO SELECT,  $\Omega$ ,  $\rightarrow$ , °C and F, the instrument may only be used in power installations when the electrical circuit is protected with a fuse or circuit breaker up to 20 A, and the nominal voltage of the installation does not exceed 600 V in order to provide protection also under single-fault conditions (EN 61010-1).**

#### Measuring Categories and their Meaning per IEC 61010-1

CAT	Definition
I	Measurements in electrical circuits not directly connected to the mains system: <i>e. g. power systems in motor vehicles or aeroplanes, batteries ...</i>
II	Measurements in electrical circuits directly connected to the low-voltage system: <i>via plug, e.g. in households, offices, laboratories ...</i>
III	Measurements in facility installations: <i>stationary consumers, distributor connections, devices attached to a distributor</i>
IV	Measurements at the source of low-voltage installations: <i>Meters, main terminal, primary overcurrent protection devices</i>

The measurement category and the relevant maximum rated voltage (e. g. 600 V CAT III) which are shown on the instrument casing apply to your measuring instrument.

## Meaning of symbols on the instrument



Warning concerning a point of danger  
(Attention: observe documentation)



Earth



Continuous, doubled or reinforced  
insulation

**CAT III / IV** Instrument for measurement category III or IV



VDE testing authority approval mark



CSA approval mark  
(North American test authority)



Indicates EU conformity

### DKD calibration mark (red seal):



Serial number

German Calibration Service – Calibration Laboratory

GOSSEN METRAWATT Calibration Laboratory

Date of calibration

## Repair, Parts Replacement and Balancing

When the instrument is opened, voltage conducting parts may be exposed. The instrument must be disconnected from the measuring circuit for repair, replacement of parts or balancing. If repair or balancing of a live, open instrument is required, this may only be carried out by trained personnel who are familiar with the dangers involved.

### Errors and Extraordinary Strains

If it may be assumed that the instrument can no longer be operated safely, it must be removed from service and secured against unintentional use.

Safe operation can no longer be relied upon,

- if the instrument demonstrates visible damage,
- if the instrument no longer functions,
- after a long period of storage under unfavorable conditions.

## 2 Initial Start-Up

### Battery

Please refer to chapter 26.1 regarding correct battery installation.



### Attention!

Before opening the instrument, disconnect it from the measuring circuit!



## Operation with mains adapter

(accessory equipment, not included as a standard feature)

During power supply via mains adapter NA5/600, the inserted batteries are cut off electronically so that they may remain in the instrument, see also chapter 26.2. If rechargeable batteries are used, they must be charged outside the instrument.

## Switching the Instrument On Manually

➤ Press the ON key.

Activation is acknowledged with a brief acoustic signal. As long as the key remains pressed, all segments of the liquid crystal display (LCD) are active. The LCD is shown on page 3. After the key is released, the instrument is ready for operation.

## Switching the Instrument On via PC

After transmission of a data block from the PC, the multimeter is switched on. See also chapter 24.

## Automatic Activation/Deactivation

To extend battery life, the multimeter is switched on and off automatically in the transmit and data storage modes provided the transmit/storage interval **rate** is set at  $\geq 10$  s.



### Note!

Electrical discharge and high frequency interference can cause incorrect displays, and may block the measuring sequence. To reset, switch the instrument off, and then back on. If this procedure is unsuccessful, briefly disconnect the battery from the contact terminals.

---

## Setting Time and Date

See Chapter 23.1.3, page 58.

## Switching the Instrument Off Manually

➤ Press and hold the ON key, until the display is deactivated. Deactivation of the instrument is acknowledged by two brief acoustic signals.

## Automatic Shut-Off

Your instrument shuts itself off automatically, if the measurement value remains constant for a long period of time (maximum measurement value fluctuation: approx. 0.8% of the measuring range per minute or 1 °C or 1 °F per minute), and if none of the keys or the rotary switch are activated for a period of 10 minutes. Deactivation of the instrument is acknowledged by a brief acoustic signal. Exceptions are as follows:

Event counting, count zero crossing, stopwatch, transmit or memory mode, continuous operation, power measurement and line fault recording.

## Disabling of Automatic Shut-Off

The instrument can also be switched to "CONTINUOUS ON".

➤ Simultaneously press the ON key and the multifunction key ESCIFUNC when switching the instrument on. The "CONTINUOUS ON" function is indicated at the LCD with the  symbol.

### 3 Selection of Measurement Functions and Measuring Ranges

The rotary switch is coupled to the automatic socket blocking device, which makes two jacks available for each function (except mA and A: 3 jacks. The jack for the “mA” socket in the “A” function is half open). Before switching to the “mA” or “A” functions, or out off the “mA” or “A” functions, be certain that the plug has been removed from the corresponding jack. The socket blocking device prevents inadvertent switching to disallowed functions when a plug connection exists.

#### 3.1 Automatic Measuring Range Selection

The multimeter is equipped with automatic measuring range selection for all measuring ranges, except for temperature measurement and diode testing, as well as respective continuity testing. This automatic feature is active as soon as the instrument is switched on. The instrument automatically selects the measuring range which provides optimum resolution for the current measured quantity. The previously selected voltage measuring range remains active after switching the instrument to frequency measurement, events counting or count zero crossing. The instrument is automatically switched to the next highest or next lowest measuring range for the following measured quantities:

Measuring Range	Resolution	Switching to the Next Highest Range at $\pm(\dots d + 1 d)$	Switching to the Next Lowest Range at $\pm(\dots d - 1 d)$
V $\overline{\sim}$ , mA $\overline{\sim}$ , $\Omega$ , Hz <sup>1)</sup>	5 %	310,000	28,000
V $\sim$ , V $\overline{\sim}$ , A $\overline{\sim}$ , mA $\sim$ , A $\sim$ , 30 mF	4 %	31,000	2,800
3 nF ... 3 mF	3 %	3,100	280

<sup>1)</sup> 2800 digits apply when switching from 300 kHz to 30 kHz.

#### 3.2 Manual Measuring Range Selection

The automatic measuring range feature can be deactivated and the ranges can be manually selected and prescribed according to the following table.

The manual mode is deactivated by pressing and holding the MAN/AUTO key (approx. 1s), by activating the rotary switch or by switching the instrument off and back on again.

↓ MAN/ AUTO	Function	Acknowledge	
		Display	Acoust. Signal
Brief	Manual Mode Active: selected measuring range is fixed	MAN	1 x
Brief	Switching Sequence for: <b>V:</b> 300 mV → 3 V → 30 V → 300 V → 600 V → 300 mV → ... <b>dB:</b> same switching sequence as for V $\sim$ <b>mA:</b> 300 $\mu$ A → 3 mA → 30 mA → 300 mA → 300 $\mu$ A ... <b>A:</b> 3 A → 10 A → 3 A ... <b><math>\Omega</math>:</b> 30 M $\Omega$ → 300 $\Omega$ → 3 k $\Omega$ → 30 k $\Omega$ → 300k $\Omega$ → 3 M $\Omega$ → 30 M $\Omega$ ... <b>F:</b> 3 nF → 30 nF → 300 nF → 3 $\mu$ F → 30 $\mu$ F → 300 $\mu$ F → 3000 $\mu$ F → 30000 $\mu$ F → 3 nF ... <b>Hz:</b> 300 Hz → 3 kHz → 300 kHz → 300 Hz ...	MAN	1 x
Long	Return to Automatic Range Selection	—	2 x

### 3.3 Quick Measurements

If you wish to perform quicker measurements than those possible with the automatic measuring range selection function, make sure to establish the appropriate measuring range:

- by **manual measuring range selection**, i. e. by selecting the measuring range with the best resolution, see chapter 3.2.

or

- via **DATA function**, see chapter 5. After the first measurement, the proper measuring range will be automatically determined so that measurements are performed more rapidly from the second measured value onwards.

With both functions, the established measuring range is maintained for the subsequent series mode measurements.

### 4 Triple Digital Display

The three digital displays, one main display and two sub-displays, show the measurement value with correct decimal point and sign. The selected unit of measure and the current type are also displayed. A minus sign appears in front of the number for the measurement of zero-frequency direct quantities, if the positive pole of the measured quantity is applied to the “ $\perp$ ” input.

“OL” (overload) is displayed, if the actual value falls below the measuring range lower limit for the following measured quantities:

V DC, I DC, $\Omega$ , Hz:	309999
V (AC, AC+DC), I (AC+DC), dB (V), 30 mF:	30999
W, VA, VAR, Wh (METRA HIT 29S):	30999
3 nF ... 3 mF:	3099

Refreshing of the digital display occurs at different intervals for the various measured quantities (see display update page 71).

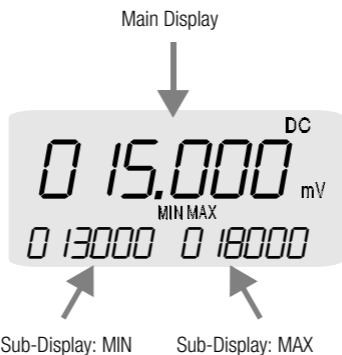

Although the main display is activated immediately after the multimeter is switched on, the two sub-displays must be activated with the DATA/CLEAR key. This prevents the continuous display of an undefined condition which was present at the start of measurement, e.g. open-circuit, as a maximum value.

## 5 Measurement Value Storage “DATA” (Hold & Compare)

Measurement values can be automatically “frozen” with the DATA (Hold) function. This can be especially useful when your full attention is required for testing the measuring point with the test probes.

After the measurement value has been acquired, and the appropriate “condition” has been fulfilled according to the following table, the measurement value is displayed in the left hand sub-display and two acoustic signal sounds. At the same time “MAN” appears and indicates that the measuring range is now set. The test probes can now be removed from the measuring point and the measurement value can be read from the sub-display. If the measurement value lies below the limit value shown in the table, the instrument is reactivated for the storage of a new value; the “DATA” display blinks.

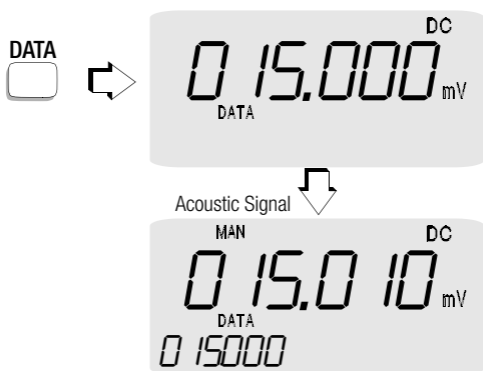

### Comparison of measurement values (DATA Compare)

If the newly stored measurement value deviates less than 0.33% of the measuring range from the first measurement value, the acoustic signal (DATA Compare) sounds twice. If it deviates more than 0.33% from the measuring range, only a brief signal sounds.

Function DATA	↓ DATA	Condition		Response at Instrument		
		Measuring Function	Measurement Value	Sub-Display Meas. Value	DATA	Acoustic Signal
Switch on	brief					brief
Store (stabilized mea- surement value)		V, dB <sup>2)</sup> , A F, Hz	> 3.3% <sup>5)</sup> of MR	is dis- played	is dis- played	brief 2x <sup>4)</sup>
		$\Omega$ <sup>3)</sup> , $\rightarrow$ <sup>3)</sup>	OL <sup>5)</sup>			
Reactivate <sup>1)</sup>		V, dB <sup>2)</sup> , A F, Hz	< 3.3% <sup>5)</sup> of MR	stored meas. value	blinks	
		$\Omega$ <sup>3)</sup> , $\rightarrow$ <sup>3)</sup>	OL <sup>5)</sup>			
Switch to function MIN/MAX	brief	see Table chapter 6				
Quit	long			is deleted	is deleted	2x

- 1) Reactivation when actual value falls below prescribed limit value  
2) Relative to alternating voltage values  
3) Also applies to continuity testing  
4) When a measurement value is stored for the first time as a reference value, the acoustic signal sounds twice. For subsequent storage of the same measurement value, the acoustic signal sounds only twice if the subsequently stored measurement value deviates from the first value by less than 0.33% of the measuring range dependent upon resolution.  
5) Exception: 10% at 300  $\Omega$  or 3 nF

## Abbreviations

MR = Measuring range

As long as the DATA function is active, the measuring ranges should not be changed manually.

The DATA function is deactivated if the DATA|CLEAR key is pressed and held (approx. 1 s), if the rotary switch is activated or if the instrument is switched off and back on again.

## 6 Minimum and Maximum Value Storage "MIN-MAX" with Time Stamp

Minimum and maximum values can be read out at the sub-displays for long-term observation of measured quantities.

- ⇨ If the DATA/CLEAR key is activated twice, current MIN and MAX values are displayed at the sub-displays.
- ⇨ Press the DATA/CLEAR key again to display the MIN value and the time of occurrence.
- ⇨ If the DATA/CLEAR key is once again activated, the MAX value and the corresponding time of occurrence are displayed.

MIN and MAX values are deleted by pressing and holding the DATA/CLEAR key (approx. 1 s), by activating the rotary switch or by switching the instrument off and back on again.

Function MIN/MAX	↓ DATA	MIN and MAX Measurement Values/ Time of Measurement	Reaction at Instrument		
			Main Display	Sub- Displays	Acoust Signal
1. Store	2 x brief ↓ ↓	are stored	current measurement value	MIN and MAX	1 x
2. Store and display	brief ↓	are stored		t and MIN	1 x
	brief ↓			t and MAX	1 x
3. Return to 1.	brief ↓	are stored	same as 1.	same as 1.	1 x
Cancel	long ↓	are deleted	is deleted	is deleted	2 x



### Note!

No new MIN-MAX values are determined for 2 seconds after a change of measuring range, so that measurement values can stabilize.



Current Measurement Value

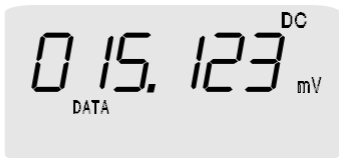
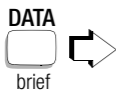

Current Measurement Value

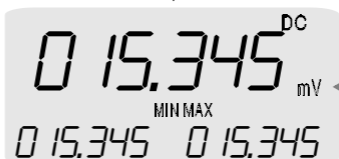
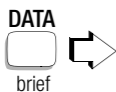

Current Meas. Value

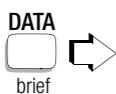

Current Meas. Value

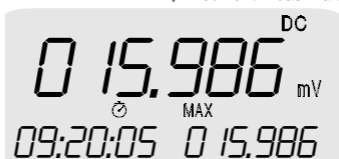
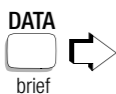

Current Meas. Value

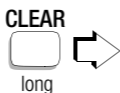
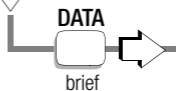

## 7 Auto Select

In the Auto Select switch position, the auto-select function (automatic selection of measuring function) allows for autonomous recognition of the measured quantity, which is applied between earth and the voltage jacks.

An overview of possible measured quantities as well as the respective prerequisites for recognition can be found in the AUTO SELECT table on page 67.



### Note!

Diodes must be connected from the anode side (“+” pole) to the  $\rightarrow$  jack.

For polarized capacitors, the “+” pole must be connected to the “F” jack and the “-” pole to the “ $\perp$ ” jack.

Resistors and semiconductor paths connected in parallel to the capacitor distort measurement results!

⇒ Set the rotary switch to AUTO SELECT.



OPEN



### Attention!

In the auto-select function, **no more than 600 V<sub>TRMS</sub>** may be applied between “ $\perp$ ” and “V” jacks.

⇒ Connect the measurement cables as shown. The “ $\perp$ ” jack should be grounded.

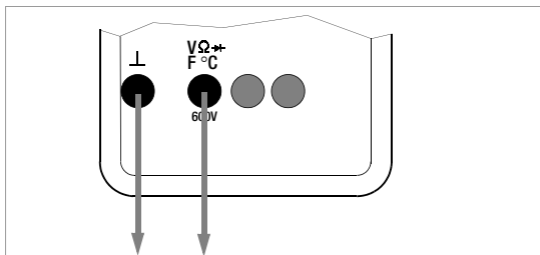

### Note!

The following chapter contains more information concerning individual measured quantities.



## 8 Voltage Measurement

- Depending upon the voltage to be measured, set the rotary switch to  $V \sim$ ,  $V \equiv$  or  $V \approx$ .



0 15.000<sup>DC</sup> mV

- Connect the measurement cables as shown. The “⊥” jack should be grounded.



### Note!

In the 600 V range, an intermittent acoustic signal sounds alarm if the measurement value exceeds 1000 V.



### Attention!

*Make absolutely certain that neither of the current ranges (“mA” or “A”) is active when the multimeter is connected for voltage measurements! If the fuse trip limits are exceeded due to operator error, both the operator and the instrument are in danger!*

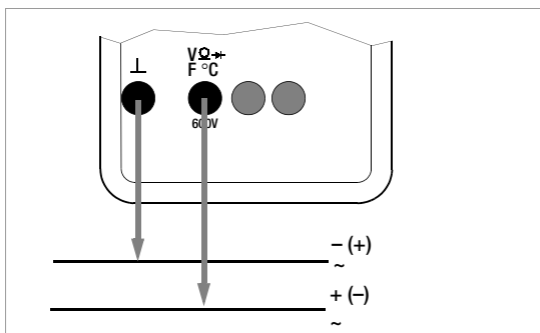

### Zero Balancing in the 300 mV $\equiv$ Measuring Range

- Select the 300 mV  $\equiv$  measuring range.
- Connect the measurement cables to the instrument, and connect the free cable ends to one another.
- Briefly press the multifunction key ESC/FUNC.



The instrument acknowledges zero balancing with an acoustic signal and “000.000” ( $\pm 1$  digit) and the “ZERO” symbol appear at the LCD. The voltage which was displayed at the moment the key was activated serves as a reference value (max.  $\pm 20000$  digits). It is automatically subtracted from subsequently measured values.

⇒ Zero balancing can be deleted:

- by pressing and holding the multifunction key ESC/FUNC, after which deletion is acknowledged with a twice repeated acoustic signal,
- by switching the instrument off.

## 8.1 Transient Overvoltages

The multimeters are protected against transient overvoltages of up to 6 kV with a halftime value for front time of 1.2/50  $\mu$ s. Due to the fact that overvoltages of greater duration can be expected for measurements at transformers or motors etc., we recommend our KS30 measuring adapter. It provides protection against transient overvoltages of up to 6 kV with a halftime value for front time of 10/1000  $\mu$ s. Continuous loading capability is equal to 1200 V<sub>TRMS</sub>. Additional influence error due to use of the KS30 measuring adapter amounts to approximately  $-2\%$ .

## 8.2 Voltage Measurements for Greater than 600 V

Voltages of greater than 600 V can be measured with a high-voltage probe, e.g. the HV3 (3 kV) or the HV30 (30 kV DC) of GMC-I Gossen-Metrawatt GmbH. The earthing terminal must be connected to ground for measurements of this type. Observe all required safety precautions!

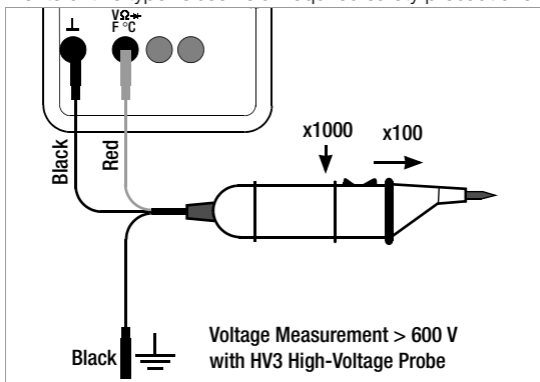

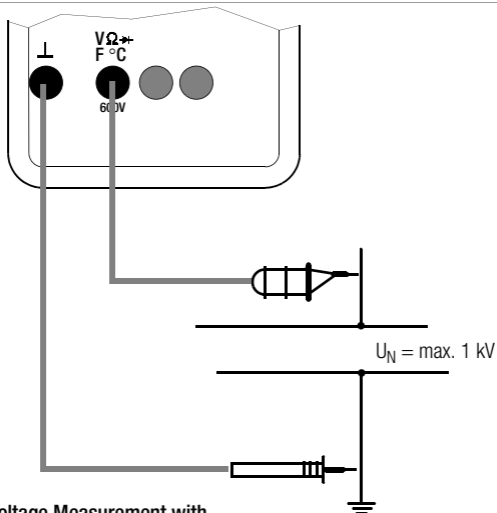

**Voltage Measurement with the KS30 Measuring Adapter**

### 8.3 Alternating Voltage Level Measurement (dB)

The voltage level measurement is used for determining the overall damping or gain of a transmission system (shown here as a two-port network).

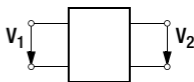

$$\text{Voltage level [dB]} = 20 \cdot \log \frac{V_2}{V_1}$$

with  $V_1 = V_{\text{REF}}$  (reference level  $rEF_{\text{VALUE}}$ )

result > 1: gain; result < 1: damping

⇒ Set the rotary switch to  $V \sim$ .

⇒ Briefly press the multifunction key ESC|FUNC.

The level measurement function is now active. The measurement value is calculated from the effective value of the alternating voltage component dependent upon the measuring range (300 mV ... 600 V), and is displayed. The default setting for the reference level is 0 dB = 0.775 V (1 mW at 600 Ω) and appears in the left hand sub-display. This value can be changed in the Setup menu:

SEt ↓ ▽  $rEF_{\text{VALUE}}$  ↓ ▽ unit dB ↓ XXX.XXX V/dB ▽ Δ ↓.



#### Note!

No matching resistors have been installed into the instrument. It takes measurements with a high input resistance of 5 MΩ. Input resistance for voltage measurement is listed under technical data. In order to perform correct measurements at non-terminated devices under test, a matching resistor must be connected to the terminals. Observe power dissipation at the matching resistor!

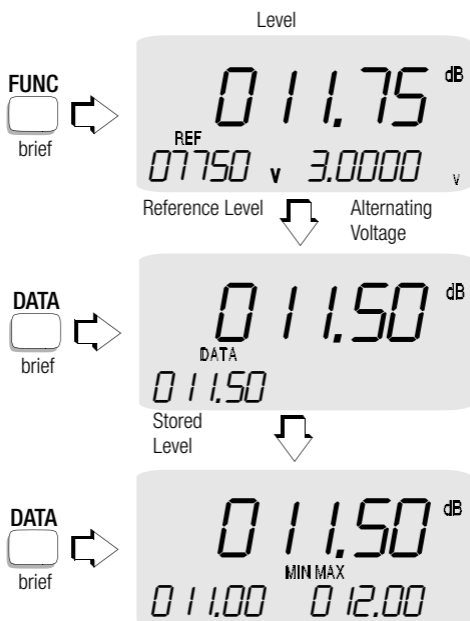

Alternating voltage applied to the jacks appears at the right hand sub-display.

- ⇨ The alternating voltage measuring range is selected with the MANIAUTO key.
- ⇨ The measurement value storage function for dB is made available by pressing the DATA/CLEAR key.
- ⇨ If the DATA/CLEAR key is pressed again, the normal display for dB with MIN/MAX values appears.
- ⇨ If the ESC/FUNC and MANIAUTO keys are pressed simultaneously, the actual measurement value becomes the reference value. The instrument returns to the first display with the measurement value as reference level.
- ⇨ If the ESC/FUNC multifunction key is activated repeatedly, the instrument is switched to frequency measurement, event measurement, voltage measurement and finally back to level measurement.

The dB ranges are listed under technical data.

## 9 Current Measurement

- ↪ First switch off the power supply to the measuring circuit or the load component and discharge any capacitors which might be present.
- ↪ Select range A  $\equiv$  with the rotary switch for currents  $> 300$  mA, or range mA  $\equiv$  for currents  $< 300$  mA. *Switch to the measuring range A first, for the measurement of currents of an unknown quantity.*
- ↪ Select the respective current type which corresponds to the measured quantity by briefly pressing the multifunction key ESCIFUNC. Each activation of the key causes alternate switching between DC and (DC + AC), as well as acknowledgement by means of an acoustic signal. The symbols DC and DC AC indicate the selected voltage type at the LCD display. After the range has been selected with the rotary switch, the DC current mode is always active. If the multifunction key ESCIFUNC is activated, the instrument switches to DC AC, which is acknowledged with an acoustic signal.
- ↪ Securely connect the instrument to the load component in series as shown (without matching resistor).

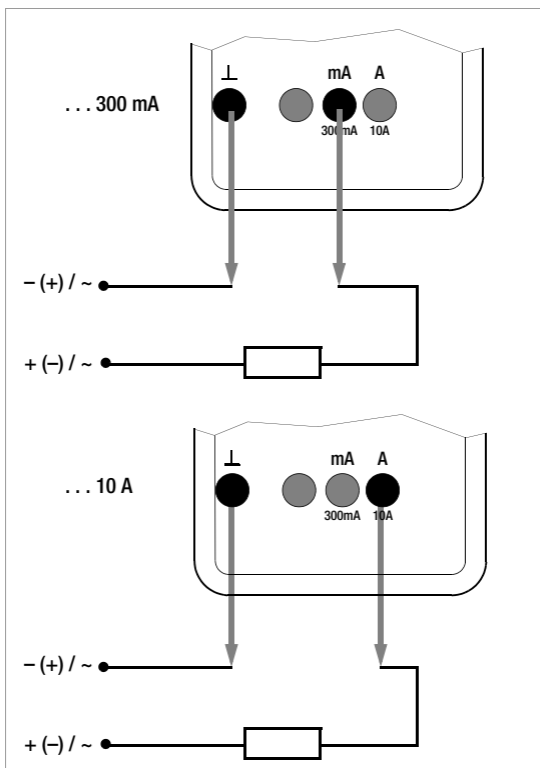

### Current Measurement Tips:

- The measuring circuit must be mechanically stable and protected against unintentional interruption. Conductor cross sections and connection points must be substantial enough to avoid excessive overheating.
- In the 300 mA and 10 A measuring ranges an intermittent acoustic signal warns you, if the measurement value has exceeded the measuring range upper limit value.
- Current ranges up to 300 mA are protected with a FF (UR) 1.6 A/1000 V AC/DC fuse in combination with power diodes up to a short-circuit current of 25 A. The breaking capacity of the fuse is equal to 10 kA at a nominal voltage of 1000 V AC/DC with resistive load.
- Measuring ranges up to 10 A are protected with a FF (UR) 10 A/1000 V AC/DC fuse. The breaking capacity of the fuse is equal to 30 kA at a nominal voltage of 1000 V AC/DC with resistive load.
- If one of the fuses has blown, "FUSE" appears at the LCD and an acoustic signal occurs simultaneously (when voltage has been applied).
- If a fuse blows, eliminate the cause of the overload before placing the instrument back into operation!
- Fuse replacement is described in Chapter 26.3, page 75.

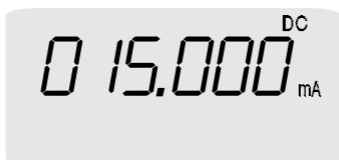

## 9.1 Measurement with (Clip-On) Current Transformers

### 9.1.1 Transformer Output mA or A for AC Measurements

If a (clip-on) current transformer is connected to the multi-meter (mA or A input), true values for all current and power displays are indicated in accordance with the selected transformation ratio. A current transformer with a transformation ratio of either 1000:1 or 10000:1 must be used, and the appropriate transformation ratio must be selected in the following menu.

### Current Clip Setup Menu:

SEt ↵ ▽ CLIP ↵ OFF ▽ 1000 ▽ 10000 ↵.

If a transformation ratio has been selected in the menu, and if the selector switch has been set for current or power measurement (range: mA AC or A AC), the current clip symbol appears at the display.



#### Attention!

If current transformers are used at the secondary side in an open condition, e.g. due to defective or non-connected power cables, a blown device fuse or incorrect connection, dangerously high voltages can occur at the terminals. For this reason, check to see if the measuring instrument's current path and transformer's secondary winding, which is connected to the instrument, complete a closed current circuit, and connect the transformer to the  $\perp$  and mA or A jacks.



#### Note!

After **measurement with the current clip has been completed**, "OFF" should be selected in the setup menu. Incorrect measurement values will otherwise result in the mA/A AC range, because the transformation ratio is still being taken into consideration.

The maximum allowable operating voltage is equal to the rated voltage of the current transformer. When reading the measurement value, also consider the additional display error.

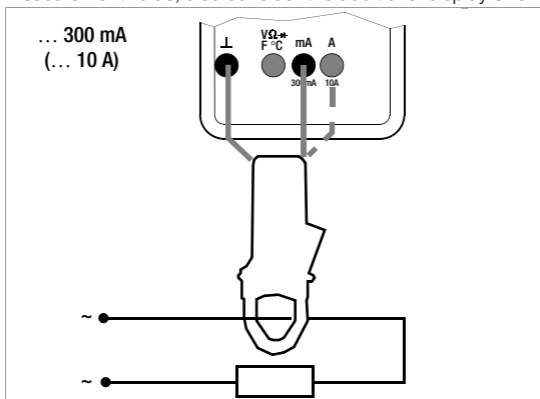

### 9.1.2 Transformer Output V for AC and DC Measurements

Some transformers have a voltage output (designation: mV/A). Consequently, the secondary terminal must be connected to  $\perp$  and V, and the instrument switched to voltage measurement.

The adjusted transformer factor „CLIP“ is disregarded in this case.

**Note:** Transformers with voltage output cannot be used for power measurement with the METRA HIT 29S !

## 10 Resistance Measurement

- ⇒ Be certain that the device under test is voltage-free.  
Extraneous voltages distort the measurement results!
- ⇒ Set the rotary switch to “ $\Omega$ ”.



0 15.000 k $\Omega$

- ⇒ Connect the DUT as shown.

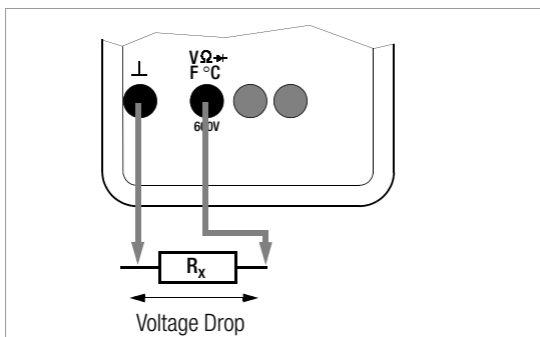

### Zero Balancing in the 300 $\Omega$ and 3 k $\Omega$ Measuring Ranges

Cable and transition resistance can be eliminated with zero balancing for measurements of small resistance values in the in 300  $\Omega$  and 3 k $\Omega$  ranges :

- ⇒ Connect the measurement cables to the instrument, and connect the free cable ends to one another.
- ⇒ Briefly press the multifunction key ESC|FUNC.  
The instrument acknowledges zero balancing with an acoustic signal and “000.000  $\Omega$ ” and the “ZERO” symbol appear at the LCD. The resistance which was measured at the moment the key was activated serves as a reference value (max. 20000 digits). It is automatically subtracted from subsequently measured values.

FUNC



brief



000.000  $\Omega$   
ZERO

- ⇒ Zero balancing can be deleted:
  - by pressing and holding the multifunction key ESC|FUNC, after which deletion is acknowledged with a twice repeated acoustic signal,
  - by switching the instrument off.

See chapter 11 for continuity testing.



## 11 Continuity Testing for Resistance Measurement

The instrument generates a continuous tone in a range from 0 ... approx. 10  $\Omega$  if the “acoustic signal” function is active, however only in measuring ranges from 0 ... 310  $\Omega$  (display, 3 $\frac{3}{4}$  places).

The trigger threshold can be adjusted in the Setup menu: SET  $\downarrow$   $\nabla$  trig  $\downarrow$   $\nabla$  cont in  $\Omega$   $\downarrow$  XXX  $\Omega$   $\nabla$   $\Delta$   $\downarrow$ .

### Activate continuity testing (acoustic signal ON):



#### Note!

The two measurement cables may not come into contact with one another when the multimeter is switched on, or prior to measurement function selection, as this would lead to zero point adjustment.

OL is displayed if the DUT is not connected.

- ⇒ Briefly press the multifunction key ESC|FUNC.  
Activation is acknowledged with an acoustic signal.  
The  symbol is simultaneously displayed at the LCD.



- ⇒ Connect the measurement cables to the DUT.

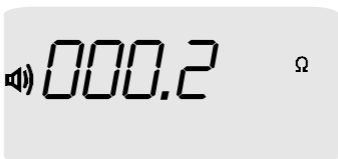

### Deactivate continuity testing (acoustic signal OFF):

- ⇒ Briefly press the multifunction key ESC|FUNC a second time.  
Deactivation is acknowledged with an acoustic signal.  
The  symbol disappears from the LCD.

After the “resistance measurement” function has been selected with the rotary switch, the continuity test or the acoustic signal is always deactivated.

## 12 Diode Testing

- Be certain that the device under test is voltage-free.  
Extraneous voltages distort the measurement results!
- Set the rotary switch to “ $\rightarrow +$ ”.
- Connect the DUT as shown.

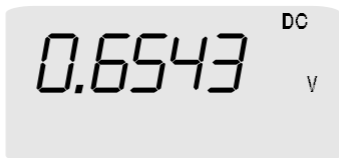

### Conducting Direction and Short-Circuit

The measuring instrument displays the forward voltage in volts. As long as the voltage drop does not exceed the maximum display value of 1.8 V, you can test several elements connected in series, or reference diodes with small reference voltages.

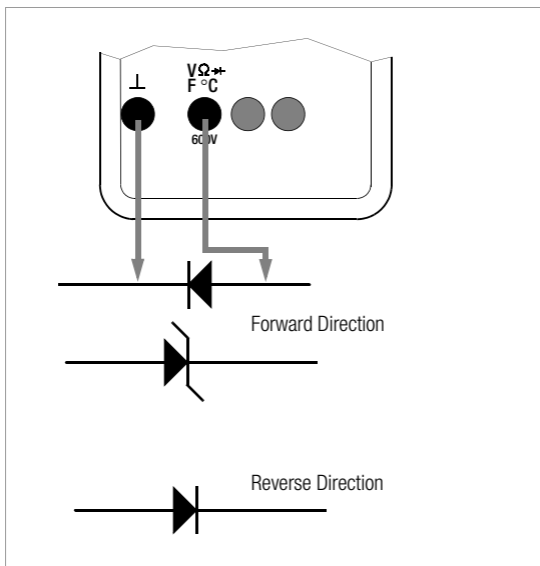

### Reverse Direction or Interruption

The measuring instrument indicates overflow “OL”.



#### Note!

Resistors and semiconductor paths connected in parallel to the diode distort measurement results!

See chapter 13 for continuity testing.

## 13 Continuity Testing for Diode Tests

The instrument generates a continuous tone in a range from 0 ... approx. 0.1 V if the “acoustic signal” function is active, however only in measuring ranges from 0 ... 310 mV (display, 3¾ places).

The trigger threshold can be adjusted in the Setup menu: SET ↵ ▽ triG ↵ ▽ cont in V ↵ XXX mV ▽△↵.

### Activate continuity testing (acoustic signal ON):

⇒ Briefly press the multifunction key ESC|FUNC.

Activation is acknowledged with an acoustic signal.

The 🔊 symbol is simultaneously displayed at the LCD.

OL is displayed if the DUT is not connected.



⇒ Connect the measurement cables to the DUT.

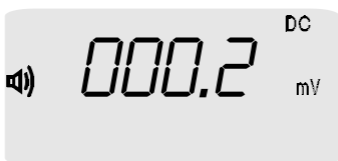

### Deactivate continuity testing (acoustic signal OFF):

⇒ Briefly press the multifunction key ESC|FUNC a second time.

Deactivation is acknowledged with an acoustic signal.

The 🔊 symbol disappears from the LCD.

After the “diode test” function has been selected with the rotary switch, the continuity test or the acoustic signal is always deactivated.

## 14 Capacitance Measurement

- ⇒ Be certain that the device under test is voltage-free.  
Extraneous voltages distort the measurement results!
- ⇒ Set the rotary switch to “F”.
- ⇒ Connect the (discharged!) DUT to the “⊥” and “F” jacks with measurement cables.



### Note!

For polarized capacitors, the “-” pole must be connected to the “⊥” jack.

Resistors and semiconductor paths connected in parallel to the capacitor distort measurement results!

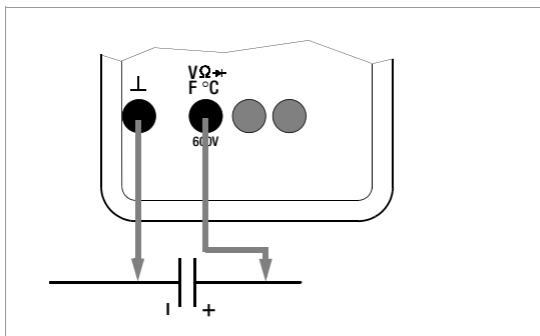

### Zero Balancing in the 3 nF and 30 nF Measuring Ranges

The inherent capacitance of the instrument and the capacitance of the cables can be eliminated with zero balancing for the measurement of small capacitive values in the 3 nF and 30 nF ranges:

- ⇒ Connect the measurement cables to the instrument without a DUT.
- ⇒ Briefly press the multifunction key ESCIFUNC.  
The instrument acknowledges zero balancing with an acoustic signal, and “0.000” and the “ZERO” symbol appear at the LCD. The capacitance which was measured at the moment the key was activated serves as a reference value (max. 200 digits). It is automatically subtracted from subsequently measured values.
- ⇒ Zero balancing can be deleted:
  - by pressing and holding the multifunction key ESCIFUNC, after which deletion is acknowledged with a twice repeated acoustic signal,
  - by switching the instrument off.

## 15 Frequency Measurement

The frequency measurement function can only be activated for voltage measurement in the  $V_{\sim}$  and the  $V_{\approx}$  mode.



### Note!

It is advisable to measure frequency with the selector switch in the  $V_{\sim}$  position. Frequency measurement may be distorted by a superimposed DC component in the  $V_{\approx}$  position.

- Set the rotary switch to  $V_{\sim}$  or  $V_{\approx}$ .
- Apply the measured quantity in the same fashion as for voltage measurement.
- Select the measuring range for the voltage amplitude.
- Repeatedly press the multifunction key ESCIFUNC until Hz appears in the display (for  $V_{\sim}$  twice, for  $V_{\approx}$  once). The instrument switches to frequency measurement. Frequency is read out to the main display, and voltage amplitude to the left hand sub-display. The frequency measuring range can be selected subsequently. The lowest measurable frequencies and maximum allowable voltages can be found in Chapter 25 „Characteristic Values“.
- From the frequency measurement mode, you can switch directly back to voltage measurement by pressing and holding the multifunction key ESCIFUNC, which is acknowledged with a twice repeated acoustic signal. The last selected voltage measuring range remains active.

Selector Switch Position  $V_{\sim}$

Frequency



2 x FUNC



brief



Voltage  
Amplitude

Selector Switch Position  $V_{\approx}$

Frequency



FUNC



brief



Voltage  
Amplitude

## 16 Temperature Measurement

- ⇒ The temperature unit of measure can also be changed in the Setup menu:

SEt ↵ tEMP<sub>SEnSor</sub> ↵ ... ↵ tEMP<sub>unit</sub> ↵ °C ▽ °F ↵

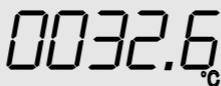

0032.6 °C

### 16.1 Temperature Measurement with Pt100 and Pt1000

- ⇒ The type of sensor used (e.g. Pt100 or Pt1000) as well as cable resistance, must be entered in the Setup menu:

SEt ↵ ▽ tEMP<sub>SEnSor</sub> ↵ ▽ Pt 100 ↵  
XX.X Ω ▽ Δ ↵

- ⇒ Set the rotary switch to “°C”.
- ⇒ Connect the sensor to the two open connector jacks. The instrument displays the measured temperature in the desired unit of measure.

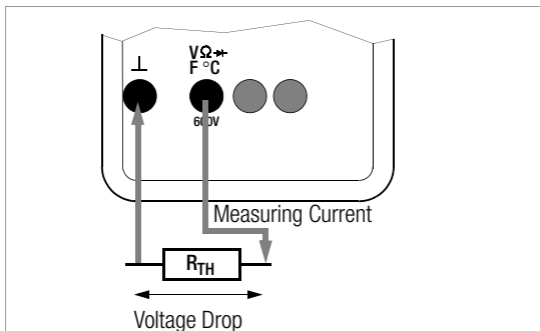

#### Note!

The cable resistance entered in the Setup menu is automatically taken into consideration for this measurement.

The default setting is 0.1 Ω.

### 16.2 Temperature Measurement with Thermocouple and Reference Junction

- ⇒ Enter the type of sensor to be used (J or K) in the “Setup” menu:

SEt ↵ ▽ tEMP<sub>SEnSor</sub> ↵ ▽ Δ J/K ↵ ...

The reference temperature can be measured either with the internal or an external reference junction, or it can be assigned a fixed value in the Setup menu.

### Enter sensor type and select internal reference temperature:

SEt ↓ ▽ tEMP<sub>SEnSor</sub> ↓ ▽ Δ J/K ↓ E=tern ▽ intErn ↓

### Enter sensor type and select external reference temperature:

SEt ↓ ▽ tEMP<sub>SEnSor</sub> ↓ ▽ Δ J/K ↓ E=tern ↓

XX.XXXX °C ▽ Δ ↓

- ⇒ Set the rotary switch to “°C”.
- ⇒ Connect the sensor to the two open jacks. The instrument displays the measured temperature in the desired unit of measure.



#### Note!

The internal reference temperature (internal reference junction temperature) is measured with a temperature sensor in close proximity to the input jacks. It is somewhat higher than room temperature due to internal warming. The extent of this deviation has no influence on measuring accuracy.

### Temperature Menu

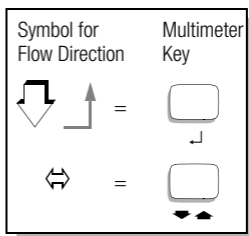
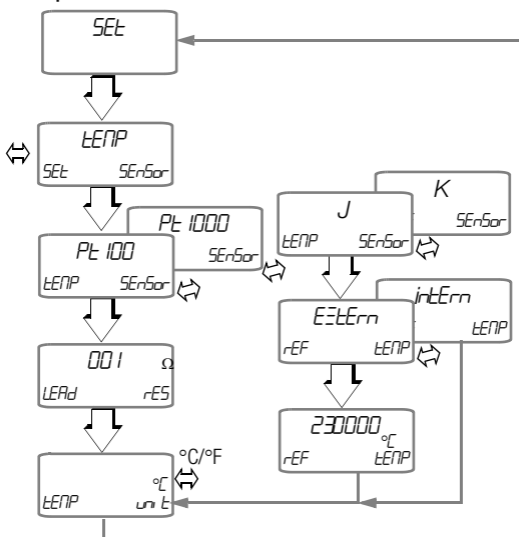

## 17 Counting Events and Zero Crossings

These functions can be activated in the V $\approx$  and V $\sim$  rotary switch positions.



### Note!

*Automatic shut-off is not active in this functional mode.*

### 17.1 Event Counting

The following can be measured and displayed:

- Number of events

*An event is counted if the measurement value lies below the lower threshold L-trig for at least 1 second, **and** subsequently for at least 1 second above the upper threshold H-trig. Voltage signals with a repetition frequency of maximum 0.5 Hz are recorded (minimum period: 2 seconds).*

- Total time of all events

*Time, during which the measured voltage was above the upper threshold.*

- Overall time since start of event counting.

➤ First enter the upper and lower thresholds as digits (see examples in the table below, as well as Chapter 23 „Setting the Measurement Parameters“):

SEt ↵ ▽ triG ↵ ▽ EVENTS ↵

H-triG ↵ XXXXXX ▽ Δ ↵

L-triG XXXXXX ▽ Δ ↵.

➤ Set the rotary switch to V $\approx$  or V $\sim$ .

➤ Manually select the measuring range for event counting.

➤ Apply the signal in the same fashion as for voltage measurement.

➤ Repeatedly press the multifunction key ESC|FUNC until EVENTS appears at the display.

### Example Entries for Trigger Thresholds

Measuring Range	Value: trigger threshold H-trig or L-trig in digits		
	200 000 <sup>1)</sup>	020 000	002 000
Measuring Range	Effective Trigger Threshold		
300 mV	200 mV	20 mV	2 mV
3 V	2 V	200 mV	20 mV
30 V	20 V	2 V	200 mV
300 V	200 V	20 V	2 V
600 V	<sup>2)</sup>	200 V	20 V



<sup>1)</sup> Values of up to 300 000 digits (for H-trig) are reasonable for measuring ranges from 300 mV to 300 V.

<sup>2)</sup> Values of up to 60 000 digits (for H-trig) are reasonable for the 600 V measuring range, because a trigger threshold of 600 V results from this maximum value, which corresponds with the measuring range upper limit.

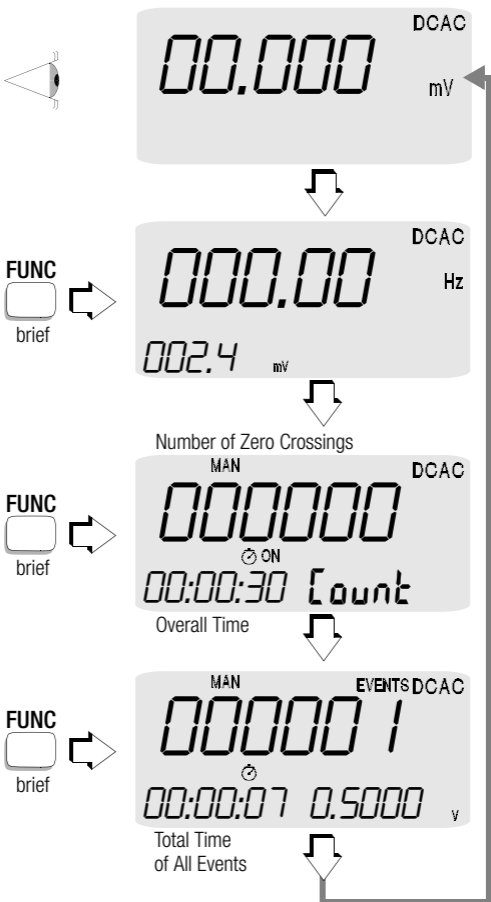



You can switch between two different time displays with the MAN/AUTO key:

-  Overall time as of start of events measurement
-  ON Total time of all events (voltage above H-triG)



The DATA/CLEAR key has no function in this case.

Recorded events are automatically deleted by switching to voltage measurement with the ESC/FUNC key.

## 17.2 Count Zero Crossings

This function counts and displays the number of times the input signal passes through zero.

Counting can be stopped or restarted with the help of the MANIAUTO key. Status is indicated with the following display:

-  **ON**    Counting activated
-         Counting stopped

By briefly activating the DATA|CLEAR key, the current value from the main display is entered to the sub-display and stored to memory. The clock symbol disappears and DATA is displayed.

By pressing and holding the DATA|CLEAR key, both displays are deleted, and the original time measurement function is restored to the sub-display.

## 18 Stopwatch

Time periods of up to one hour can be measured with this function.

- Set the rotary switch to “V  $\equiv$ ”
- Select a measuring range between 3 V and 600 V with the MANIAUTO key.



### Note!

This function cannot be activated in the 300 mV  $\equiv$  measuring range!

---

- Press and hold the ESC|FUNC key. The clock is reset, and “00:00.00” and the  clock symbol are displayed at the LCD.
- The clock can be started and stopped by pressing the MANIAUTO key. Minutes, seconds and tenths of seconds are displayed in digital form.
- By pressing the DATA|CLEAR key, intermediate time is captured in the left hand sub-display.
- Repeated activation of the DATA|CLEAR key moves the last recorded intermediate time into the right hand sub-display, and updates intermediate time in the left hand sub-display at the same time.
- Pressing the MANIAUTO key stops the clock.
- If the multifunction key ESC|FUNC is pressed once, or if the rotary switch is activated, the stopwatch function is exited.

### Activate Stopwatch

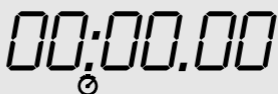
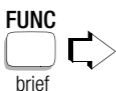

### Start Stopwatch

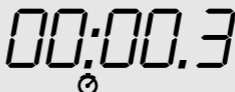
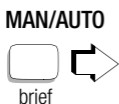

### Capture Intermediate Time

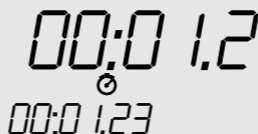

### Update Intermediate Time

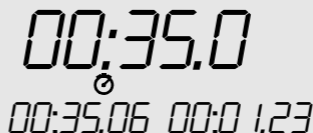

### Stop the Clock



### Reset Stopwatch / Exit Function

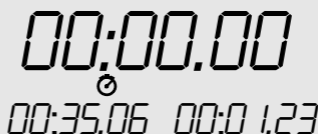

## 19 $\Delta$ Operating Mode, Reference Value REF

The delta operating mode allows for the display of referenced values. Normalized reference values are automatically correlated to a previously selected reference value, i.e. the reference value is subtracted from the current measurement value.

An individual reference value must be entered in the "Setup" menu for each of the y measurement functions: V, A,  $\Omega$ ,  $\mu\text{F}$ , Hz and  $^{\circ}\text{C}$ .

- Select the reference value for the corresponding measurement function in the Setup menu:  
SEt  $\downarrow$   $\nabla$  rEF<sub>VALUE</sub>  $\downarrow$   $\nabla$  unit x  $\downarrow$  XXXXXX y  $\nabla$   $\Delta$   $\downarrow$ .
- Select the measuring range manually.
- In order to enter the  $\Delta$  operating mode, simultaneously press the ESC|FUNC and MAN|AUTO keys.

The current measurement value is then displayed, normalized in reference to the stored reference value.

Alternatively, a measurement value can be assigned as a reference value by briefly pressing the ESC|FUNC and the MAN|AUTO keys simultaneously in the  $\Delta$  mode. This reference value remains active until the above described operation is repeated (MAN|AUTO), or until the  $\Delta$  mode is exited. After exiting and re-initializing the  $\Delta$  mode, the reference value selected in the setup menu is active.

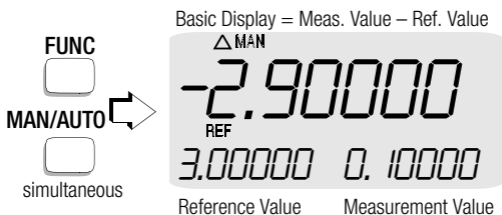

- Exit the  $\Delta$  operating mode by pressing and holding the ESC|FUNC key.

## Example for the Entry of Reference Values

	Value: reference value in digits		
	200 000 <sup>1)</sup>	020 000	002 000
Measuring Range	Effective Reference Value		
300 mV	200 mV	20 mV	2 mV
3 V	2 V	200 mV	20 mV
30 V	20 V	2 V	200 mV
300 V	200 V	20 V	2 V
600 V	<sup>2)</sup>	200 V	20 V

- <sup>1)</sup> Values of up to 300 000 digits are reasonable for measuring ranges from 300 mV to 300 V.
- <sup>2)</sup> Values of up to 60000 digits are reasonable for the 600 V measuring range, because this maximum value results in a reference value of 600 V, which corresponds to the measuring range upper limit.

## 20 Power Measurement with the METRA HIT 29S

### 20.1 Power Measurement with Analog Signals I and V

The METRA HIT 29S is a compact power meter for direct and alternating current for single phase power measurement. The current path can be measured directly (up to 10 A) or with the help of a (clip-on) current transformer. Universal power measurement includes the following measurement functions: active, reactive and apparent power, power factor, energy, mean and maximum power values.

- Select power measurement with analog signals in the EnErGY menu by setting the following parameters: unit of measure W, VA or VAR for mean and maximum values as well as the corresponding integral-action time (see chapter 20.3).
- Set the rotary switch to “W/mA” (max. 300 mA) or “W/A” (max. 10 A), see page 70.
- Briefly press the ESCIFUNC key.  
Measurement is switched from A DC to A DC and AC.
- Press the ESCIFUNC key a second time to start active power measurement.

Each additional activation of the ESCIFUNC key causes switching to the various display functions for active power  $W$ , apparent power  $VA$ , reactive power  $VAR$ , energy  $Wh$ , mean value  $MEAN W$  and maximum power values  $MAX VA$  and  $W$ .

- Connect current and voltage paths as shown below.  
Connect either the mA or the A output, depending upon the previously selected switch position. See Chapter 20.5, page 42 for use with **current transformers**.

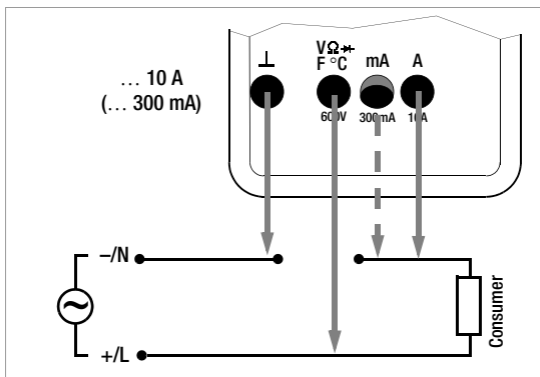

The instrument automatically selects the measuring range which provides maximum resolution for the current measured quantity.

#### Significance of Power Factor Display

- $\pm 1$ : no phase displacement
- $-(0 \dots 0.99)$ : capacitive
- $+(0 \dots 0.99)$ : inductive

## Power Measurement with Analog Signals

Active Power (+ = Import, - = Export)

FUNC



2 x brief

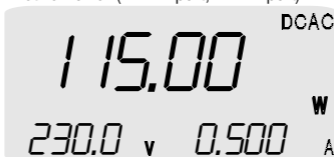

Apparent Power

FUNC



brief

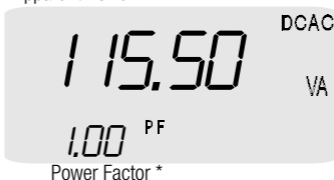

Reactive Power

FUNC



brief

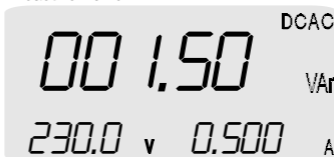

Energy (active power per measured time period)

FUNC



brief

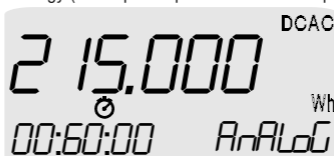

Elapsed time since start of energy measurement

Mean value during integral-action time, see EnErGY

FUNC



brief



Elapsed time since start of a new time interval

e.g. 15 minutes maximum, see EnErGY

FUNC



brief



\* If measurement value < 1% of smallest measuring range PF = ---

## 20.2 Energy Measurement with Pulses

- Set the triG cont in parameter in the EVENTS counter for example at 999 mV, see chapter 22.2.1.
  - Select energy measurement with pulses in the EnErGY menu by setting the following parameters:
    - 3 V measuring range:** The internal power source of the multi-meter (1 mA/max. 3 V) leads to a measured signal level  $Low < Value\ triG\ cont$  in if there is a short circuit in the measuring circuit. This trigger level is exceeded again when the measuring circuit is open. The pulse signals can thus be generated via a switching contact.
    - 30 V measuring range (for S0 pulse):** The internal power source is deactivated in this setting. For the active voltage pulses which are connected (e.g. 0/24 V  $\square$ ) the same trigger level triG cont in applies for High/Low detection.
    - Other parameters to be configured:** pulse/kWh ratio, unit of measure W, VA or VAR for mean and maximum values as well as the corresponding integral-action time (see chapter 20.3).
  - Set the selector switch to “ $\rightarrow$ ”.
  - Press the ESCIFUNC key twice.
    - Active power measurement has now been activated.
- Each additional activation of the ESCIFUNC key causes switching to the various display functions for energy *Wh*, mean value *MEAN VA* or *W*, and maximum power values *MAX VA* and *W*.
- Connect the pulse output (for example from a meter) to the “ $\perp$ ” and “V” jacks.







### Note!

The functions MAN/AUTO, ZERO, MIN/MAX and  $\Delta$  are not active for power/energy measurement.  
When Wh appears at the display, the measured energy values can be deleted by pressing and holding the DATA/CLEAR key.

## 20.3 EnERGY Menu for Energy Measurement

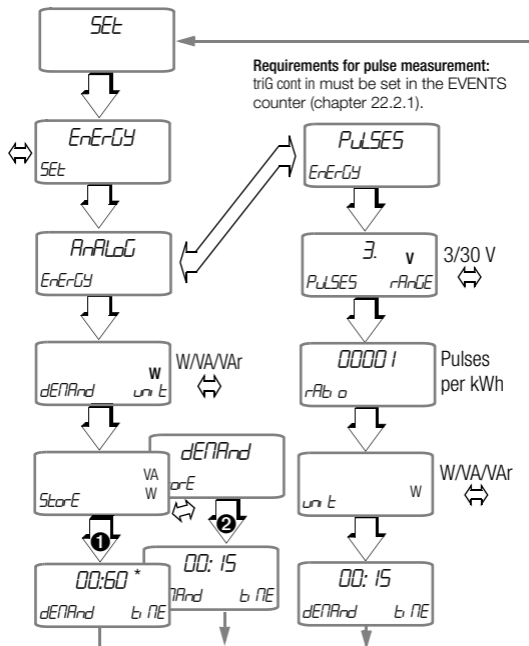

\* No function

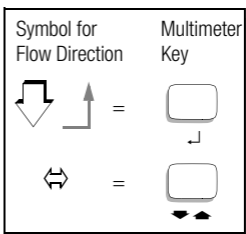

- 1 In memory mode, measurement values for P [W], I [A] and V [V] are always stored to memory at the selected rATE independent of displayed power quantities (see Chapter 23.1.3, page 58).
- 2 In memory mode, only the mean value generated at the interval selected under dEMANd tiME [in hh:mm] for the selected power quantity, dEMANd unit [W/VA/VAr], is stored to memory at the end of each interval.

## 20.4 Exit Power/Energy Measurement

The power/energy measurement mode is exited by pressing and holding the ESCIFUNC key.



### Note!

Automatic shut-off is disabled in the power measurement mode.

## 20.5 Power Measurement with (Clip-On) Current Transformers

Only current transformers with mA or A output can be used. Since DC current clips are only equipped with one voltage output, measurement of DC power with clips is not possible.

Chapter 9.1.1, page 22, contains information for taking transformation ratios into consideration.

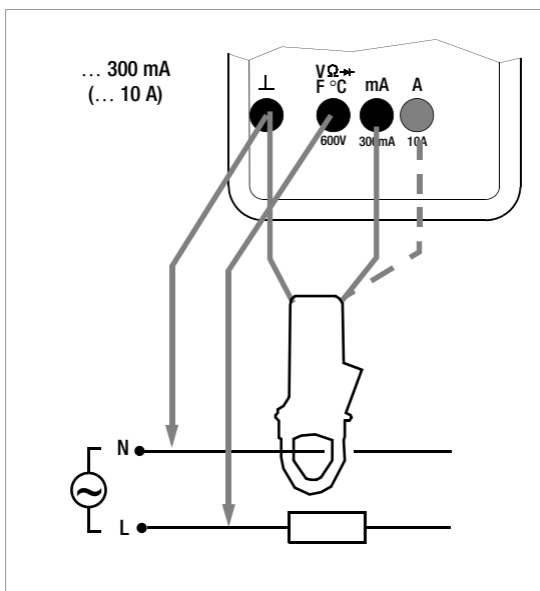

### 21.1 Line Fault Recording without Memory Mode

The measuring instrument provides for the continuous logging of line voltages and line faults. The following line faults can be recorded: violation of predetermined upper and lower limit values (LO, HI), mains failure (drop out) and positive and negative pulses (+/-pulses). Each of these events is stored to intermediate memory and can be subsequently queried. The type of event, the time of occurrence and duration (except for pulses) are displayed.

Events remain in intermediate memory until the line fault recording mode is exited. Approximately 250 events can be stored to volatile memory without activating the memory mode.

These events can be stored at the instrument as a compressed data file in the memory mode (see chapter 21.3), and can be uploaded to a PC later.

- The limit values must be entered in the setup menu before measurement is started, if these have not already been set (see chapter 23).
- Set the rotary switch to “V  $\approx$ ”.
- Repeatedly press the ESCIFUNC key until StorEd is displayed (immediately follows EVENTS display).
- Basic Display: As soon as the multimeter records an event, the type of fault is first read out to the sub-display, which is followed by the display: “StorEd”. At the same time, the consecutive number assigned to the stored event appears in the right hand sub-display. This number represents the total number of stored events.
- Display 1: You can scroll from one stored event to the next with the  $\nabla$  (previous events) and  $\Delta$  (recent events) keys (right hand sub-display). The type of line fault appears at the main display, and time of occurrence appears at the left hand sub-display (with clock symbol). Display 1 is exited by activating the ESCIFUNC key, upon which the basic display reappears.



#### Note!

The multimeter continues recording new events, even when you scroll through previously stored events. If two events occur simultaneously, only one is displayed, although both are correctly stored.

---



Basic Display: current measurement value and number of registered events

FUNC



brief

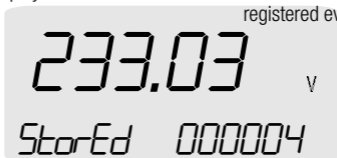

Event 4: lower limit violation



Event 3: upper limit violation

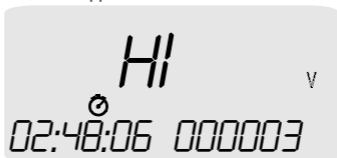

Event 2: drop out

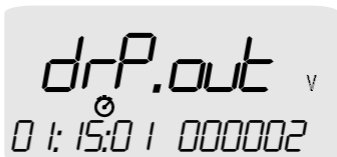

Event 1: pulse or short duration peak

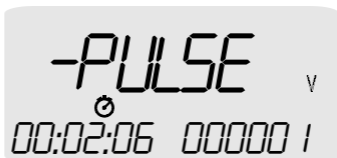

Esc

- ⇨ Display 2: After an event has been selected (Display 1) and acknowledged with the ENTER key, the event amplitude appears at the main display, and the duration of the event appears in the left hand sub-display. If drop out occurs, no voltage value can be queried. The clock symbol and ON are displayed. Scrolling is also possible in Display 2 with the  $\nabla/\Delta$  keys. Display 2 is exited by pressing the ESC/FUNC key and the instrument is returned to the basic display.

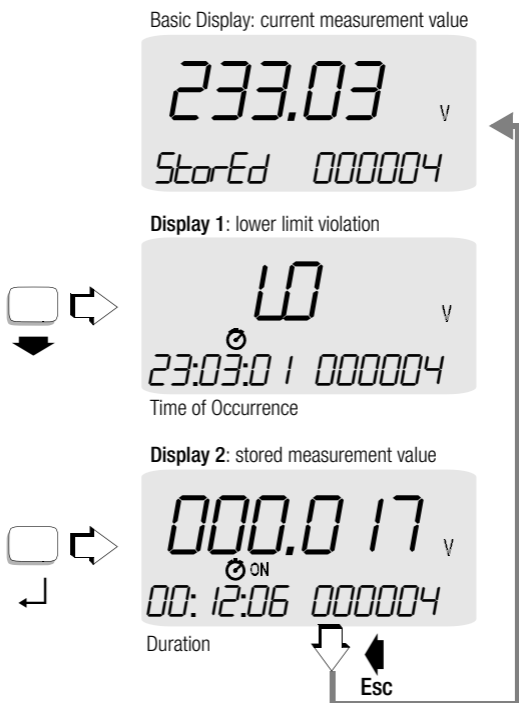

#### Note!

The functions ZERO, DATA, MIN, MAX and DELTA are disabled in the line fault recording mode.

### Deleting Events

All stored events can be deleted by simultaneously activating the MANIAUTO and DATA/CLEAR keys.

## Exiting the Line Fault Recording Mode

- ↪ The line fault recording mode is exited by pressing and holding the ESCIFUNC key.



### Note!

Automatic shut-off is disabled in the line fault recording mode.

## 21.2 Trigger Parameters for Line Fault Recording

An overview (flow chart) of the complete trigger menu can be found on page 54.

### Mains Failure Measuring Range: *MAinS rAnGE*

A measuring range of either 300 V or 600 V can be entered here for line fault recording.

SEt ↵ ▾ triG ↵ ▾ MAinS ↵ rAnGE: 300/600 V ▾ △ ↵

### Trigger Thresholds *H-triG* and *L-triG*

Measuring function V for line fault recording requires its own upper and lower thresholds for triggering purposes. The upper limit should always be greater than the respective lower limit.

Entering upper and lower thresholds in digits:

SEt ↵ ▾ triG ↵ ▾ MAinS ↵ rAnGE: XXXX V ↵ e.g. 600 V

H-triG: XXXXXX ▾ △ ↵ e.g. 250000 = 250.00 V

L-triG: XXXXXX ▾ △ ↵ e.g. 190000 = 190.00 V

Examples for the entry of trigger thresholds in digits can be found in the table in Chapter 17.1, page 32.

### Drop Out Trigger Level: *triG drPout*

A level with a value ranging from 0 V and 600 V can be selected here in 10 V steps for the mean value of the voltage measurement for the respective time period.

SEt ↵ ▾ triG ↵ ▾ MAinS ↵ rAnGE: XXXX V ↵

H-triG: XXXXXX ↵

L-triG: XXXXXX ↵

triG drPout: 0 ... 600 V ▾ △ ↵

### Pulse Trigger: *triG PULSE*

A trigger level can be selected here as an absolute value for transient voltages which are superimposed upon the line voltage.

SEt ↵ ▾ triG ↵ ▾ MAinS ↵ rAnGE: XXXX V ↵

H-triG: XXXXXX ↵

L-triG: XXXXXX ↵

triG drPout: XXXX V ↵

triG PULSE: amplitudes from 200 to 600 V ▾ △ ↵

### 21.3 Line Fault Recording with Memory Mode

A much greater number of events can be stored to memory if the memory mode is activated. See chapter 22.

**Measurement values resulting from the following measuring functions are stored to memory:**

- Line voltage V AC+DC TRMS (sampling rate: 500 ms). Measuring voltage is stored together with trigger and hysteresis settings.
- Drop outs (sampling rate: 20 ms) are stored as a curve with 10 ms interpolation points for a maximum duration of 1 s. The last 10 values which occur before triggering, "drPout", remain in memory.
- Voltage peaks (pulses) are stored to memory if the "PULSE" trigger threshold is exceeded.
- Simultaneously occurring events are stored to a special main memory (max. 250 events).

## 22 Storing Measurement Values with the METRA HIT 29S

The instrument is equipped with a quartz movement synchronized measurement value memory (128 kB), which holds an average of 50,000 measurement values. Minimum capacity is 20,000 values (if large signal deviations or time spans occur between the measurement values). Maximum capacity is 100,000 measurement values (minimal signal deviation, rate  $\geq 0.5$  s, hysteresis = „ALL“). The measurement data are stored as so-called data blocks. Measurement values from the same measuring function are stored in the same block. Data are acquired relative to real-time. Thus the instrument may also be used as a real-time data logger.

Only absolute values and absolute time records can be stored (no relative or  $\Delta$  values, and no relative time records). Memory content can only be read out with the help of a PC, an infrared adapter and METRAWin<sup>®</sup>10/ METRAHit<sup>®</sup> analysis software.

### Preparations for Memory Mode Operation



#### Note!

First set **hysteresis**, **sampling rate** and **triggering parameters** for memory mode operation, and then activate the memory mode. These parameters cannot be changed during operation in the memory mode, or the transmission mode.

- ⇒ Select the desired measuring function, as well as an appropriate measuring range. In the automatic measuring range selection mode measuring breaks and/or overflow „OL“ may occur when switching between the measuring ranges. We therefore recommend the manual range selection mode when using the memory function.
- ⇒ Check the charging level of the battery before starting long-term measurement value recording (see Chapter 26.1, page 74). Connect the AC power pack if necessary.

## Starting Memory Mode Operation via Menu Functions

- ⇒ Enter the “Menu Mode” (see Chapter 23, page 56).
- ⇒ Select the main menu: StorE.
- ⇒ The memory mode is started by activating the ↵ key. Current memory occupancy is displayed as a percentage. It may range from 00.00 to 99.99%.
- ⇒ In order to return to the measuring function, press the ESCIFUNC key twice. MEM appears at the display.

## Starting Memory Mode Operation via Shortcut

- ⇒ Simultaneously activate the ESCIFUNC and ON keys. MEM appears at the display.



### Note!

The memory mode is not aborted by selecting another measuring function with the rotary switch or the ESCIFUNC key, however, a new recording is started (a new memory block is generated). If the sampling interval is 10 s or greater, the display is shut down in order to extend battery service life.

---

## MEM Display

The MEM symbol indicates that the memory mode has been activated. Individual storage events such as the storage of measurement values are indicated by a brief disappearance of the MEM display. As long as the storage rate is less than 1 s, MEM blinks once per second.

## TRIG Display

The TRIG symbol indicates that a “trigger event” has occurred. A blinking TRIG symbol indicates that the trigger has been activated, and that it is waiting for a trigger event to occur.

## SAMPLE Operating Mode

If the sampling rate has been set to “SAMPLE” (see chapter 23.1.1), individual measurement values for the selected measuring function can be manually stored to memory.

- ⇒ Press the ESCIFUNC and ON keys simultaneously to save the current measurement value.

## DATA Operating Mode

Proceed as follows in order to store data to memory with the “DATA” function:

- ⇒ Set the sampling rate to “DATA” (see chapter 23.1.1) and the hysteresis to „ ALL“ (see chapter 22.1).
- ⇒ Enter memory mode operation.
- ⇒ Activate the DATA|CLEAR key and the measurement values are stored to memory with the “DATA” function, i.e. after the measuring signal has been applied and the display has settled to a stable value (see chapter 5).



Menu Mode



Main Menu: Store



Current Memory Occupancy

MEM



ESC

StorE 00.00

2x



ESC

MEM

DC



mV

### High Speed Storage Rate – Rapid Sampling

The following conditions prevail (for V DC) as long as the storage rate is less than 50 ms:

- 888888 appears continuously at the main display,
- the decimal point is fixed: automatic measuring range selection is disabled,
- “StorE buSY” appears at the sub-displays,
- each measurement value is stored to memory (trigger and hysteresis are not active),
- Toroidal core memory mode is deactivated ( $CYCLE_{rAM} = OFF$ ; see chapter 22.1)

### Memory Occupancy Query: *OCCUP*

Memory occupancy can be queried from the INFO menu. Occupancy is read out to the main display in % from 00.00% to 99.99%.

SEt ▾ inFo ↵ tiME ▾ bAtt ▾ tEst<sub>rAM</sub> ▾ OCCUP ↵

### Exiting the Memory Mode via Menu Functions

- ↗ Select the main menu: StorE.
- ↗ Activate the ↵ key. Memory occupancy is displayed.
- ↗ Activate the ↵ key again, and StOP appears at the display.
- ↗ Activate the ↵ key once again, and the setup display returns to SEt. MEM disappears. The memory mode is deactivated.
- ↗ Press ESCIFUNC to return to the measuring function.

### Exiting the Memory Mode via Shortcut

- ↗ Simultaneously activate the ESCIFUNC and ON keys.

### *rAM*<sub>CLEAR</sub> – Delete Memory

---



#### Attention!

This function deletes all measurement values which have been saved to memory.

---

The entire RAM can be cleared which contains, for example, power disturbance data:

SEt ▾ rAM ↵ no ▾ YES ↵

## 22.1 General Parameters

### Memory Duration: *durA*

This parameter allows for a determination as to whether or not measurement values should only be stored for a limited amount of time. If memory duration is activated (on), a period of time during which data are to remain in storage can be entered in days and hours.

SEt ↵ ▾ durA ↵ OFF ▾ on ↵

0–9 (dAYS) ▾ Δ ↵ 00:00:00 (tiME) ↵

### Toroidal Core Memory Mode: *CYCLE*<sub>rAM</sub>

If the toroidal core memory mode has been selected – *CYCLE*<sub>rAM</sub> “on” – the oldest value is deleted and overwritten with the new value when memory overflow occurs.

If *CYCLE*<sub>rAM</sub> is set to “OFF”, the memory mode is deactivated as soon as the memory is full.

The toroidal core memory mode cannot be activated if rapid sampling has been selected (0.5 ms to 20 ms). The selected setting is always perceived as “OFF”.

SEt ↵ ▾ durA ↵ ▾ OFF ↵ *CYCLE*<sub>rAM</sub> ↵ OFF ▾ on ↵

## Hysteresis: *HYS*t

The hysteresis setting allows for efficient memory utilization.

In the memory mode, new measurement data are only stored as a data block if they deviate from the previously stored value by an amount which is greater than the selected hysteresis.

Hysteresis can be set in steps of 1, 2 or 5 digits. These digits make reference to the measuring range as follows: The positions of the digits in the pre-selected hysteresis correspond to the same positions within the measuring range, but are counted starting at the left.

**Example:** A pre-selected hysteresis of 001000 for the 300,000 V measuring range means that only those measurement values which deviate from the previous measurement value by at least 001.000 V are stored.

All measurement values are stored to memory if hysteresis is set to "ALL". This may be required, for example, for real-time analysis at a PC with simultaneous display at the monitor.

- See chapter 23 for entering the "Operating Mode Menu".
- Enter hysteresis as follows:  
SEt ↵ ▽ HYS t ↵ 000500 △ ▽ ↵

## 22.2 Trigger Functions

With the help of the trigger functions (except for trigger events, trigger cont in and mains trig hi, lo), you can determine which measurement values are stored to memory. In the following examples for the selection of parameters, V represents trigger variables V, A,  $\Omega$ , °C,  $\mu$ F, Hz, dB and W. Furthermore, the trigger function **in** represents **in**, **out**, **Sto<sup>-</sup>ou** and **Sto<sup>-</sup>in**. An overview (flow chart) of the complete trigger menu can be found in page 54.



### Note!

Changing the measuring function has no influence on the trigger functions. The following trigger parameters are not active if the sampling rate is less than (faster than) 50 ms.

---

### triG = OFF

If the triG function is set to OFF, measurement values can be stored to memory independent of quantity (independent of parameters H-triG, L-triG, prEtr and rEtriG). However, storage is dependent upon date and time trigger parameters.

SEt ↵ ▽ triG ↵ V ↵ ▽ △ OFF ↵ tiMEon ...

### **triG = out**

Measurement values are stored if at least one measurement value occurs which lies within the limits for H-triG and L-triG, and if one of the two limit values is violated thereafter.

SEt ↵ ▽ triG ↵ V ↵ ▽ Δ out ↵ H-triG ...

### **triG = in**

Measurement values are stored to memory if the following conditions are met: at least one measurement value occurs which lies outside of the limits for H-triG or L-triG, and if one of the two limit values is again violated thereafter.

SEt ↵ ▽ triG ↵ V ↵ ▽ Δ in ↵ H-triG ...

### **triG = Sto<sup>-</sup>ou**

Only those measurement values are stored to memory, which do not lie within the limits for H-triG and L-triG.

SEt ↵ ▽ triG ↵ V ↵ ▽ Δ **Sto<sup>-</sup>ou** ↵ H-triG ...

### **triG = Sto<sup>-</sup>in**

Only those measurement values are stored to memory, which do lie within the limits for H-triG and L-triG.

SEt ↵ ▽ triG ↵ V ↵ ▽ Δ **Sto<sup>-</sup>in** ↵ H-triG ...

## **22.2.1 Trigger Function Parameters**

### **Upper Limit *H-triG*, Lower Limit *L-triG***

Each trigger function is assigned its own upper and lower limits as trigger parameters. The upper limit should be greater than the respective lower limit.

The predetermined trigger threshold is evaluated according to the selected measuring range, independent of whether or not automatic measuring range selection is activated.

Entering upper and lower trigger thresholds in digits:

SEt ↵ ▽ triG ↵ V ↵ in

**H-triG** ↵ XXXXXX ▽ Δ ↵

**L-triG** XXXXXX ▽ Δ ↵.

---

### **Note!**

Values for H-triG and L-triG are also used as trigger parameters for cont in, events or mains. The table in chapter 17.1 contains examples for the entry of trigger thresholds in digits.

---

### **Pre-Trigger: *PrEtr***

If this function has been activated (on), measurement values are stored to memory immediately after the memory mode has been activated dependent upon the time trigger (see below). If this function has been deactivated (OFF), only those measurement values which exceed the trigger threshold are stored to memory when the memory mode is activated.

SEt ↵ ▽ triG ↵ ▽ MAinS ↵ rAnGE: XXXX V ↵

H-triG: XXXXXX ↵

L-triG: XXXXXX ↵  
triG drPout: XXXX V ↵  
triG PULSE: XXXX V ↵  
PrEtr: OFF/on ▽△↵

---



**Note!**

The pre-trigger can only be activated, if trig=in or trig=out has been selected.  
We recommend the entry of a defined memory duration prior to activation of the pre-trigger, (see "Memory Duration: durA" on page 50).

---

**Re-Trigger rEtriG**

After a trigger signal and storage to memory have occurred – memory duration durA has expired – the trigger is reset. The re-trigger function remains disabled as long as the pre-trigger function is active.

SEt ↵ ▽ triG ↵ ▽ MAinS ↵ rAnGE: XXXX V ↵  
H-triG: XXXXXX ↵  
L-triG: XXXXXX ↵  
triG drPout: XXXX V ↵  
triG PULSE: XXXX V ↵  
PrEtr: OFF/on ↵  
**rEtriG: OFF/on ▽△↵**

---



**Note!**

We recommend the entry of a defined memory duration prior to activation of the re-trigger (see "Memory Duration: durA" on page 50).

---

**Time Trigger: tiME triG, dAtE trig**

If this function has been activated, and if the memory mode is on, measurement values are only stored as of the specific point in time, after which current date and time agree with the values selected for tiME triG and dAtE triG.

SEt ↵ ▽ triG ↵ ▽ MAinS ↵ rAnGE: XXXX V ↵  
H-triG: XXXXXX ↵  
L-triG: XXXXXX ↵  
triG drPout: XXXX V ↵  
triG PULSE: XXXX V ↵  
PrEtr: OFF/on ↵  
rEtriG: OFF/on ↵  
**tiME triG: OFF/on ▽△↵**  
**00:00:00 ▽△↵**  
**dAtE triG: OFF/on ▽△↵**  
**00:00:00 ▽△↵**

---



**Note!**

Current date and time should be checked and corrected if necessary, before the time trigger is activated, and before trigger date and time are selected.

---

# Trigger Menu

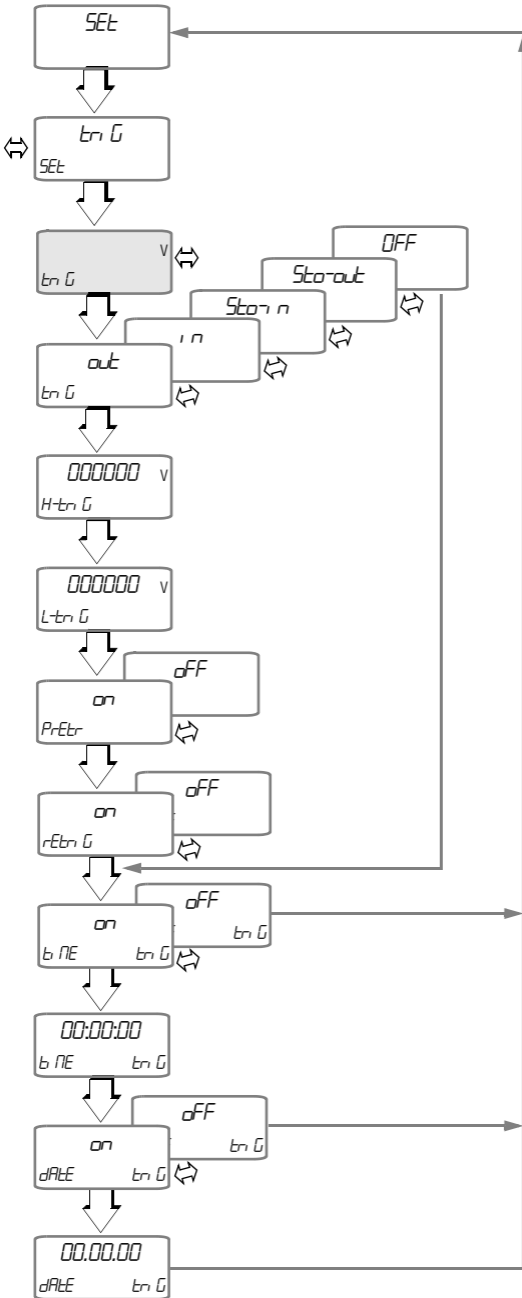

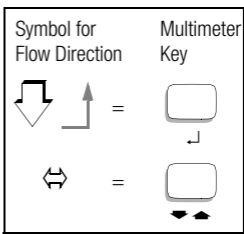
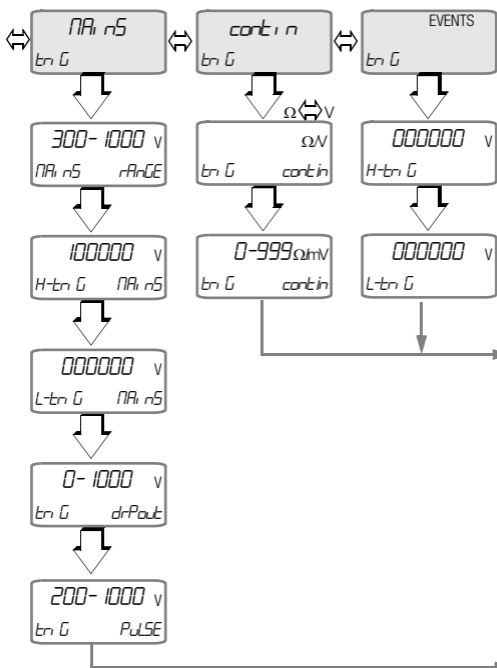

## 23 Setting the Measurement Parameters

The menu mode allows for the setting of operating parameters, data queries and activation of the interface.

- ⇨ The menu mode is entered by pressing the ↵ key (ENTER) twice if the instrument is switched off, or only once if the instrument is switched on and in the measuring mode. "SEt" appears at the display.
- ⇨ Repeated activation of the ▽△ key causes alternate opening of the main menus "inFo", "SEnd" and finally once again "SEt".
- ⇨ After the desired main menu has been selected, the sub-menus can be opened with the ↵ key.
- ⇨ The desired sub-menu can be selected by repeatedly activating the ▽△ key.
- ⇨ Activate the ↵ key, in order to change the corresponding parameter in the sub-menu.
- ⇨ After the characters or the unit of measure have been selected, the instrument is returned to the menu mode (SEt) with the ↵ key.
- ⇨ Return to the measuring mode by pressing and holding the ESCIFUNC key until the measuring display appears.
- ⇨ In order to switch the multimeter off, press and hold the ON key until the display goes blank.

### Examples

#### Battery Voltage Query

SEt  inFo   bAtt  3.0 V.  
          ↓                  ↓                  ↓                  ↓

or in abbreviated form:

SEt ▽ inFo ↵ ▽ bAtt ↵ 3.0 V.

#### Setting Time

SEt ↵ ▽ tiME ↵ 10:24:42

*Setting hours minutes and seconds:*

- ▽△ Select characters, cursor position blinks. Press and hold key for rapid change of characters.
- ↵ After entry acknowledgement, the next entry position (to the right) blinks.
- ◀ This key sends the cursor back to the previous entry position.
- ↵ After acknowledgement for the last entry position (extreme right) – in this case seconds – the instrument returns to the menu mode.



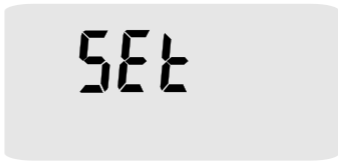
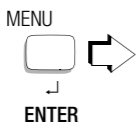

Main menu SEt is active, menu mode

**Main Menus METRA HIT 28S**



**Main Menus METRA HIT 29S**

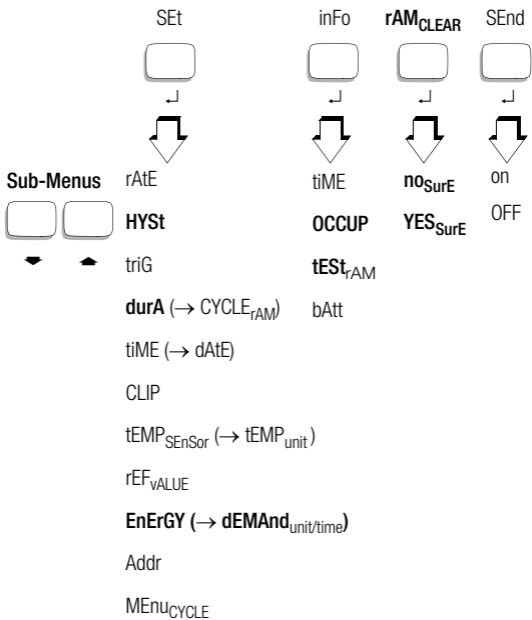

**Parameters in Bold Typeface:**  
 METRA HIT 29S only

## 23.1 Description of General Parameters in the *SEt* Menu

### 23.1.1 Sampling Rate: *rAtE*

The sampling rate determines the interval, after which the respective measurement values are transmitted to the data interface or the measurement value memory.

The following sampling rates are possible:

0.05, 0.1, 0.2, 0.5, 00:01, 00:02, 00:05, 00:10, 00:20, 00:30, 01:00, 02:00, 05:00, 10:00, SAMPLE, dAtA.

Only METRA HIT 29S Memory mode in switch position  $V \equiv$ : 0.0005, 0.001, 0.002, 0.005, 0.01, 0.02.

Certain limit values apply to the various measured quantities for the given sampling rates. Actual values may not fall below these limits (see table below).

Measured Quantity	Sampling Rate
$V \equiv$	0.0005 s for memory mode (METRA HIT 29S only)
$V \equiv, A \equiv,$	0.05 s
$V \equiv, A \equiv, \text{EVENTS } V \equiv, \rightarrow + \text{ (d)}$	0.5 s
$\Omega, \Omega \text{ (d)}, \text{Count}, \text{ }^\circ\text{C (Pt100, Pt1000)}, \text{MAinS}$	0.5 s
$V \sim, \text{Hz}, \text{dB}, \text{EVENTS } V \sim, \text{W}, \text{VA}, \text{VAr}, \text{Wh}$	1 s
$^\circ\text{C (J, K)}$	2 s
F	0.5 ... 10 s

#### **SAMPLE (METRA HIT 29S only– Storage of Individual Values)**

If the sampling rate (“rate” menu) is set to “SAMPLE” (event), the momentary measurement value is stored to memory by simultaneously pressing the FUNC and ON/↓ keys. This is briefly acknowledged with MEM and TRIG in the display and by an acoustic signal. Storage is done in the same data block as long as the measuring function is not changed.

#### **dAtA**

This setting provides for transmission of the measurement values from the multimeter to the interface, or storage of these values, which have been generated in the measurement value storage function, “DATA”.

#### **Setting the Sampling Rate**

SEt ↓ ▽ rAtE ↓ s.zht / mm:ss ▽ △ ↓

t: thousandths of a second, h: hundredths of a second,

z: tenths of a second, s: seconds, mm: minutes

### 23.1.2 Rapid Query: *Menu*<sub>CYCLE</sub>

After this function has been activated (MEnu<sub>CYCLE</sub> parameter set to ON) the last sub-menu to which an entry was made is displayed, when the SET main menu is opened.

SEt ↓ ▽ MEnu<sub>CYCLE</sub> ↓ OFF ▽ △ on ↓

### 23.1.3 *tiME* und Datum *dAtE*

Current time and date allow for real-time recording of measurement values (TT: day, MM: month, JJ: year).

SEt ↓ ▽ tiME ↓ hh:mm:ss

hh ▽ △ ↓ mm ▽ △ ↓ ss ▽ △ ↓

(hh: hours, mm: minutes, ss: seconds)

dAtE ↓ TT.MM.JJ

TT ▽ △ ↓ MM ▽ △ ↓ JJ ▽ △ ↓

## 23.2 Parameter Description of Menu Item: *inFo*

### Time Query: *tiME*

SEt ▾ inFo ↵ tiME ↵ 10:24:42.

### Battery Voltage Query: *bAtt*

SEt ▾ inFo ↵ ▽△ bAtt ↵ 3.0 V.

### Testing Random Access Memory - *tEst<sub>rAM</sub>*

---



#### Attention!

Activating this function deletes all stored measurement values from memory. Do not perform the RAM test while any of the following functions are active: events counter, count zero crossing, power measurement, line fault recording or memory mode.

---

Starting the RAM test:

SEt ▾ info ↵ ▽△ tEst<sub>rAM</sub> ↵ no ▾ YES ↵

No other functions may be activated during the RAM test (the "bUSY" message is displayed). The test lasts approximately 1 minute. Two test samples are written to memory, and are subsequently read out.

If the test is completed successfully, "PASSEd" appears at the display.

Significance of possible messages:

bUSY           RAM test is running

PASSEd        Test successfully completed

Err1           Test sample for this test is faulty

Err2           Test sample for a previous test is faulty

If Err1 and/or Err2 occur, a hardware problem may exist. Send the multimeter to our Repair and Replacement Parts Service Department.

### Querying Memory Occupancy

See "Memory Occupancy Query: OCCUP" on page 50.

## 23.3 Default Settings

Previously selected settings can be deleted, and default settings can be restored. This may be helpful in the following situations:

- After the occurrence of hardware or software problems
  - If you feel that the multimeter is not functioning properly
- ⇒ Briefly disconnect the battery.
- ⇒ Simultaneously activate the ESCIFUNC, MANIAUTO and DATAICLEAR keys and hold them depressed while connecting the battery.

## 23.4 List of All Parameters

Parameter	METRA HIT 28S	METRA HIT 29S	Page: Heading
Addr	•	•	62: Addr – Address
bAtt	•	•	59: Battery Voltage Query: bAtt . 74: Battery
bd232	•	•	62: SI232/RS232/bd232 – Interface Adapters
CLIP	•	•	23: Current Clip Setup Menu:
cont in $\Omega$	•	•	25: Continuity Testing for Resistance Measurement
cont in V	•	•	27: Continuity Testing for Diode Tests
CYCLE <sub>rAM</sub>	•	•	50: Toroidal Core Memory Mode: CYCLERAM
dAtA	•	•	58: Sampling Rate: rAtE .
dAtE	•	•	58: tiME und Datum dAtE
dAtE trig	–	•	53: Time Trigger: tiME triG, dAtE trig
dEMAnd <sub>time</sub>	–	•	41: EnErGY Menu for Energy Measurement
dEMAnd <sub>unit</sub>	–	•	41: EnErGY Menu for Energy Measurement
durA	–	•	50: Memory Duration: durA
EnErGY	–	•	41: EnErGY Menu for Energy Measurement
EVENTS	•	•	32: Event Counting
H-triG	•	•	32: Example Entries for Trigger Thresholds
H-triG	–	•	46: Trigger Thresholds H-triG and L-triG 52: Upper Limit H-triG, Lower Limit L-triG
HYSt	–	•	51: Hysteresis: HYSt
L-triG	•	•	32: Example Entries for Trigger Thresholds
L-triG	–	•	46: Trigger Thresholds H-triG and L-triG 52: Upper Limit H-triG, Lower Limit L-triG
MAInS rAnGE	–	•	46: Mains Failure Measuring Range: MAInS rAnGE
MEnu <sub>CYCLE</sub>	•	•	58: Rapid Query: MenuCYCLE .
ModEM	•	•	62: ModEM – Modem
PrEtr	–	•	52: Pre-Trigger: PrEtr
OCCUP	–	•	50: Memory Occupancy Query: OCCUP
rAM <sub>CLEAR</sub>	–	•	50: rAMCLEAR – Delete Memory
rAtE	•	•	58: Sampling Rate: rAtE .
rEF <sub>VALUE</sub>	•	•	19: Alternating Voltage Level Measurement (dB) 36: $\Delta$ Operating Mode, Reference Value REF.
rEtriG	–	•	53: Re-Trigger rEtriG
rs232	•	•	62: SI232/RS232/bd232 – Interface Adapters
SAMPLE	–	•	58: Sampling Rate: rAtE .
SEnd	•	•	61: Starting Transmission Mode Operation via Menu Functions
si232	•	•	62: SI232/RS232/bd232 – Interface Adapters
Sto`ou	–	•	51: Trigger Functions
Sto`in	–	•	51: Trigger Functions
tEMP <sub>SEnSor</sub>	•	•	30: Temperature Measurement
tEMP <sub>unit</sub>	•	•	30: Temperature Measurement
tES <sub>rAM</sub>	–	•	59: Testing Random Access Memory - tESrAM
tiME	•	•	58: tiME und Datum dAtE
tiME triG	–	•	53: Time Trigger: tiME triG, dAtE trig
triG drPout	–	•	46: Drop Out Trigger Level: triG drPout
triG PULSE	–	•	46: Pulse Trigger: triG PULSE

## 24 Data Transmission via the RS 232 Interface

The multimeter is equipped with an infrared interface for the transmission of measurement data to electronic data processing systems. Measurement values are optically transmitted via infrared light through the housing to an interface adapter (accessory), which is plugged into the multimeter. The RS232 interface at the adapter allows for connection to the PC. The measurement data are transmitted to the PC with a cable.

Furthermore, commands and parameters can be uploaded from the PC to the multimeter. For example:

- Select and read our measuring parameters
- Select measuring function and range
- Start measurement
- Read out measurement values

### 24.1 Activating the Interface

The interface is manually activated for data transmission as described below. This operating mode provides for continuous uploading of measurement data from the instrument to the PC via the interface adapter.

The interface is activated automatically for the receipt of data (downloading from the PC to the instrument) as soon as transmission is started at the PC.

#### Starting Transmission Mode Operation via Menu Functions

SEt ▾ SEnd ↵ OFF ▾ on ↵

#### Starting Transmission Mode Operation via Shortcut

- ⇨ With the instrument switched off, press and hold the DATA/CLEAR key and then activate the ON key.

The blinking  symbol at the display indicates that the interface has been activated.

---

#### Note!

The “SI 232<sub>onLinE</sub>” operating mode must be selected for transmission via the SI232 (memory mode: “SI 232<sub>StorE</sub>”).

Other adapters are automatically activated as soon as an event occurs.

---

#### Automatic Activation and Deactivation in the Transmission Mode

The display is automatically switched off automatically between two samples in order to extend battery service life.

The following exceptions apply:

Events counting mode, count zero-crossings (counter), stopwatch mode, continuous operation, power measurement and power disturbance recording (mains).

The display is automatically reactivated as soon as an event occurs.

## 24.2 Selecting Interface Parameters

### Addr – Address

If several multimeters, or interface or memory adapters, are connected to the PC, each device needs its own address. Address 1 should be assigned to the first device, address 2 to the second etc. If only one multimeter is connected to the PC, address number 1 should be used.

### SI232/rS232/bd232 – Interface Adapters

The type of interface adapter in use must be selected for this parameter.

The SI232-II memory adapter allows for on-site storage of measurement values for METRA HIT 28S measuring instrument. The “SI 232<sub>StorE</sub>” operating mode must be selected. “SI 232<sub>onLinE</sub>” must be selected for online transmission to the PC (without storage to memory).

### ModEM – Modem

Indication must be made here as to whether or not a modem has been connected between the adapter and the PC.

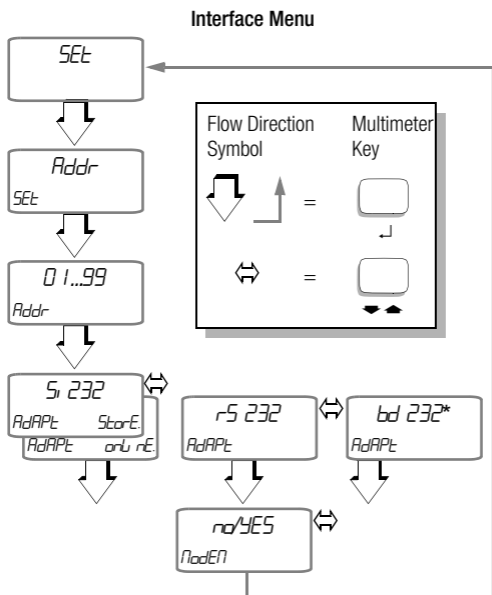

\*also for USB-HIT

## Accessories

**Interface adapter BD232** without memory allows remote control of the multimeter, as well as the transmission of measurement data from up to six multimeters to the PC.

**Interface adapter USB-HIT** is functionally identical to the BD232 interface adapter, although bidirectional transmission takes place between the IR and the USB interface in this case.

The driver to be installed assigns a virtual COM interface to the instrument. It is not possible to set up a multi-channel system with this adapter.

**SI232-II memory adapters** make it possible to store measurement values on-site when using multimeters which are not equipped with internal memory, for example the METRA HIT 28S. They also allow for multimeter remote control (parameters configuration), or the transmission of measurement data from up to three multimeters to the PC.

### **METRAwin<sup>®</sup>10/METRAHit<sup>®</sup> Software**

The METRAwin<sup>®</sup>10/METRAHit<sup>®</sup> software package includes a WINDOWS full version and is compatible with WINDOWS 95, 98 and NT.

Measurement data from several METRA HIT 28S or METRA HIT 29S multimeters can be simultaneously acquired, stored, represented and documented with METRAwin<sup>®</sup>10/METRAHit<sup>®</sup> software. Measurement values can be displayed in the following formats:

- digital display, similar to multimeter display (up to four multimeters)
- as a characteristic curve (XY and Yt), similar to a four channel recorder
- in tabular form (data logger: up to ten channels).

Measurement data are stored in ASCII format for further processing.

The following prerequisites must be fulfilled for the implementation of METRAwin<sup>®</sup>10/METRAHit<sup>®</sup> software:

#### **Hardware: You need**

- a WINDOWS and IBM compatible PC with at least a 200 MHz Pentium CPU and 32 MB main memory
- an SVGA monitor with a minimum of 800 x 600 pixels
- a hard disc with 20 MB free memory
- a 3.5" floppy disc drive for 1.4 MB floppy discs
- a MICROSOFT compatible mouse
- if you want to print your data:  
a printer which is supported by WINDOWS.
- 1 free serial COM interface for using **BD232** or **SI232-II**  
or
- 1 USB interface for using USB-HIT

#### **Software: You need**

- MS WINDOWS 95, 98, ME, NT 4.0, 2000 or XP.

Meas. Function	Measuring Range	Resolution at Measuring Range Upper Limit		
		300 000 <sup>1)</sup>	30 000 <sup>1)</sup>	3 000 <sup>1)</sup>
<b>V</b>	300 mV	1 $\mu$ V	10 $\mu$ V	
	3 V	10 $\mu$ V	100 $\mu$ V	
	30 V	100 $\mu$ V	1 mV	
	300 V	1 mV	10 mV	
	600 V	10 mV	100 mV	
<b>dB</b>	see table on page 67			
<b>A</b>	300 $\mu$ A	1 nA	10 nA	
	3 mA	10 nA	100 nA	
	20 mA 30 mA	100 nA	1 $\mu$ A	
	300 mA	1 $\mu$ A	10 $\mu$ A	
	3 A		100 $\mu$ A	
	10 A		1 mA	
<b><math>\Omega</math></b>	300 $\Omega$	1 m $\Omega$		
	3 k $\Omega$	10 m $\Omega$		
	30 k $\Omega$	100 m $\Omega$		
	300 k $\Omega$	1 $\Omega$		
	3M $\Omega$ <sup>4) 5)</sup>	10 $\Omega$		
	30M $\Omega$ <sup>4) 5)</sup>	100 $\Omega$		
<b><math>\Omega</math> <math>\square</math>)</b>	300 $\Omega$			0,1 $\Omega$
<b><math>\rightarrow \square</math>)</b>	300 mV			100 $\mu$ V
<b><math>\rightarrow \rightarrow</math></b>	3 V		100 $\mu$ V	
<b>F</b>	3nF <sup>5)</sup>			1 pF
	30 nF			10 pF
	300 nF			100 pF
	3 $\mu$ F			1 nF
	30 $\mu$ F			10 nF
	300 $\mu$ F			100 nF
	3000 $\mu$ F			1 $\mu$ F
	30000 $\mu$ F			1 $\mu$ F
<b>Hz</b>	300,000 Hz	0,001 Hz		
	3,00000 kHz	0,01 Hz		
	300,000 kHz	1 Hz		
	100 min <sup>2)</sup>		100 ms (1/10 s)	
<b><math>^{\circ}</math>C/<math>^{\circ}</math>F</b>	Pt 100/ Pt 1000	- 200.0 ... + 100.0 $^{\circ}$ C		0.1 $^{\circ}$ C
		+ 100.0 ... + 850.0 $^{\circ}$ C		
	K NiCr-Ni	- 270.0 ... + 1372.0 $^{\circ}$ C		0.1 $^{\circ}$ C
		J Fe-CuNi	- 210.0 ... + 1200.0 $^{\circ}$ C	



Meas. Function	Measuring Range	Input Impedance	
		—	$\approx$
<b>V</b>	300 mV	> 20M $\Omega$	5 M $\Omega$ // < 50 pF
	3 V	11M $\Omega$	5 M $\Omega$ // < 50 pF
	30 V	10M $\Omega$	5 M $\Omega$ // < 50 pF
	300 V	10M $\Omega$	5 M $\Omega$ // < 50 pF
	600 V	10M $\Omega$	5 M $\Omega$ // < 50 pF
<b>dB</b>	see table on page 67	—	same as V $\approx$
		Approx. Voltage Drop at Meas. Range Upper Limit	
		—	$\approx$
<b>A</b>	300 $\mu$ A	160 mV	160 mV
	3 mA	160 mV	160 mV
	20 mA 30 mA	170 mV	170 mV
	300 mA	300 mV	300 mV
	3 A	110 mV	110 mV
	10 A	350 mV	350 mV
		Open-Circuit Voltage	Meas. Current at Meas. Range Upper Limit
<b><math>\Omega</math></b>	300 $\Omega$	0.6 V	max. 250 $\mu$ A
	3 k $\Omega$	0.6 V	max. 45 $\mu$ A
	30 k $\Omega$	0.6 V	max. 4.5 $\mu$ A
	300 k $\Omega$	0.6 V	max. 1.5 $\mu$ A
	3M $\Omega$	0.6 V	max. 150 nA
	30M $\Omega$	0.6 V	max. 15 nA
<b><math>\Omega</math> <math>\rightarrow</math>)</b>	300 $\Omega$	max. 3 V	max. 1 mA
<b><math>\rightarrow</math> <math>\rightarrow</math>)</b>	300 mV	max. 3 V	max. 1 mA
<b><math>\rightarrow</math> <math>\rightarrow</math></b>	3 V–	max. 3 V	max. 1 mA
		Discharge Resistance	$U_{0\max}$
<b>F</b>	3 nF	10M $\Omega$	3 V
	30 nF	10M $\Omega$	3 V
	300 nF	1M $\Omega$	3 V
	3 $\mu$ F	100 k $\Omega$	3 V
	30 $\mu$ F	11 k $\Omega$	3 V
	300 $\mu$ F	2 k $\Omega$	3 V
	3000 $\mu$ F	2 k $\Omega$	3 V
	30000 $\mu$ F	2 k $\Omega$	3 V
		$f_{\min}^{3)}$	
<b>Hz</b>	300.000 Hz	1 Hz	
	3.00000 kHz	1 Hz	
	300.000 kHz	1 Hz	

- 1) Display: 5¼ places for DC and 4¼ places for AC.  
A separate resolution and sampling rate can be selected in the rAtE menu for the storage and transmission of measurement values.
- 2) Stopwatch: format: **mm:ss:hh** where m=minute, s=second and h=hundredth second, max.: 99:59:59; key-controlled only
- 3) Smallest measuring frequency for sinusoidal measurement signals symmetric to zero point
- 4) Use short and screened measurement cables in the case of high-resistance measurements.
- 5) Perform the measurements in this range with inserted batteries and without connecting the power supply unit to prevent a 100 Hz hum from affecting the results.

Meas. Function	Inherent Deviation at max. Resolution at Reference Conditions		Overload Capacity <sup>7)</sup>	
	$\pm(\dots\% \text{ rdg.} + \dots\% \text{ r.} + \dots \text{ d})$	$\pm(\dots\% \text{ rdg.} + \dots \text{ d})$	Overload Value	Overload Duration
	—	$\approx$ <sup>8)</sup>		
300 mV	$0.02 + 0.010 + 5^{10)}$	$0.5 + 30$	600 V DC AC TRMS sine	continuous
3 V	$0.02 + 0.005 + 5$	$0.2 + 30$		
30 V	$0.02 + 0.005 + 5$	$0.2 + 30$		
300 V	$0.02 + 0.005 + 5$	$0.2 + 30$		
600 V	$0.02 + 0.005 + 5$	$0.2 + 30$		
<b>dB</b>	—	$\pm 0.1 \text{ dB}^{14)}$		
	—	$\approx$ <sup>8)</sup>		
300 $\mu\text{A}$	$0.05 + 0.02 + 5$	$0.5 + 30$	0.36 A	continuous
3 mA	$0.05 + 0.01 + 5$	$0.5 + 30$		
20 mA	$0.02 + 0.01 + 5$	$0.5 + 30$		
30 mA	$0.05 + 0.01 + 5$			
300 mA	$0.1 + 0.01 + 5$	$0.5 + 30$	10 A <sup>9)</sup>	continuous
3 A	$0.2 + 0.05 + 5$	$0.7 + 30^{15)}$		
10 A	$0.2 + 0.05 + 5$	$0.5 + 30$		
	$\pm(\dots\% \text{ rdg.} + \dots\% \text{ r.} + \dots \text{ d})$			
300 $\Omega$	$0.05 + 0.01 + 5^{10)}$	600 V DC AC TRMS sine	10 min	
3 k $\Omega$	$0.05 + 0.01 + 5^{10)}$			
30 k $\Omega$	$0.05 + 0.01 + 5$			
300 k $\Omega$	$0.05 + 0.02 + 5$			
3M $\Omega$	$0.1 + 0.02 + 5$			
30M $\Omega$	$1 + 0.2 + 5$			
$\Omega$ $\square$ )	$1 + 0 + 3$			
$\rightarrow$ $\square$ )	$0.2 + 0 + 3$			
$\rightarrow$ 3 V-	$0.2 + 0 + 3$			
	$\pm(\dots\% \text{ rdg.} + \dots\% \text{ r.})$			
3 nF	$1.0 + 0.2^{10)}$	600 V DC AC TRMS sine	10 min	
30 nF	$1.0 + 0.2^{10)}$			
300 nF	$1.0 + 0.2$			
3 $\mu\text{F}$	$1.0 + 0.2$			
30 $\mu\text{F}$	$1.0 + 0.2$			
300 $\mu\text{F}$	$5.0 + 1$			
3 mF	$5.0 + 1$			
30 mF	$5.0 + 1$			
	$\pm(\dots\% \text{ rdg.} + \dots \text{ d})$			
300.000 Hz	$0.05 + 1^{11)}$	600 V	continuous	
3.00000 kHz	$0.05 + 1^{11)}$	600 V		
300.000 kHz	$0.05 + 1^{11)}$	300 V 30 V		
100 min	$\pm 15 \text{ D}$		600 V	
	$\pm(\dots\% \text{ rdg.} + \dots \text{ d})$			
Pt 100/ Pt 1000	$-200.0 \dots +100.0 \text{ }^\circ\text{C}$	$0.5 \text{ K} + 3^{12)}$	600 V DC TRMS sine	10 min
	$+100.0 \dots +850.0 \text{ }^\circ\text{C}$	$0.2 + 3^{12)}$		
K NiCr-Ni	$0.7 + 3^{12, 13)}$			
J Fe-CuNi	$0.8 + 3^{12, 13)}$			

## dB Ranges

Measuring Range	Display Range Reference Voltage $V = 0.775 \text{ V}$	Resolution
300mV $\sim$	- 48 dB ... - 8 dB	0.01 dB
3V $\sim$	- 38 dB ... + 12dB	0.01 dB
30V $\sim$	- 18 dB ... + 32 dB	0.01 dB
300V $\sim$	+ 2 dB ... + 52 dB	0.01 dB
600V $\sim$	+ 22 dB ... + 63 dB	0.01 dB
	Display (dB) = $20 \lg V_x (V) / V_{REF}$	

## AUTO SELECT: Automatic Measured Quantity Recognition

Measured Quantity	Measuring Range for Recognition	Condition	Recognition Time
Voltage $V \overline{\overline{=}}$	$V_{TRMS} > 0.81 \text{ V} \dots 600 \text{ V}$	—	1 s
Voltage $V \sim$	$V_{TRMS} > 1 \text{ V} \dots 600 \text{ V}$	Frequency > 20 Hz	1 s
Resistance	$0 \Omega \dots 15 \text{ M}\Omega$	—	1 s
Capacitance	$> 1.5 \text{ nF} \dots 300 \mu\text{F}$	Electrolytic capacitors must be properly connected	1 s
Diode	Conducting state voltage: max. 1 V	Diode must be properly connected: Anode to $\rightarrow$	1 s

Overload at AUTO SELECT max. 500 V DC AC TRMS sine.

- 7) At  $0^\circ \dots + 40^\circ \text{C}$
- 8) Values of less than 100 digits are suppressed,  
16 ... 45 ... 65 Hz ... 100 kHz sine. See page 68 for influences
- 9) 12 A – 5 min, 16 A – 30 s
- 10) When “zero balancing” function is active, ZERO display
- 11) Range 300 mV  $\overline{\overline{=}}$ :  $U_E = 50 \text{ mV}_{eff/rms} \dots 300 \text{ mV}_{eff/rms}$   
 3 V  $\overline{\overline{=}}$ :  $U_E = 0,3 \text{ V}_{eff/rms} \dots 3 \text{ V}_{eff/rms}$   
 30 V  $\overline{\overline{=}}$ :  $U_E = 3 \text{ V}_{eff/rms} \dots 30 \text{ V}_{eff/rms}$   
 300 V  $\overline{\overline{=}}$ :  $U_E = 30 \text{ V}_{eff/rms} \dots 300 \text{ V}_{eff/rms}$   
 600 V  $\overline{\overline{=}}$ :  $U_E = 300 \text{ V}_{eff/rms} \dots 600 \text{ V}_{eff/rms}$   
 for voltages > 100 V: power limiting =  $3 \cdot 10^6 \text{ V} \cdot \text{Hz}$
- 12) Plus sensor deviation
- 13) Without integrated reference junction,  
with integrated reference junction, additional error:  $\pm 2 \text{ K}$
- 14) For  $V > 10\%$  of the measuring range
- 15) valid as from 500 digits

## Abbreviations

rdg. = Reading  
r. = Measuring range  
d = Digit

## Influence Variables and Effects

Influence Variable	Influence Range	Measured Quantity / Measuring Range <sup>1)</sup>	Influence Effect ppm/K
Temperature	0 °C ... +21 °C and +25 °C ... +40 °C	V $\equiv$	50
		V $\sim$	50
		300 $\mu$ A ... 30 mA $\equiv$ / $\approx$	180
		300 mA $\equiv$ / $\approx$	290
		3 A / 10 A $\equiv$ / $\approx$	200
		300 $\Omega$ ... 300 k $\Omega$	100
		3 M $\Omega$	200
		30 M $\Omega$	1000
		3 nF ... 30 $\mu$ F	500
		Hz	50
		°C	100

Influence Variable	Frequency	Influence Range (max. Resol.)	Influence Effect <sup>2)</sup> $\pm$ ... % rdg.
Frequency $V_{AC}$	> 15 Hz ... 45 Hz	300.000 mV	2 + 10 d
	> 65 Hz ... 1 kHz		0.5
	> 1 kHz ... 10 kHz		1
	> 10 kHz ... 50 kHz		3
	> 50 kHz ... 100 kHz		10
	> 15 Hz ... 45 Hz	3.00000 V 30.0000 V 300.000 V	2 + 10 d
	> 65 Hz ... 1 kHz		0.5
	> 1 kHz ... 20 kHz		1.5
	> 20 kHz ... 100 kHz		5
	> 15 Hz ... 45 Hz	600.00 V	2 + 10 d
	> 65 Hz ... 1 kHz		1
	> 1 kHz ... 10 kHz		10

Influence Variable	Frequency	Meas. Quantity / Measuring Range	Influence Effect <sup>2)</sup> $\pm$ (... % rdg. + ... d)	
			METRA HIT 29S	METRA HIT 28S
Frequency $I_{AC}$	> 15 Hz ... 45 Hz	300 $\mu$ A ... 300 mA	2 + 10	
	> 65 Hz ... 5 kHz		0.75 + 5	
	> 5 kHz ... 10 kHz		5 + 5	
	> 15 Hz ... 45 Hz	3 A	2 + 10	
	> 65 Hz ... 1 kHz		0.75 + 5	2 + 5
	> 1 kHz ... 10 kHz		5 + 5	
	> 15 Hz ... 45 Hz	10 A	2 + 10	
	> 65 Hz ... 2 kHz		0.75 + 5	
> 2 kHz ... 10 kHz	5 + 5			

1) With zero balancing

2) Indicated inherent deviation valid as of display of 10% of the measuring range

Influence Variable	Influence Range	Measured Quantity	Influence Effect <sup>3)</sup>
	Crest factor	1 ... 3	± 1 % rdg.
	CF	> 3 ... 5	± 3 % rdg.
Measured Quantity Waveform	<p>The allowable crest factor CF for the periodic quantity to be measured is dependent upon the displayed value:</p>		
	<p>Voltage and current measurement</p>		

Influence Variable	Influence Range	Measured Quantity	Influence Effect
Relative Humidity	75%	V, A, Ω F, Hz °C	1 x inherent deviation
	3 days		
	device off		

Influence Variable	Influence Range	Measuring Range	Damping ±dB
Common Mode Interference Voltage	Interference quantity max. 600 V ~	V ---	> 90 dB
	Interference quantity max. 600 V ~ 50 Hz, 60 Hz sine	300 mV ... 30 V ~	> 80 dB
		300 V ~	> 70 dB
		600 V ~	> 60 dB
Series-Mode Interference Voltage	Interference quantity V ~ , resp. measuring range nominal value, max. 600 V ~ , 50 Hz, 60 Hz sine	V ---	> 60 dB
	Interference quantity max. 600 V —	V ~	> 60 dB

<sup>3)</sup> Except for sinusoidal waveshape

## Power Measurement with the METRA HIT 29S

Meas. Function	Measuring Range	Switch Position		Resolution at Meas. Range Upper Limit	Overload Capacity at 0 ... + 40 °C	
		mA	A	10 000	Value	Duration
<b>W, VAR, VA</b>	1 mW	●		0.1 μW	V: 600 V mA: 0.36 A A: 10 A	V / mA: continuous  10 A: cont. 12 A: 5 min 16 A: 30 s
	10 mW	●		1 μW		
	100 mW	●		10 μW		
	1 W	●		0.1 mW	DC AC TRMS sine	
	10 W	●	●	1 mW		
	100 W	●	●	10 mW		
	1 kW	●	●	0.1 W		
	10 kW		●	1 W		

## Intrinsic Error and Frequency Influence for Power and Energy Measurement with the METRA HIT 29S

Meas. Quantity	Meas. Range	Intrinsic Error (... % of rdg. + ... d)		
		15 Hz ... 45 Hz	45 Hz ... 65 Hz	65 Hz ... 1 kHz
Active Power	300 mA ... 10 A	1.3+20	1+20 *	3+20
Reactive Power		2.5+20	1.5+20	3+20
Apparent Power		1.2+20	1+20	1.2+20
Power Factor	±(0.02 ... 1)	2+2	1+2	2+2
¼ hr. Power		1.2+20	1+20	1.3+20
Energy		1.2+2	1+2	1.3+2
Voltage		0.4+30	0.3+30	0.4+30
Current		0.7+30	0.6+30	0.9+30

\* also applies for measurements of DC quantities

## Line Monitoring with the METRAHit® 29S

Fault Type	Meas. Function / Measuring Range	Resolution	Intrinsic Error for Highest Resolution under Reference Conditions	Pulse Duration
Drop Out *	300 V	4 V	5% of rdg + 5% range	Sampling Rate 2 ms
	600 V	40 V	10% of rdg + 10% range	
Pulse	200 ... 600 V	10 V	50 V	0.5 ... 5 μs

\* Settings via drop out trigger

## Real-Time Clock

Accuracy ±1 min/month

Temp. Influence 50 ppm/K

## Reference Conditions

Ambient Temp. +23 °C ±2 K

Relative Humidity 40 ... 60%

Frequency of

Measured Quantity 45 ... 65 Hz

Waveform of Measured Quantity	Sine
Battery Voltage	3 V ± 0.1 V
Adapter Voltage	5 V ± 0.2 V

## Response Time

Response Time (after manual range selection)

Measured Quantity / Measuring Range	Digital Display Response Time	Measured Quantity Step Function
V $\overline{\sim}$ , V $\sim$ , A $\overline{\sim}$ , A $\sim$	1.5 s	from 0 to 80% of measuring range upper limit
300 $\Omega$ ... 3 M $\Omega$	2 s	from $\infty$ to 50% of measuring range upper limit
30 M $\Omega$	5 s	
Continuity	< 50 ms	
$\rightarrow$	1.5 s	
3 nF ... 300 $\mu$ F	max. 2 s	from 0 to 50% of measuring range upper limit
3 000 $\mu$ F	max. 7 s	
30 000 $\mu$ F	max. 14 s	
>10 Hz	max. 1.5 s	
$^{\circ}$ C	max. 3 s	

## Display

LCD field (65 mm x 30 mm) with display of up to 3 measurement values, unit of measure, current type and various special functions.

Display / Char. Height	7 segment characters Main Display: 12 mm Sub-Displays: 7 mm
Number of Places	5 $\frac{3}{4}$ places $\cong$ 309 999 steps
Overflow Display	"OL" is displayed
Polarity Display	"-" sign appears when plus pole is connected to "⊥"
Defective Fuse	"FUUSE" is displayed

## Display Update

V (DC, AC+DC), A, $\Omega$ , $\rightarrow$	
EVENTS AC+DC, Count	2 per second
V AC, EVENTS AC	1 per second
W, VA, VAR, Wh	1 per second
Hz, $^{\circ}$ C (Pt100, Pt1000)	1 to 2 per second
$^{\circ}$ C (J, K)	0.5 per second

## Power Supply

Battery	2 ea. 1.5 V mignon cell alkali manganese cell per IEC LR6 zinc carbon battery per IEC R6
Service Life	with alkali manganese cell: approx. 100 hr. with zinc carbon battery: approx. 50 hr.
Battery Test	automatic display of “  ” symbol when battery voltage falls below approx. 2.3 V.

## Battery Saver Circuit

The instrument switches itself off automatically if the measurement value remains unchanged for about 10 minutes, and if none of the operating elements are activated during this time. Automatic shut-off can be disabled.

This does not apply to the following functions: events, counter, stopwatch, mains, power, transmission or menu mode (send or menu mode) and continuous operation.

## Fusing

Fuse for Ranges up to 300 mA	FF (UR) 1.6 A/1000 V AC/DC; 6.3 mm x 32 mm; breaking capacity 10 kA at 1000 V AC/DC with resistive load; protects all curr. meas. ranges up to 300 mA in combination with power diodes
Fuse for Ranges up to 10 A	FF (UR) 10 A/1000 V AC/DC; 10 mm x 38 mm; breaking capacity 30 kA at 1000 V AC/DC with resistive load; protects 3 A and 10 A

## Electrical Safety

Protection Class	II per IEC 61010-1:2001/EN 61010-1:2001/ VDE 0411-1:2002	
Measurement Category	III	IV
Operating Voltage	600 V	300 V
Contamination Level	2	2
Test Voltage	5.2 kV~ per IEC 61010-1:2001/EN 61010- 1:2001/VDE 0411-1:2002	



## Electromagnetic Compatibility, EMC

Interference Emission	EN 61326-1: 1997 class B
Interference Immunity	EN 61326: 1997/A1: 1998 IEC 61000-4-2: 1995 IEC 61000-4-2: 1995/A1: 1998 8 kV atmosph. discharge 4 kV contact discharge IEC 61000-4-3: 1995+A1: 1998: 3 V/m IEC 61000-4-4: 1995: 0.5 kV

## Data Interface

Data Transmission	optical with infrared light, through housing <i>With accessory interface adapter</i>
Type	RS232C, serial, per DIN 19241
Baud Rate Unidirectional (read data) (MM → PC)	RS232: 9600 bauds (METRA HIT 22 ... 29S), SI232: all adjustable baud rates
Baud Rate, Bidirectional (read data and set parameters) (MM ↔ PC)	SI232-II: all adjustable baud rates BD232, USB-HIT: 9600 bauds

## Ambient Conditions

Operating Temperature Range	−20 °C ... +50 °C
Storage Temperature Range	−25 °C ... +70 °C (without batteries)
Relative Humidity	max. 75%, no condensation
Elevation	to 2000 m
Deployment	indoors; outdoors: only in the specified ambient conditions

## Mechanical Design

Dimensions	84 mm x 195 mm x 35 mm
Weight	METRA HIT 28S: approx. 350 g with batteries METRA HIT 29S: approx. 405 g with batteries
Protection Type	IP 50 Extract from table on the meaning of IP codes

IP XY (1 <sup>st</sup> digit X)	Protection against foreign object entry	IP XY (2 <sup>nd</sup> digit Y)	Protection against the penetration of water
0	not protected	0	not protected
1	≥ 50.0 mm dia.	1	vertically falling drops
2	≥ 12.5 mm dia.	2	vertically falling drops with enclosure tilted 15°
3	≥ 2.5 mm dia.	3	spraying water
4	≥ 1.0 mm dia.	4	splashing water
5	dust protected	5	water jets



### Attention!

Disconnect the instrument from the measuring circuit before opening the instrument to replace the battery or the fuse!

---

## 26.1 Battery

---



### Note!

#### Removal of Battery for Long Periods on Non-Use

The integrated quartz movement (type METRA HIT 29S) requires auxiliary power even when the instrument is switched off, and thus drains the battery. We recommend removal of the battery for lengthy periods of non-use (e.g. vacation). This prevents excessive battery discharge and leakage, which may result in damage to the instrument.

---



### Attention!

#### Battery Replacement

Stored measurement values are deleted when the battery is replaced. We recommend connecting the AC power pack, or uploading data to a PC with the help of METRAwin<sup>®</sup>10/METRAHit<sup>®</sup> software before replacing the battery, in order to prevent data loss. Operating parameters remain in memory, although date and time must be reset.

---

You can check current battery condition in the “Info” menu:  
SEt ▾ inFo ↵ ▾ bAtt ↵ X.X V.

Before initial start-up, or after storage of your instrument, make sure that no leakage has occurred at the instrument battery. Repeat this inspection at regular intervals.

If battery leakage has occurred, electrolyte from the battery must be carefully and completely removed with a damp cloth, and a new battery must be installed before the instrument can be placed back into operation.

If the “+” symbol appears at the LCD display, you should change the battery as soon as possible. You can continue to take measurements, but reduced measuring accuracy may result.

The instrument works with two 1.5 V batteries per IEC R6 or IEC LR6, or with corresponding NiCd storage batteries.

## Battery Replacement

- ⇨ Lay the instrument onto a surface with the front panel facing down, loosen the two screws at the back and lift out the housing base starting at the bottom. The housing base and top are held together at the upper front side with the help of snap hooks.
- ⇨ Remove the battery from the batteries from the battery compartment.
- ⇨ Insert two 1.5 V mignon cells into the battery compartment in the direction indicated by the polarity symbols.
- ⇨ Important for reassembly: First set the housing base onto the housing top and align accurately (see photo below). Then press the two housing halves together, first at the bottom front (a), and then at the top front (b).



- ⇨ Retighten the housing base with the two screws.
- ⇨ Please dispose of used batteries properly!

## 26.2 Power Pack

Use only the NA5/600 power pack from GMC-I Gossen-Metrawatt GmbH for power supply to your instrument. The highly insulated cable assures safety for the operator, and the power pack provides for reliable electrical isolation (secondary rating: 5 V/600 mA). When a mains power pack is used, the batteries are switched off electronically and thus can be left inside the instrument. Please also observe the footnote<sup>5)</sup> on page 65.

Country	Type	Article number
Germany	NA5/600	Z218F

## 26.3 Fuses

If at least one of the fuses blows, "FUSE" appears at the digital display, and an acoustic signal sounds at the same time.

The 10 A fuse interrupts the 3 A and 10 A ranges, and the 1.6 A fuse all other current measuring ranges. All other measuring ranges continue to function.

If a fuse blows, eliminate the cause of the overload before placing the instrument back into operation!

## Fuse Replacement

- Open the instrument as described under battery replacement.
- Remove the blown fuse with the help of an object, such as a test probe, and replace it with a new fuse.

Allowable Fuses:

Type	Dimensions	ID No.
<b>For current measuring ranges to 300 mA</b>		
FF (UR) 1.6 A/1000 V AC/DC (10 kA)	6.3 mm x 32 mm	Z109C *
<b>For 3 A and 10 A current measuring ranges</b>		
FF (UR) 10 A/1000 V AC/DC (30 kA)	10 mm x 38 mm	Z109L *

\* All of these fuses are available in packages of ten from our sales organizations and distributors.



### Attention!

Be absolutely certain that only the specified fuses are used!

The use of a fuse with different triggering characteristics, a different nominal current or a different breaking capacity places the operator, damping diodes, resistors and other components in danger. The use of repaired fuses or short-circuiting of the fuse holder is prohibited.

## 26.4 Housing

No special maintenance is required for the housing. Keep outside surfaces clean. Use a slightly dampened cloth for cleaning. Avoid the use of cleansers, abrasives or solvents.

### Device Return and Environmentally Compatible Disposal

The instrument is a category 9 product (monitoring and control instrument) in accordance with ElektroG (*German Electrical and Electronic Device Law*). This device is not subject to the RoHS directive.

We identify our electrical and electronic devices (as of August 2005) in accordance with WEEE 2002/96/EG and ElektroG with the symbol shown to the right per DIN EN 50419. These devices may not be disposed with the trash. Please contact our service department regarding the return of old devices.



## 27 Multimeter Messages

Message	Function	Significance
bUSY	RAM test	see chapter 23.2
CAnnot	memory or transmit mode	the following functions cannot be activated: set time/date, clear RAM, RAM test
Err1, Err2	RAM test	see chapter 23.2
FUSE	all operating modes	blown fuse
- -	all operating modes	battery voltage has dropped to below 2.3 V
OL	measuring	indicates overflow
PASSEd	RAM test	see chapter 23.2
storE bUSY	memory mode with high memory rate	see page 49

## 28 Accessories

### 28.1 General

The wide range of accessories available for our multimeters is regularly checked for compliance with the currently valid safety standards and is extended to include new ranges of application, if required. If you are looking for the appropriate up-to-date accessories including photo, reference number, description as well as, depending on the scope and complexity of the accessories, datasheet and operating instructions, please refer to our website [www.gossenmetrawatt.de](http://www.gossenmetrawatt.de) (→ Measuring Technology – Portable → Digital Multimeters → METRAHit ... → Accessories).

### 28.2 Characteristic Values of Measuring Cables (Scope of Supply of Safety Cable Set KS17-2)

Electrical Safety

Maximum Rated Voltage

Measuring Category 1000 V CAT III, 600 V CAT IV

Maximum Rated Current 16 A

Ambient Conditions (EN 61010-031)

Temperature -20 °C ... + 50 °C

Relative Humidity 50 ... 80%

Pollution Degree 2

## 29 Repair and Replacement Parts Service DKD Calibration Lab \* and Rental Instrument Service

If service is required, please contact:

GMC-I Gossen-Metrawatt GmbH

**Service Center**

Thomas-Mann-Strasse 20

90471 Nürnberg • Germany

Phone +49-(0)-911-8602-0

Fax +49-(0)-911-8602-2 53

E-Mail [service@gossenmetrawatt.com](mailto:service@gossenmetrawatt.com)

This address is only valid in Germany.

Please contact our representatives or subsidiaries for service in other countries.

\* **DKD** Calibration Laboratory  
for Electrical Quantities DKD-K-19701  
accredited per DIN EN ISO/IEC 17025

Accredited measured quantities: direct voltage, direct current values, DC resistance, alternating voltage, alternating current values, AC active power, AC apparent power, DC power, capacitance and frequency

## Competent Partner

GMC-I Gossen-Metrawatt GmbH is certified in accordance with DIN EN ISO 9001:2000.

Our DKD calibration laboratory is accredited by the Physikalisch Technische Bundesanstalt (*German Federal Institute of Physics and Metrology*) and the Deutscher Kalibrierdienst (*German Calibration Service*) in accordance with DIN EN ISO/IEC 17025 by under registration number DKD-K-19701.

We offer a complete range of expertise in the field of metrology: from **test reports** and **proprietary calibration certificates** right on up to **DKD calibration certificates**.

Our spectrum of offerings is rounded out with free **test equipment management**.

An **on-site DKD calibration station** is an integral part of our service department. If errors are discovered during calibration, our specialized personnel are capable of completing repairs using original replacement parts.

As a full service calibration laboratory, we can calibrate instruments from other manufacturers as well.

## 30 Warranty

The warranty period for all measuring and calibration instruments of the METRA HIT series is 3 years from delivery.

A warranty period of 12 months is granted for calibration. Warranty covers defective material and workmanship, not including any damage caused by use for any other than the intended purpose and any follow-up costs.

## **31 Product Support**

If required please contact:

GMC-I Gossen-Metrawatt GmbH

### **Product Support Hotline**

Phone +49 911 86 02 - 112

Fax +49 911 86 02 - 709

E-Mail [support@gossenmetrawatt.com](mailto:support@gossenmetrawatt.com)

### **DKD Calibration Certificate Reprints**

If you order a DKD calibration certificate reprint for your instrument, please provide us with the reference number indicated in the upper and lower most fields of the calibration mark. We do not need the instrument's serial number.

---

Printed in Germany • Subject to change without notice •  
A pdf version is available on the internet

GMC-I  **GOSSEN METRAWATT**

GMC-I Gossen-Metrawatt GmbH  
Thomas-Mann-Str. 16-20  
90471 Nürnberg • Germany  
Phone +49-(0)-911-8602-0  
Fax +49-(0)-911-8602-669  
E-Mail [info@gossenmetrawatt.com](mailto:info@gossenmetrawatt.com)  
[www.gossenmetrawatt.com](http://www.gossenmetrawatt.com)