





### Watertight Miniature Snap Action Switch

- High-quality watertight miniature snap action switch — meets IP67 (IEC 529) requirements (for lead wire types) and IP50 (for terminal types)
- Monoblock construction assures high sealing capability and is ideal for dusty places or where water is sprayed
- Wide operating temperature range of -40°C to 85°C
- Perfect for the automobile, agriculture machinery, automatic vending machine, refrigerator, ice-manufacturing, bath equipment, hot-water supply, air conditioner, and factory machine industries, which require highly environment-resistant capabilities



### Ordering Information

Actuator	Terminal	Part number	
		Model 3 A	Model 0.1 A
Pin plunger 	Solder terminals	<b>D2SW-3HS</b>	<b>D2SW-01HS</b>
	Tab terminals (#110)	<b>D2SW-3TS</b>	<b>D2SW-01TS</b>
	PCB terminals	<b>D2SW-3DS</b>	<b>D2SW-01DS</b>
	With lead wires	<b>D2SW-3MS</b>	<b>D2SW-01MS</b>
Hinge lever 	Solder terminals	<b>D2SW-3L1HS</b>	<b>D2SW-01L1HS</b>
	Tab terminals (#110)	<b>D2SW-3L1TS</b>	<b>D2SW-01L1TS</b>
	PCB terminals	<b>D2SW-3L1DS</b>	<b>D2SW-01L1DS</b>
	With lead wires	<b>D2SW-3L1MS</b>	<b>D2SW-01L1MS</b>
Simulated roller lever 	Solder terminals	<b>D2SW-3L3HS</b>	<b>D2SW-01L3HS</b>
	Tab terminals (#110)	<b>D2SW-3L3TS</b>	<b>D2SW-01L3TS</b>
	PCB terminals	<b>D2SW-3L3DS</b>	<b>D2SW-01L3DS</b>
	With lead wires	<b>D2SW-3L3MS</b>	<b>D2SW-01L3MS</b>
Hinge roller lever 	Solder terminals	<b>D2SW-3L2HS</b>	<b>D2SW-01L2HS</b>
	Tab terminals (#110)	<b>D2SW-3L2TS</b>	<b>D2SW-01L2TS</b>
	PCB terminals	<b>D2SW-3L2DS</b>	<b>D2SW-01L2DS</b>
	With lead wires	<b>D2SW-3L2MS</b>	<b>D2SW-01L2MS</b>

Note: The standard lengths of the lead wires (AWG22) of models incorporating them are 30 cm (12 in).

## Specifications

### ■ CHARACTERISTICS

		D2SW-3	D2SW-01
Operating speed (see note 2)		0.1 mm to 1 m/second (at pin plunger)	
Operating frequency	Mechanical	300 operations/min.	
	Electrical	60 operations/min.	
Insulation resistance		100 MΩ min. (at 500 VDC)	
Contact resistance		50 mΩ max. (initial value)	
Dielectric strength		1,000 VAC, 50/60 Hz for 1 min. between contacts of the same polarity	600 VAC, 50/60 Hz for 1 min. between contacts of the same polarity
		1,500 VAC, 50/60 Hz for 1 min. between current-carrying metal parts and ground, and between each terminal and noncurrent-carrying metal part	
Inrush current	NO	10 A	—
	NC	20 A	—
Vibration resistance	Malfunction	10 to 55 Hz, 1.5 mm double amplitude	
Shock resistance	Malfunction	300 m/s <sup>2</sup> (approx. 30 g)	
Life expectancy	Mechanical	5,000,000 operations min.	
	Electrical	200,000 operations min. (3 A at 125 VAC) 100,000 operations min. (2 A at 250 VAC)	200,000 operations min.
Ambient temperature	Operating	-40° to 85°C (with no icing)	
Ambient humidity	Operating	95% max.	
Enclosure rating		Reference to IP67 IEC 529 (lead wire type) and IP50 (terminal type)	
Weight	Terminal model	2 g	
	Lead wire model	10 g	

Note: 1. Data shown are of initial value.

2. The operating speed value shown is for pin plunger models. For hinge lever models, contact OMRON.

### ■ OPERATING CHARACTERISTICS

Characteristics	Part number				
	Terminal model				Lead wire model
	D2SW-3□S D2SW-01□S	D2SW-3L1□S D2SW-01L1□S	D2SW-3L3□S D2SW-01L3□S	D2SW-3L2□S D2SW-01L2□S	D2SW-3MS D2SW-01MS
OF max.	180 g	60 g	60 g	60 g	180 g
RF min.	30 g	6 g	6 g	6 g	30 g
PT max.	0.6 mm	—	—	—	0.6 mm
OT min.	0.5 mm	1.0 mm	1.0 mm	1.0 mm	0.5 mm
MD max.	0.1 mm	0.8 mm	0.8 mm	0.8 mm	0.1 mm
FP max.	—	13.6 mm	15.5 mm	19.3 mm	—
OP	8.4±0.3 mm	8.8±0.8 mm	10.7±0.8 mm	14.5±0.8 mm	8.4±0.3 mm

■ RATINGS

D2SW-3

Rated Voltage	Non-inductive load (A)				Inductive load (A)			
	Resistive load		Lamp load		Inductive load		Motor load	
	NC	NO	NC	NO	NC	NO	NC	NO
125 VAC	3	—	1	0.5	1	0.5	1	0.5
250 VAC	2	—	0.5	0.3	0.5	0.3	0.5	0.3
30 VDC	3	—	1	—	1	—	1	—

D2SW-01

Rated Voltage	Non-inductive load (A)				Inductive load (A)			
	Resistive load		Lamp load		Inductive load		Motor load	
	NC	NO	NC	NO	NC	NO	NC	NO
125 VAC	0.1	—	—	—	—	—	—	—
30 VDC	0.1	—	—	—	—	—	—	—

- Note: 1. The above current ratings are the values of the steady-state current.  
 2. Inductive load has a power factor of 0.7 min. (AC) and a time constant of 7 ms max. (DC).  
 3. Lamp load has an inrush current of 10 times the steady-state current.  
 4. Motor load has an inrush current of 6 times the steady-state current.

■ CONTACT FORM

\* Indicates lead wire color

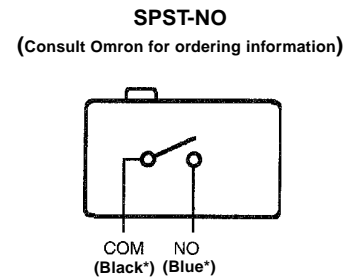
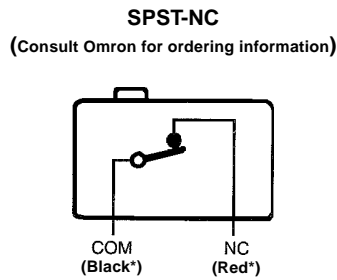
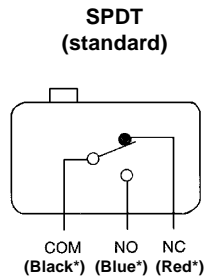

■ APPROVALS

UL (File No. E41515), CSA (File No. LR21642-388), EN 61058-1

# Dimensions

Unit: mm (inch)

■ **PIN PLUNGER**  
**D2SW-3□S**  
**D2SW-01□S**

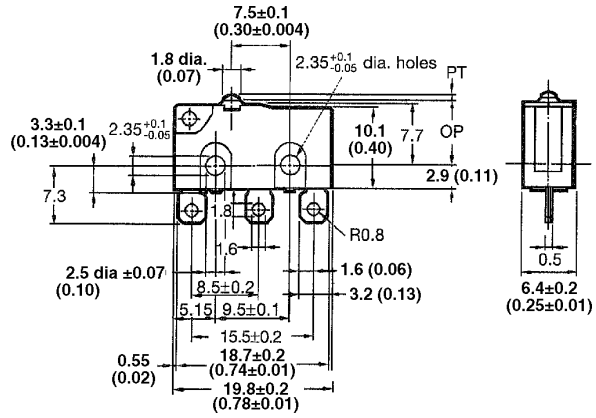
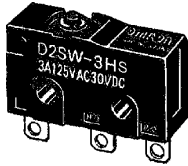

■ **HINGE LEVER**  
**D2SW-3L1□S**  
**D2SW-01L1□S**

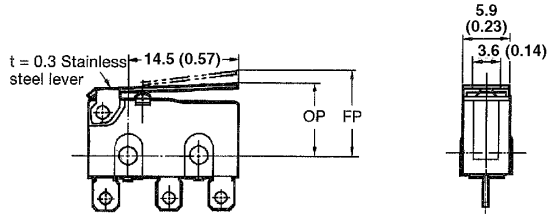
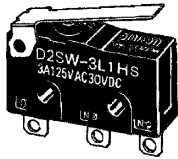

■ **SIMULATED ROLLER LEVER**  
**D2SW-3L3□S**  
**D2SW-01L3□S**

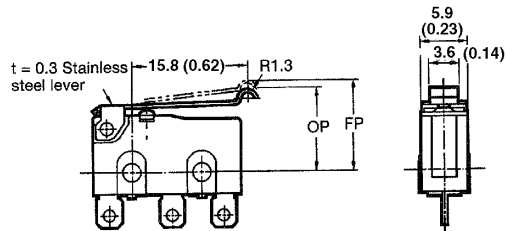
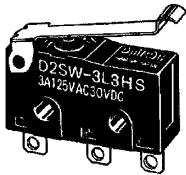

■ **HINGE ROLLER LEVER**  
**D2SW-3L2□S**  
**D2SW-01L2□S**

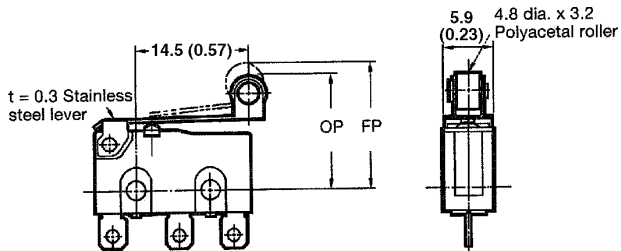
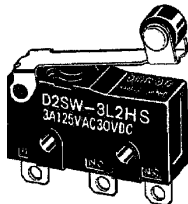

Note: 1. Unless otherwise specified, a tolerance of ± 0.4 mm applies to all dimensions.  
 2. The above illustrations and dimensions are for models with solder terminals. Refer to "Terminals" for models with tab (#110) and PCB terminals. The dimensions not described are the same as those of models with pin plungers.

**■ PIN PLUNGER LEAD WIRES**

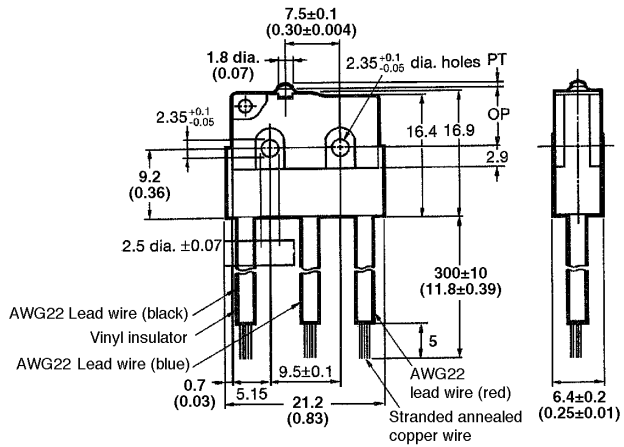
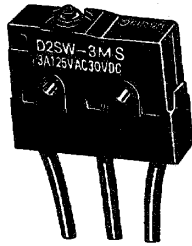

Note: 1. Unless otherwise specified, a tolerance of  $\pm 0.4$  mm applies to all dimensions.  
 2. The above illustrations and dimensions are for models with pin plungers. The dimensions and operating characteristics of the actuators of models incorporating them are the same as those of the actuators of models with both actuators and terminals.

**■ TERMINALS**

**Solder Terminals**

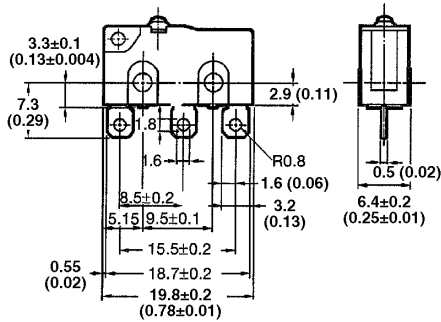

**Tab terminals (#110)**

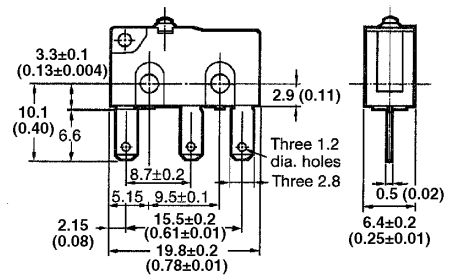

**PCB Terminals**

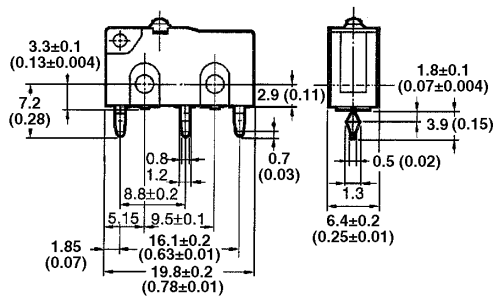

**PCB mounting**

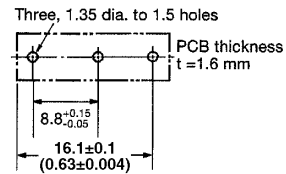

Note: Unless otherwise specified, a tolerance of  $\pm 0.4$  mm applies to all dimensions.

## Precautions

### ■ MOUNTING

Use two M2.3 mounting screws with spring washers to mount the switch. Tighten the screws to a torque of 0.23 to 0.26 N • m (2.3 to 2.7 kgf • cm)

#### Mounting holes

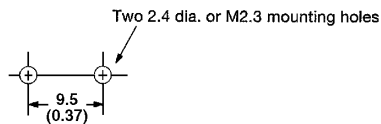

When soldering a lead wire to a terminal of the D2SW, use a soldering iron with a maximum capacity of 60 W and do not take more than 5 seconds to solder the lead wire, otherwise the characteristics of the D2SW may be altered.

Make sure that there is no icing when using the D2SW at low ambient temperatures.

### ■ OPERATIONS

Make sure that the switching object is perfectly separated from the actuator when the switch is not operated and the actuator is pressed appropriately by the switching object when the switch is operated.

The switch should be set so that its stroke will be within the rated OT when the switch is operated.

Install the switching object so that its moving direction is the same as that of the actuator.

Handle D2SW models with pin plungers with care so that the sealing rubber parts around the pin plungers will not be damaged.

### ■ ENCLOSURE RATINGS

The D2SW was tested under water and passed the following watertightness test, which however, does not mean that the D2SW can be used in the water.

JIS C0929 (rules for testing the watertightness of electrical devices and materials), class 7 (watertightness test). Refer to the following illustration for the test method.

IEC Publication 529, class IP67. Refer to the following illustration for the test method.

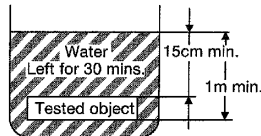

Note: The object to be tested is left in the water for 30 minutes on condition that the distance between the surface of the water and the top of the object be 15 cm minimum, and the distance between the surface of the water and the bottom of the object be 1 m minimum.

**NOTE: DIMENSIONS ARE SHOWN IN MILLIMETERS. To convert millimeters to inches divide by 25.4.**

---

**OMRON**

**OMRON ELECTRONICS LLC.**

One East Commerce Drive  
Schaumburg, IL 60173  
**1-800-55-OMRON**

**OMRON ON-LINE**

Global - <http://www.omron.com>  
USA - <http://www.omron.com/oei>  
Canada - <http://www.omron.com/oci>

**OMRON CANADA, INC.**

885 Milner Avenue  
Scarborough, Ontario M1B 5V8  
**416-286-6465**