



Datasheet

RS PRO Hermetically Sealed Enclosures

Stock number: 1862274

EN



Product Details

Hermetic enclosure ideal for applications requiring protection against water ingress. The enclosure is manufactured polyurethane gasket that provides IP67 rating. Threaded brass inserts ensures reliable assembly of the enclosure.

Features and Benefits

- Made of ABS
- Available in light gray color
- Protection against liquids and solid objects: IP67 rating
- Protection against mechanical impacts: IK09 rating
- Supplied with silicon gasket and four screws
- Threaded brass inserts for reliable assembly.

rspro.com

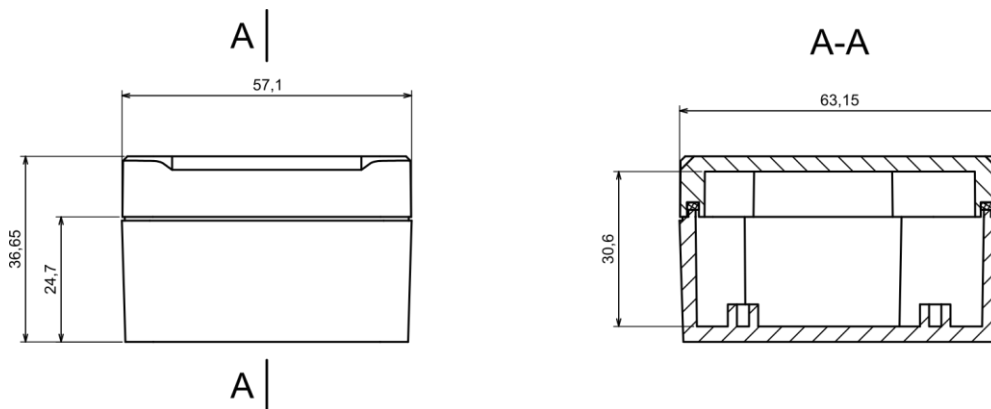

Category	Hermetically sealed Enclosures
Type	Full
Material	ABS
Variant	Hermetic (with polyurethane gasket) (S)
Height	36.7 mm
Width	57.1 mm
Length	63.2 mm
Color	Lightgray (J)
Protection level	IP67
Shock protection level	IK09
Standard Met	RoHS Compliant
Accessories	Screw M3/20: 4 pcs
Certificate number	CE/032/18



Max PCB size

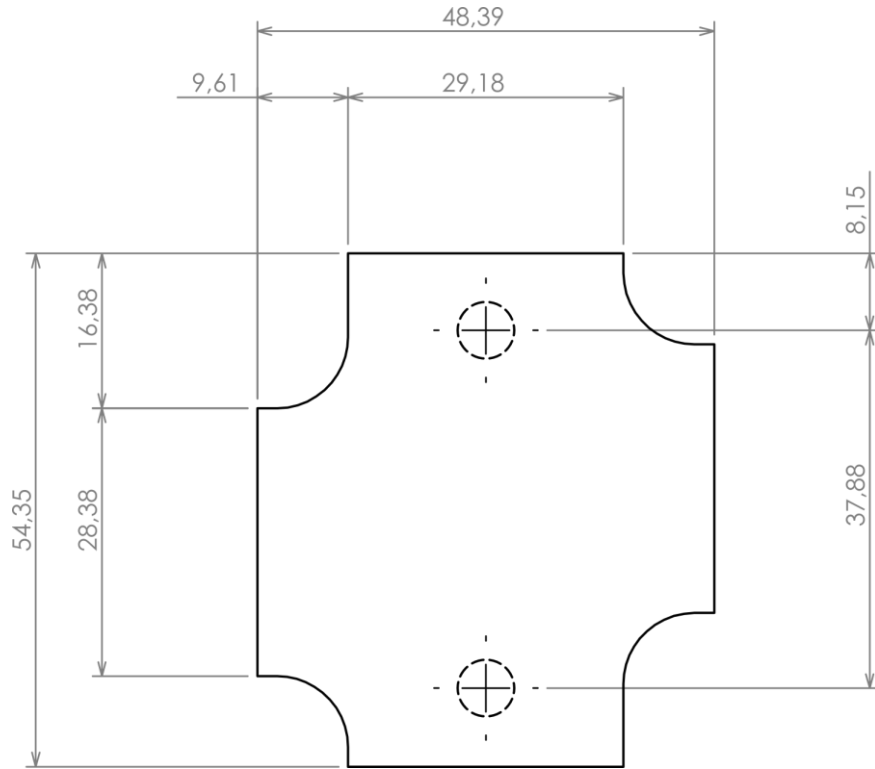

Dashed line shows outline of the mounting boss under PCB board
Recommended mounting holes diameter $\varnothing 3,5\text{mm}$