

Fubarino Mini

www.fubarino.org/Mini

A DIP form factor chipKIT® compatible board

By: Brian Schmalz and Rick Anderson
 licenced under Creative Commons v3.0 Attribution licence

If you like the Fubarino, please consider that SchmalzHaus can design a customized version for your specific needs.
 Contact brian@schmalzhaus.com for more information.

- v1.0 3/13/2012
- v1.1 4/4/2012
 - Switched green LED to sink to GND
 - Rotated 32KHz crystal so it lies flatter
 - Removed 32KHz crystal and caps from BOM
 - Added some pin numbers on top silk
- v1.2 6/8/2012
 - Separate out 5V_OUT and VIN
 - Swap GND and 5V_OUT/VIN so 5V_OUT/VIN are on end
 - Added in diodes to allow USB or external VIN power
- v1.3 7/17/2012
 - Extended CPU pads by .3mm for better reworkability
 - Changed power LED to red
- v1.4 7/18/2012
 - Switched CPU footprint to QFN44
 - C13 to 10uF for better 3.3V stability
- v1.5 02/25/2013 - Microchip version
 - Changed USB connector to Microchip standard
 - Added CE, RoSH, and chipKIT graphics to silk on back

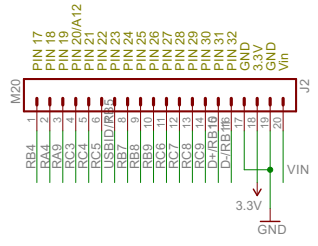
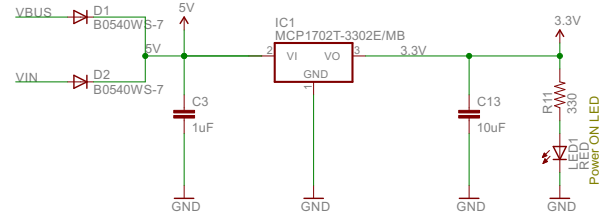
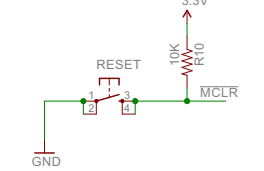
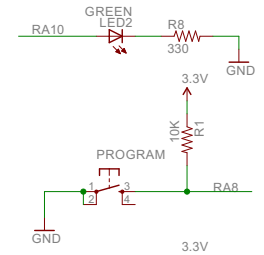
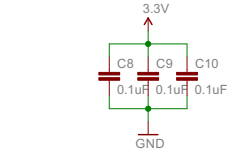
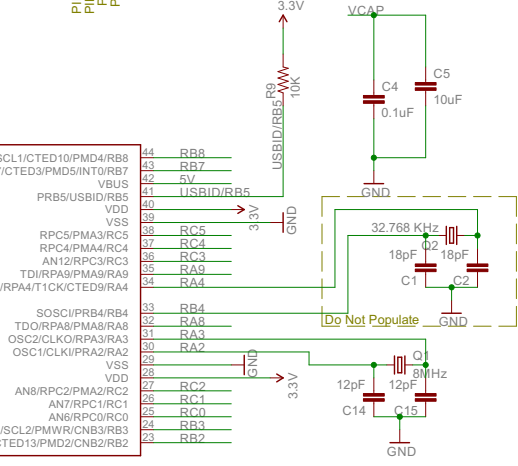
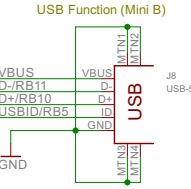
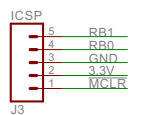
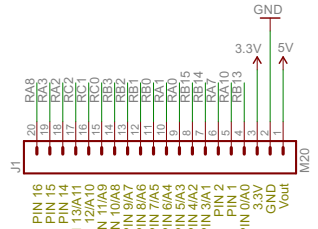

Copyright 2012 Brian Schmalz Copyright and related rights are licensed under the Solderpad Hardware License, Version 0.51 (the "License"); you may not use this file except in compliance with the License. You may obtain a copy of the License at <http://solderpad.org/licenses/SHL-0.51>. Unless required by applicable law or agreed to in writing, software, hardware and materials distributed under this License is distributed on an "AS IS" BASIS, WITHOUT WARRANTIES OR CONDITIONS OF ANY KIND, either express or implied. See the License for the specific language governing permissions and limitations under the License.



Title: FubarinoMini_v15	
Version:	
2/26/2013 8:18:08 PM	
Drawn By:	1/1