

KV Circuit breaker boxes with metric knockouts



- without terminals
- box walls without knockouts
- wall surface can be drilled individually for cable entry max. M50
- with two cable entries M 32 from the rear side
- "weatherproof" resistant to weather influences (UV due to solar radiation, protected against rainwater, temperature resistant, impact resistant, etc.)
- saltwater-proof
- "offshore applications"
- lid fasteners sealable without accessories
- external brackets for wall fixing included
- colour: grey, RAL 7035

wall thickness of the bottom part	2,7 mm
rated insulation voltage	$U_i = 1000 \text{ V a.c./d.c.}$
material	PC-GFS (polycarbonate)
degree of protection	IP 66 / IP 67 / IP 69 IP 67, temporary submersion up to 1 meter, max. 15 minutes IP 69, water pressure max. 100 bar, water temperature max. 80 °C, distance $\geq 0.15 \text{ m}$
mounting width	220 mm
mounting height	170 mm
max. installation depth	96 mm
width	255 mm
height	205 mm
depth	112 mm
weight	0,71 kg
in accordance with	IEC 60670-22
in accordance with	DNV GL - Certificate No: TAE0000EE Russian Maritime Register of Shipping, technical documentation is approved by the letter No. 250-A-1180-108795

Drawings

Dimension drawing

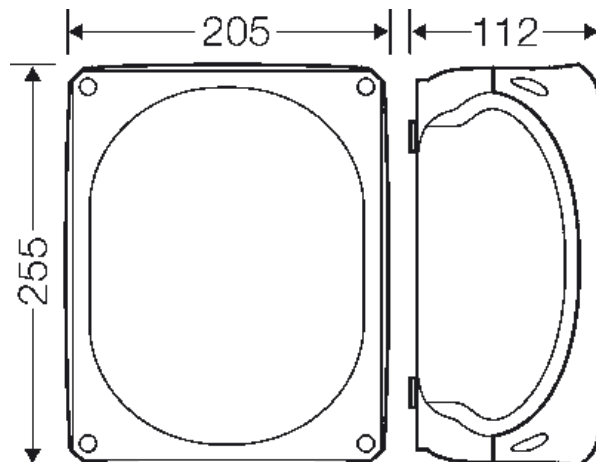

KV Circuit breaker boxes with metric knockouts



Detail mass

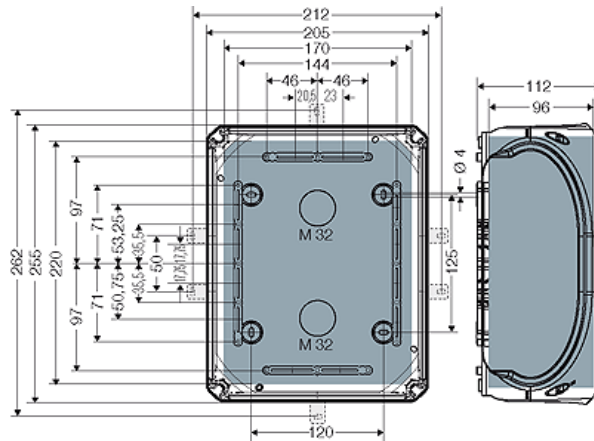

Box walls

Operating and ambient conditions

Application area	Suitable for outdoor installation (harsh environment and/or outdoor). To reduce the formation and accumulation of condensed water see technical information.
Resistant to occasional cleaning procedures (direct jet)	Resistance to occasional cleaning procedures (direct jet) with high-pressure cleaner without cleaning additives, water pressure: max 100 bar, water temperature: max 80 °C, distance ≥ 0.15 m, in accordance with DIN EN 60529:2014-09 (IEC 60529:2013) = IP 69.
Ambient temperature	Average value over 24 hours + 55 °C Maximum value + 70 °C Minimum value - 25 °C
Fire protection in the event of internal faults	Demands placed on electrical devices from standards and laws Minimum requirements - Glow wire test in accordance with IEC 60695-2-11: - 650°C for boxes and cable glands - 850°C for parts of insulating material necessary to retain current carrying parts in position
Burning behaviour	Glow wire test IEC 60695-2-11: 960 °C UL Subject 94: V-0 flame-retardant self-extinguishing
Degree of protection against mechanical load	IK09 (10 Joule)
Toxic behaviour	halogen-free silicone-free "halogen-free" in accordance with the examination of the cables and insulated wires - corrosiveness of fumes - as per IEC 60754-2
Note:	For material properties see technical data.