

Features

- 3 Pin Plug & Socket Set
- Cable to Cable Connections
- SY25 Series
- Screw
- Bayonet Coupling
- Cable Outer Diameter: 7-12mm
- Used in Factory Automation, Robotics, Industrial Machinery, Railway & Transportation, Aerospace & Defence, Medical Equipment, Renewable Energy Systems etc.

Product Description

RS PRO Industrial Circular Connectors

RS Stock No.: 0672249



RS PRO is the own brand of RS. The RS PRO Seal of Approval is your assurance of professional quality, a guarantee that every part is rigorously tested, inspected, and audited against demanding standards. Making RS PRO the Smart Choice for our customers.

The RS PRO range of industrial circular cable connectors is engineered for robust and reliable performance in demanding environments. Featuring a circular design for secure mating and easy installation, these connectors deliver outstanding protection against dust, moisture, and mechanical stress. This makes them an ideal choice for industrial automation, robotics, and outdoor applications where durability is critical. Designed to support both power and signal transmission, the connectors offer aesthetic consistency across your project by allowing a single series to be used for multiple functions.

General Specifications

Number of Contacts	3
Shell Material	Polycarbonate, Nylon66, fire resistance: V-0
Insert Material	Polyphenylene Sulphide (PPS)
Contact Material	Brass Alloy
Contact Plating	Gold
Pole Format	3P
Contact Gender	Male & Female
Mating Type	Bayonet
Mating Cycles	500
Colour	Black

Electrical Specifications

Plug/Socket	Plug & Socket
Termination	Screw
Current Rating	10A
Voltage Rating	500V
Insulation Resistance	$\geq 100M\Omega$
Contact Resistance	1m Ω Max

Mechanical Specifications

Connector Size	SY25
Contact Diameter	2.5mm

Cable Outer Diameter	7-12mm
Wire size (mm ² / AWG)	Min: 0.5 / 20 Max: 1.5 / 15

Operation Environment Specifications

Operating Temperature	-40°C to 85°C
-----------------------	---------------

Protection Category

IP Rating	IP67
-----------	------

Approvals

Compliance/Certifications	RoHS, CE
---------------------------	----------

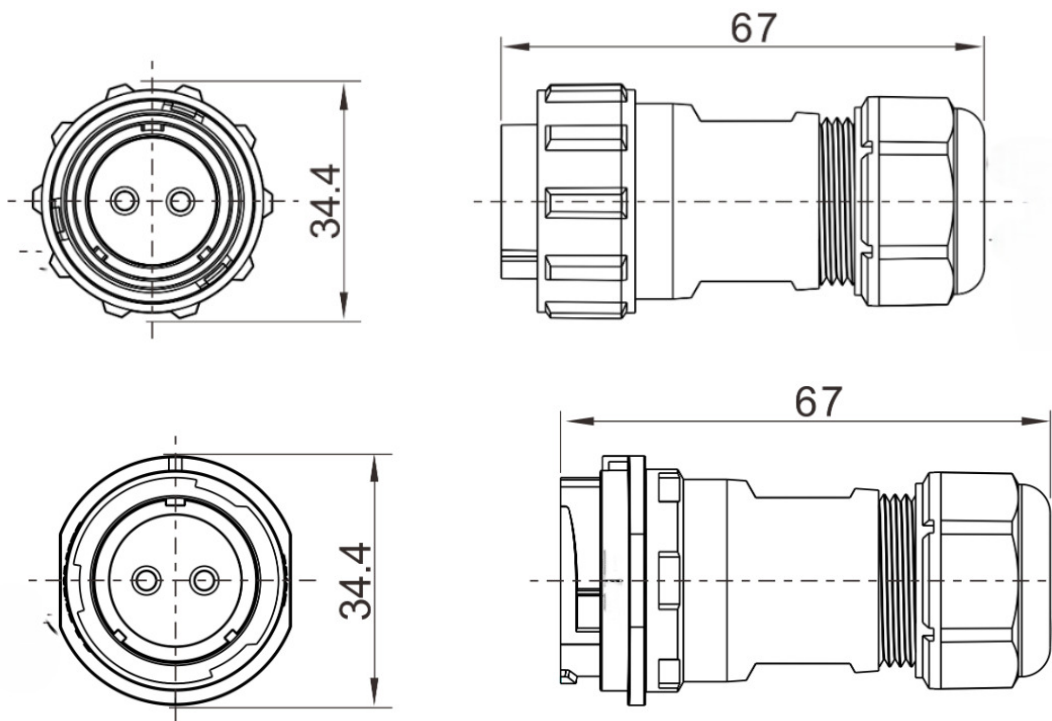

SCREW SPEC

SOLDER SPEC



Similar Products

Parameters	SY2510/P2II2NBN P&SY2511C/S2II2 CBNP	0672250	0672252	0672253
Number of Contacts	2	4	9	10
Current Rating	10	10	5 & 25	10
Voltage Rating	500	500	500	500
Termination Method	Screw	Screw	Solder	Solder
Wire size (mm²)	0.5-1.5	0.5-1.5	≤0.75 & ≤4	≤2
Contact Diameter	2.5mm	2.5mm	1 & 2.5mm	1.5mm

Parameters	0672254	0672255
Number of Contacts	12	19
Current Rating	10	5
Voltage Rating	500	400
Termination Method	Solder	Solder
Wire size (mm²)	≤2	≤0.75
Contact Diameter	1.5mm	1mm