

Switch disconnectors

A modular and flexible range



Contact gap
7 mm
(norm >5.5 mm)

**Reversible
terminal feature**

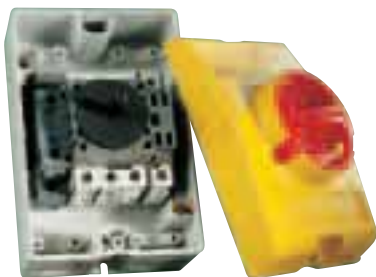

► IN ENCLOSURE

- Degree of protection: up to IP 66
- For 25A to 100A size switches (see lthe (A) p. 306)
- Cable entries with pre-formed knockouts
- Tamper-proof cover with padlockable handle
- Recessed area for optional plate
- A wide choice of associated contact blocks and enclosures versions available

Pages 289 and 295

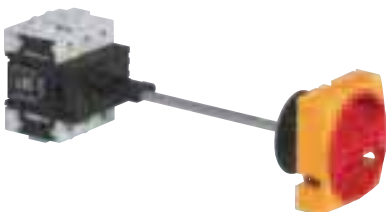

► WITH CLUTCH DRIVE

- Metal cuttable shafts
- With or without door interlock system
- Short or long metal shaft available

Pages 288 and 293

Complete switch disconnectors 20 A

IP 40 as standard, IP 65 on request

 Characteristics (p. 306)

▶ FRONT MOUNTING

PADLOCKABLE PRESENTATION

Cat. No.



172921

20 A - non-reversible terminals

3P
3P+NC/NO(1)
4P

172901
172911
172921

(1) Padlock with \varnothing 6 to 8 mm

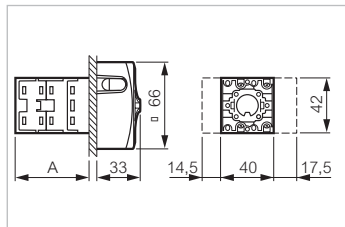

Dimensions

A: 46 (3P/4P)
56 (3P+NC/NO)

ACCESSORIES

Cat. No.



172945

IP65 seal kit

For front mounting with screws

172945

Terminal covers

For front mounting with screws

172965

Complete switch disconnectors 25 to 100 A

IP 40 as standard, IP 65 on request

 Characteristics (p. 306)

FRONT MOUNTING

PADLOCKABLE PRESENTATION

Cat. No.

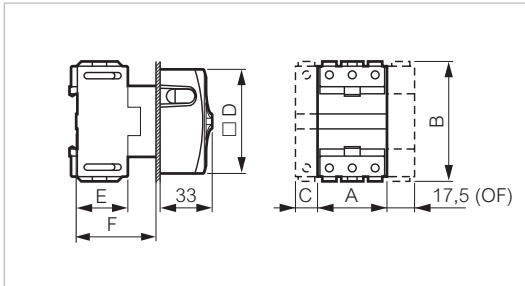

Safety switch to disconnect and isolate poles.
 IP 20 "finger safe"
 Double break type load switching
 Red padlockable handle on yellow plate
 Actual position (ON or OFF) clearly visible
 Conform to standards:
 IEC EN 60947-3
 Approved by UL - cUL – Suitable as motor disconnect



172001

Dimensions	
A:	44
B:	75.4
C:	14.5
D:	□ 66
E:	36
F:	50

25 A	
3P	172001
3P+NC/NO ⁽¹⁾	172011
4P neutral on left	172021



172201

Dimensions	
A:	53.6
B:	85
C:	17.9
D:	□ 66
E:	50.3
F:	60

32 A	
3P	172101
4P neutral on left	172121

50 A	
3P	172201
4P neutral on left	172221



172401

Dimensions	
A:	71.8
B:	93
C:	26.8
D:	□ 86
E:	63.8
F:	70

63 A	
3P	172301
4P neutral on left	172321

80 A	
3P	172401
4P neutral on left	172421

100 A	
3P	172501

(1) Padlock: ϕ 6 to 8 mm

Complete switch disconnectors 25 to 100 A

IP 40 as standard, IP 65 on request

 Characteristics (p. 306)

FRONT MOUNTING

WITH PLATE, FRAME AND HANDLE

Cat. No.

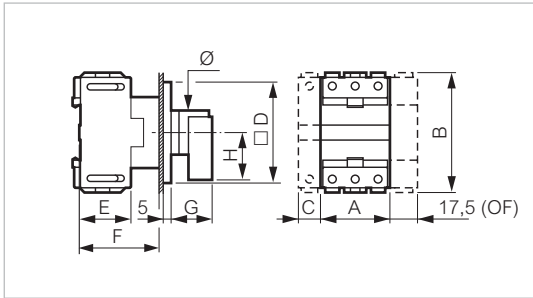

Safety switch to disconnect and isolate poles.
 IP 20 "finger safe"
 Double break type load switching
 Red handle on yellow plate
 Actual position (ON or OFF) clearly visible
 Conform to standards:
 IEC EN 60947-3
 Approved by UL - cUL – Suitable as motor disconnect



172002

Dimensions	
A:	44
B:	75.4
C:	14.5
D:	□ 64
E:	36
F:	50
G:	26
H:	22
∅:	28

25 A

3P

172002

32 A

3P

172102



172202

Dimensions	
A:	53.6
B:	85
C:	17.9
D:	□ 72
E:	50.3
F:	60
G:	26
H:	30
∅:	28

50 A

3P

172202

63 A

3P

172302



172402

Dimensions	
A:	71.8
B:	93
C:	26.8
D:	□ 96
E:	63.8
F:	70
G:	31
H:	34
∅:	42

80 A

3P

172402

100 A

3P

172502

Complete switch disconnectors 25 to 100 A

IP 40 as standard, IP 65 on request

 Characteristics (p. 306)

▶ FRONT MOUNTING

PADLOCKABLE PRESENTATION Ø 22 SINGLE-HOLE MOUNTING

Cat. No.

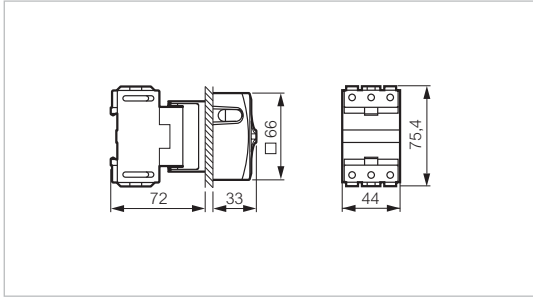

Safety switch to disconnect and isolate poles.
 IP 20 "finger safe"
 Double break type load switching
 Red handle on yellow plate
 Actual position (ON or OFF) clearly visible
 Conform to standards:
 IEC EN 60947-3
 Approved by UL - cUL – Suitable as motor disconnect

25 A

3P

172003

32 A

3P

172103



172003

Complete switch disconnectors 25 to 100 A

IP 40 as standard, IP 65 on request

 Characteristics (p. 306)

► REAR MOUNTING WITH CLUTCH DRIVE

PADLOCKABLE PRESENTATION

Cat. No.

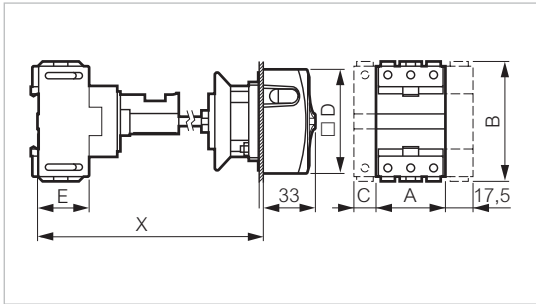

Safety switch to disconnect and isolate poles.
 IP 20 "finger safe"
 With clutch drive and door interlock
 Double break type load switching
 Red handle on yellow plate
 Actual position (ON or OFF) clearly visible
 Conform to standards:
 IEC EN 60947-3
 Approved by UL - cUL – Suitable as motor disconnect

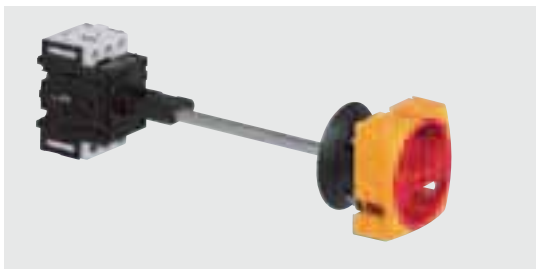

165009

25 A	
3P	165009
32A	
3P	165109

25 and 32 A dimensions

A: 44
 B: 75.4
 C: 14.5
 D: □ 66
 E: 31.5
 X: 125 to 250 (short shaft)
 250 to 400 (long shaft)

50 and 63 A dimensions

A: 53.6
 B: 85
 C: 17.9
 D: □ 66
 E: 42.2
 X: 135 to 260 (short shaft)
 260 to 410 (long shaft)

50 A	
3P	165209
63 A	
3P	165309

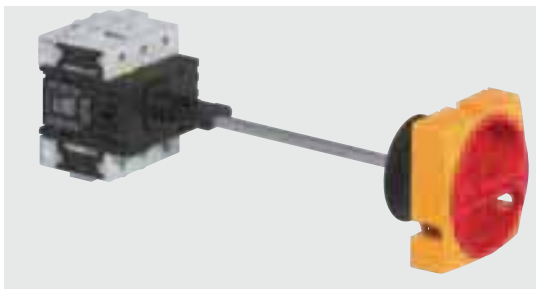

165409

80 A	
3P	165409
100 A	
3P	165509

80 and 100 A dimensions

A: 71.8
 B: 93
 C: 26.8
 D: □ 86
 E: 52.6
 X: 145 to 270 (short shaft)
 270 to 420 (long shaft)

Complete switch disconnectors 25 to 100 A

IP 40 as standard, IP 65 on request
and IP 66 on enclosure version with integral handle version

 Characteristics (p. 306)

► ENCLOSURES

INTEGRAL PADLOCKABLE PRESENTATION

Cat. No.

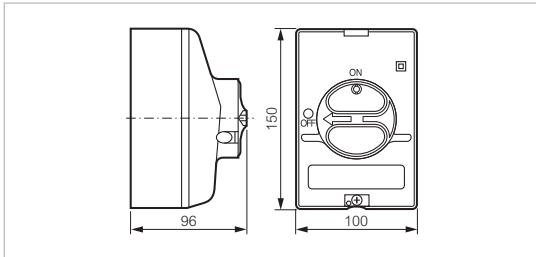

Safety switch to disconnect and isolate poles.
IP 20 “finger safe”
With clutch drive and door interlock
Double break type load switching
Red handle on yellow plate
Actual position (ON or OFF) clearly visible
Conform to standards:
IEC EN 60947-3



172061

IP 66 - IK 7

20 A

3P	172961
3P+NC/NO ⁽¹⁾	172971
4P	172981

25 A

3P	172061
3P+NC/NO ⁽¹⁾	172071

32 A

3P	172161
----	---------------

PADLOCKABLE PRESENTATION

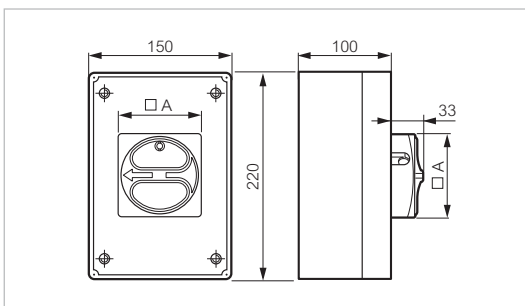

IP 40 ⁽²⁾

50 A

3P	172261
----	---------------

63 A

3P	172361
----	---------------

80 A

3P	172461
----	---------------

100 A

3P	172561
----	---------------

(1) Padlock: Ø 6 to 8 mm
(2) IP 65 seal kit ref. 172267 (50 to 63 A)
172277 (80 to 100 A)



172261

50 and 63 A dimensions

A: 66

80 and 100 A dimensions

A: 86

Complete switch disconnectors 20 A

IP 40 as standard, IP 65 on request
Grey presentation

 Characteristics (p. 306)

▶ FRONT MOUNTING

PADLOCKABLE PRESENTATION

Cat. No.



174901

20 A - non-reversible terminals
3P

174901

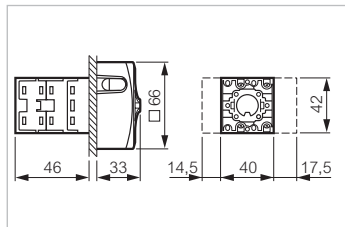

ACCESSORIES

Cat. No.



172945

IP 65 seal kit
For front mounting with screws

172945

Terminal covers
For front mounting with screws

172965

Complete switch disconnectors 25 to 100 A

IP 40 as standard, IP 65 on request
Grey presentation

▶ FRONT MOUNTING

 Characteristics (p. 306)

PADLOCKABLE PRESENTATION

Cat. No.

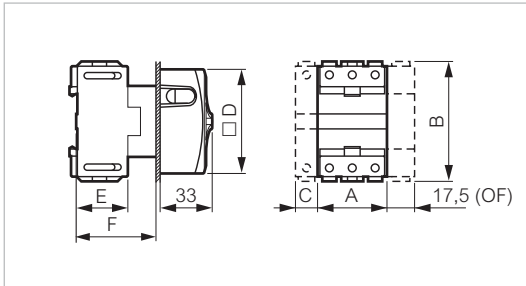

Safety switch to disconnect and isolate poles.
IP 20 “finger safe”
Double break type load switching
Grey padlockable handle on grey plate
Actual position (ON or OFF) clearly visible
Conform to standards:
IEC EN 60947-3
Approved by UL - cUL – Suitable as motor disconnect

25 A

3P

174001



174001

Dimensions	
A:	44
B:	75.4
C:	14.5
D:	□ 66
E:	36
F:	50

32 A

3P

174101



174301

Dimensions	
A:	53.6
B:	85
C:	17.9
D:	□ 66
E:	50.3
F:	60

63 A

3P

174301



174401

Dimensions	
A:	71.8
B:	93
C:	26.8
D:	□ 86
E:	63.8
F:	70

80 A

3P

174401

100 A

3P

174501

(1) Padlock: \varnothing 6 to 8 mm

Complete switch disconnectors 25 to 100 A

IP 40 as standard, IP 65 on request
Grey presentation

 Characteristics (p. 306)

FRONT MOUNTING

WITH PLATE, FRAME AND HANDLE

Cat. No.

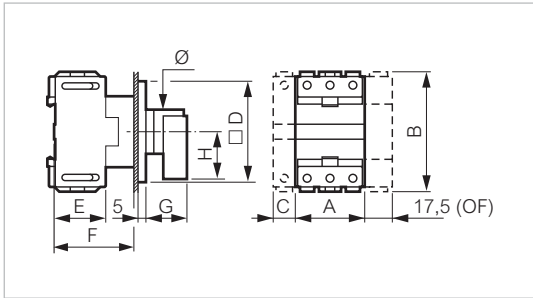

Safety switch to disconnect and isolate poles.
IP 20 "finger safe"
Double break type load switching
Black handle on aluminium plate
Actual position (ON or OFF) clearly visible
Conform to standards:
IEC EN 60947-3
UL - cUL approved – Suitable as motor disconnect

25 A

3P

174002

32 A

3P

174102

50 A

3P

174202

63 A

3P

174302

80 A

3P

174402

100 A

3P

174502



174002

Dimensions

A: 44
B: 75.4
C: 14.5
D: □ 64
E: 36
F: 50
G: 26
H: 22
Ø: 28



174202

Dimensions

A: 53.6
B: 85
C: 17.9
D: □ 72
E: 50.3
F: 60
G: 26
H: 30
Ø: 28



174402

Dimensions

A: 71.8
B: 93
C: 26.8
D: □ 96
E: 63.8
F: 70
G: 31
H: 34
Ø: 42

Complete switch disconnectors 25 to 100 A

IP 40 as standard, IP 65 on request
Grey presentation

► REAR MOUNTING

 Characteristics (p. 306)

PADLOCKABLE PRESENTATION

Cat. No.

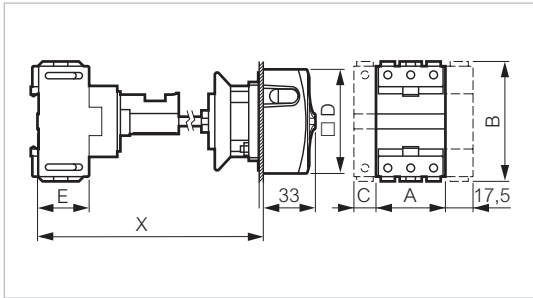

Safety switch to disconnect and isolate poles.
IP 20 "finger safe"
With clutch drive and door interlock
Double break type load switching
Grey padlockable handle on grey plate
Actual position (ON or OFF) clearly visible
Conform to standards:
IEC EN 60947-3
Approved by UL - cUL – Suitable as motor disconnect

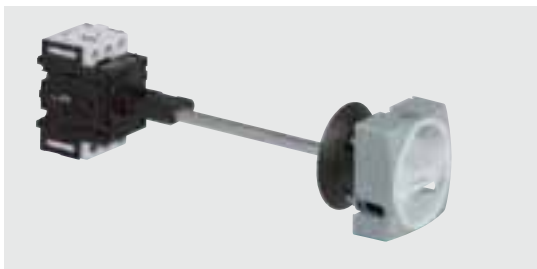

165009

25 A

3P

168009

32A

3P

168109

25 and 32 A dimensions

A: 44
B: 75.4
C: 14.5
D: □ 66
E: 31.5
X: 125 to 250 (short shaft)
250 to 400 (long shaft)

50 and 63 A dimensions

A: 53.6
B: 85
C: 17.9
D: □ 66
E: 42.2
X: 135 to 260 (short shaft)
260 to 410 (long shaft)

50 A

3P

168209

63 A

3P

168309

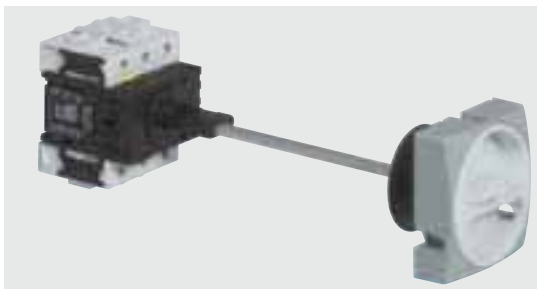

165409

80 A

3P

168409

100 A

3P

168509

80 and 100 A dimensions

A: 71.8
B: 93
C: 26.8
D: □ 86
E: 42.6
X: 145 to 270 (short shaft)
270 to 420 (long shaft)

Complete switch disconnectors 25 to 100 A

IP 40 as standard, IP 65 on request
Grey presentation

 Characteristics (p. 306)

► REAR MOUNTING

MODULAR IN-PANEL PRESENTATION

Cat. No.

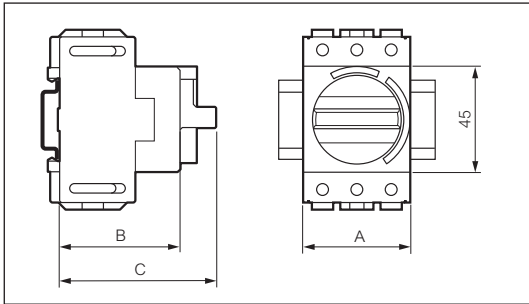

Safety switch to disconnect and isolate poles.
IP 20 "finger safe"
Double break type load switching
Black handle on grey plate
Actual position (ON or OFF) clearly visible
Conform to standards:
IEC EN 60947-3
Approved by UL - cUL – Suitable as motor disconnect

25 A

3P

174005

32 A

3P

174105

50 A

3P

174205

63 A

3P

174305

80 A

3P

174405

100 A

3P

174505



174005

Dimensions
A: 44
B: 53
C: 79



174205

Dimensions
A: 53.6
B: 63
C: 89



174405

Dimensions
A: 71.8
B: 73
C: 99

Complete switch disconnectors 25 to 100 A

IP 40 as standard, IP 65 on request and
IP66 on enclosure version with integral handle version
Grey presentation

► ENCLOSURES

 Characteristics (p. 306)

INTEGRAL PADLOCKABLE PRESENTATION

Cat. No.

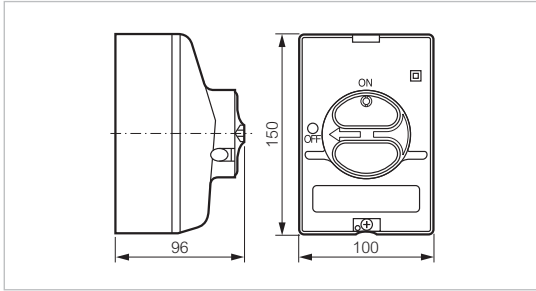

Safety switch to disconnect and isolate poles.
IP 20 “finger safe”
With clutch drive and door interlock
Double break type load switching
Grey padlockable handle
Actual position (ON or OFF) clearly visible
Conform to standards:
IEC EN 60947-3

IP 66 - IK 7

25 A
3P

174061

32 A
3P

174161



174061

PADLOCKABLE PRESENTATION

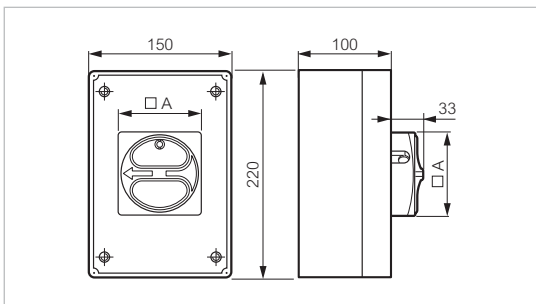

IP 40 (1)

50 A
3P

174261

63 A
3P

174361

80 A
3P

174461

100 A
3P

174561

(1) IP 65 with seal ref. 172267 (50 to 63 A)
172277 (80 to 100 A)



174261

50 and 63 A dimensions

A: □ 66

80 and 100 A dimensions

A: □ 86

Separate switch disconnectors - 25 and 32 A

 Characteristics (p. 306)

► BLOCKS

Cat. No.



172000

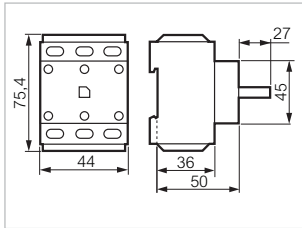

3 pole switch body without presentation

25 A
32 A

172000
172100



172065

172185

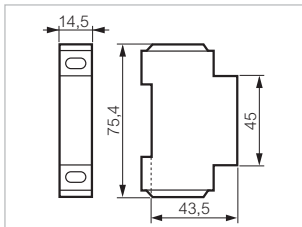

Additional pole
(for use in enclosure only)

25 A
32 A

172075
172175

Neutral pole

25 A
32 A

172065
172165

Junction block

⊥ or N

172185

Auxiliary contact

NC/NO

172179



172179

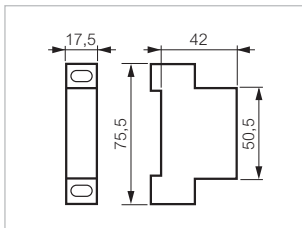

1 pole early break

172195

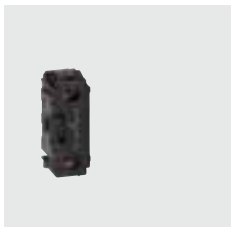

172195

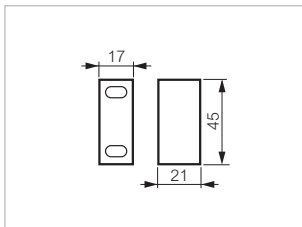

Separate switch disconnectors - 25 and 32 A

► PRESENTATION

 Characteristics (p. 306)

Cat. No.

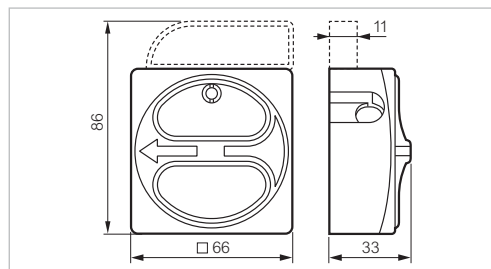

Padlockable presentation

Padlock with $\varnothing 6$ to 8 mm
with additional NC/NO

- 66 - Yellow/Red
- 66 - Grey
- 66 - $\varnothing 22$ single-hole-mounting - Yellow/Red

172601
174601
172603



172601

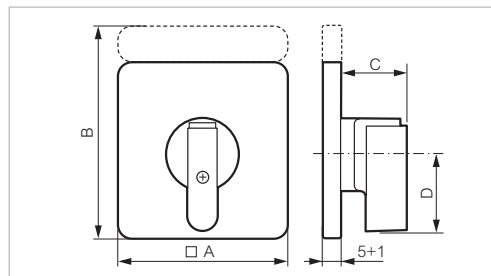

With plate, frame and handle

- 64 - Yellow/Red
- 48 - $\varnothing 22$ single-hole-mounting - Yellow/Red

172602
172604



172602

Dim. Ref. 172 602

A: 64

B: 80

Dim. ref. 172 604

A: 48

B: 65

Separate switch disconnectors - 25 and 32 A

 Characteristics (p. 306)

▶ EMPTY ENCLOSURES

PADLOCKABLE PRESENTATION

Cat. No.



172399

Dimensions 150 x 100 x 96 mm
 Supplied with padlockable handle,
 weatherproof seal and relay terminal
 For 3 and 4 pole switches
 with and without NC/NO

IP66-IK7

Grey base - yellow cover - red handle
 Grey base - grey cover - grey handle

172399
174399

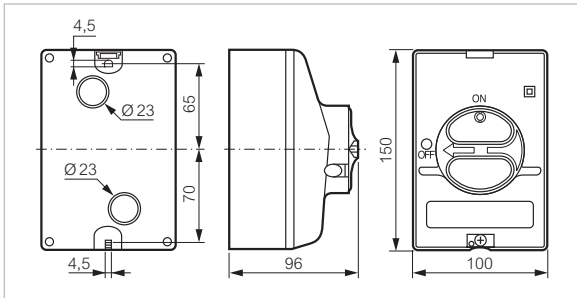

WITHOUT PRESENTATION

Cat. No.



172549

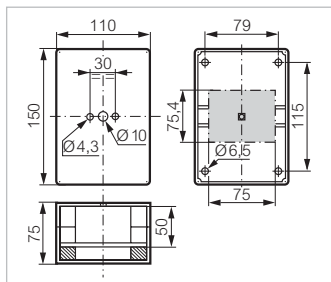

Grey - Up to 4 poles + auxiliary contact
 150 x 110 x 75 mm

172549

PADLOCKABLE OR WITHOUT PRESENTATION

Cat. No.



172559

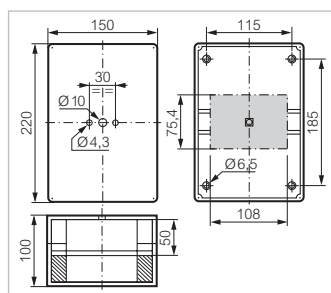

Grey - Up to 6 poles + auxiliary contact
 220 x 150 x 100 mm

172559

Separate switch disconnectors - 25 and 32 A

▶ ACCESSORIES

 Characteristics (p. 306)

Cat. No.



172167

Terminal covers

- For 3 pole body switch **172167**
- For additional pole, neutral pole or junction block **172177**
- For auxiliary contact NC/NO (pair) **172189**
- For early break auxiliary contact **172199**



174569

Connection terminal kit

- Terminal connection for ground or neutral **174449**

Self-adhesive plates (for enclosures)

- Blank **174599**
- Engraved INTER PRINCIPAL **174559**
- Engraved MAIN SWITCH **174569**



174189

Duty labels

- Blank **172629**
- Engraved INTER PRINCIPAL **172639**
- Engraved MAIN SWITCH **172649**



172177

Kit for clutch drive presentation

- Short shaft without door interlock **174189**
- Long shaft without door interlock **174199**
- Without shaft and without door interlock **174179**

Kit for door interlock

174249

IP 65 seal kit

For front mounting switches and enclosures

- Padlockable 66
- or plate and frame 64 or 72 **172267**
- Padlockable 86
- or plate and frame 96 **172277**

For rear mounting switches with clutch drive

- Padlockable 66
- or plate and frame 64 or 72 **174259**
- Padlockable 86
- or plate and frame 96 **174269**

Separate switch disconnectors - 50 and 63 A

 Characteristics (p. 306)

► BLOCKS

Cat. No.



172300

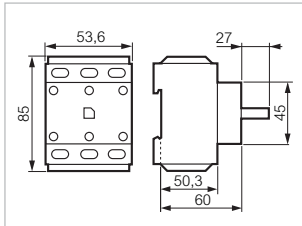

3 pole body switch without presentation

50 A
63 A

172200
172300

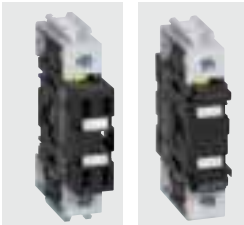

172375

172385

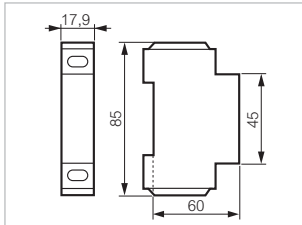

Additional pole
(for use in enclosure only)

50 A
63 A

172275
172375

Neutral pole

50 A
63 A

172265
172365

Junction block

⊥ or N

172385



172179

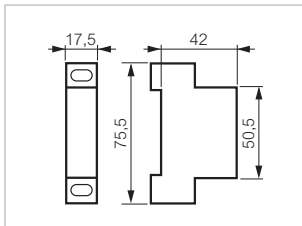

Auxiliary contact

NC/NO

1 pole early break

172179

172395



172395

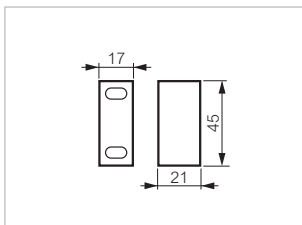

Separate switch disconnectors - 50 and 63 A

► PRESENTATION

 Characteristics (p. 306)

Cat. No.



172061

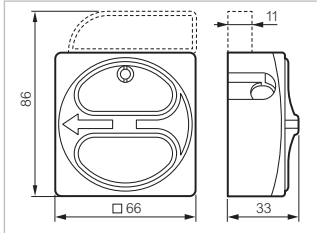

Padlockable presentation
Padlock: \varnothing 6 to 8 mm
with additional auxiliary contacts NC/NO

- 66 - Yellow/Red
- 66 - Grey

172601
174601



172612

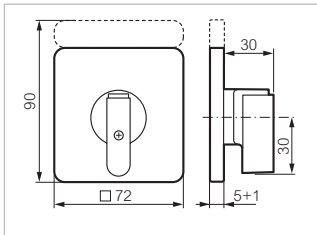

With plate, frame and handle

- 72 - Yellow/Red

172612

► EMPTY ENCLOSURES

WITHOUT PRESENTATION

Cat. No.



172569

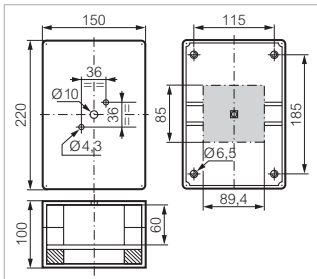

Grey - Up to 4 poles + auxiliary contact
220 x 150 x 100 mm

172569



172579

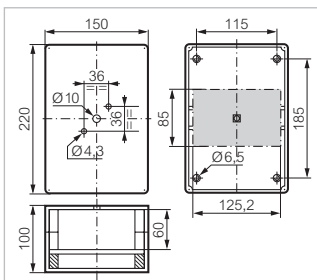



Grey - Up to 6 poles + auxiliary contact
220 x 150 x 100 mm

172579

Separate switch disconnectors - 50 and 63 A

 Characteristics (p. 306)

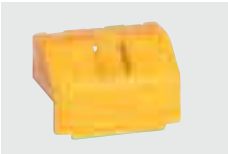
▶ ACCESSORIES

	Cat. No.
 172367	<p>Terminal covers</p> <p>For 3 pole switch 172367 For additional pole, neutral pole or junction block 172377 For NC/NO auxiliary contact (pair) 172189 For early break auxiliary contact 172199</p>
 172649	<p>Duty labels</p> <p>Blank 172629 Engraved INTER PRINCIPAL 172639 Engraved MAIN SWITCH 172649</p>
 172267	<p>Kit for clutch drive presentation</p> <p>Short shaft without door interlock 174189 Long shaft without door interlock 174199 Without shaft and without door interlock 174179</p> <p>kit for door interlock 174249</p> <p>IP 65 seal kit</p> <p>For front mounting switches and enclosures</p> <p>Padlockable <input type="checkbox"/> 66 or plate and frame <input type="checkbox"/> 64 or <input type="checkbox"/> 72 172267 Padlockable <input type="checkbox"/> 86 or plate and frame <input type="checkbox"/> 96 172277</p> <p>For rear mounting with clutch drive</p> <p>Padlockable <input type="checkbox"/> 66 or plate and frame <input type="checkbox"/> 64 or <input type="checkbox"/> 72 174259 Padlockable <input type="checkbox"/> 86 or plate and frame <input type="checkbox"/> 96 174269</p>

Separate switch disconnectors - 80 and 100 A

► BLOCKS

 Characteristics (p. 306)

Cat. No.



172400

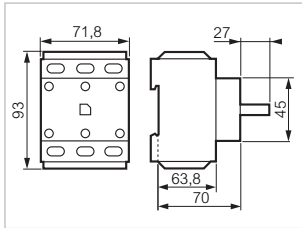

3 pole body switch without presentation

80 A
100 A

172400
172500



172475



172465

Additional pole
(for use in enclosure only)

80 A
100 A

172475
172575

Neutral pole

80 A
100 A

172465
172565



172585

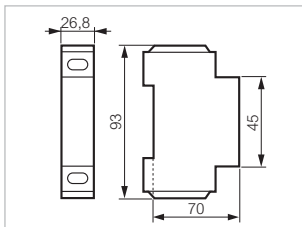

Junction block

⊥ or N

172585



172179

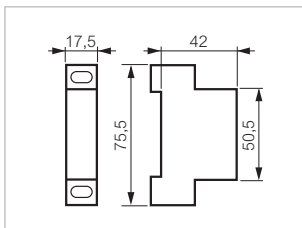

Auxiliary contact

NC/NO

172179

1 pole early break

172595

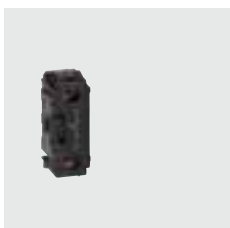

172595

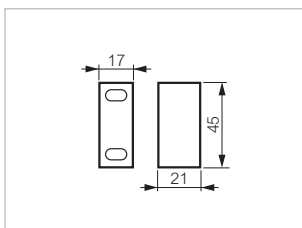

Separate switch disconnectors - 80 and 100 A

 Characteristics (p. 306)

PRESENTATION

Cat. No.



172621

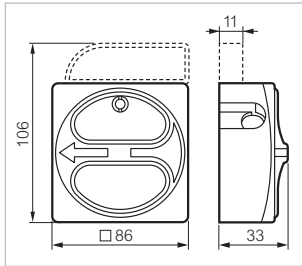

Padlockable presentation
 Padlock: \varnothing 6 to 8 mm
 with additional auxiliary contacts NC/NO
 86 - Yellow/Red
 86 - Grey

172621
174621



172622

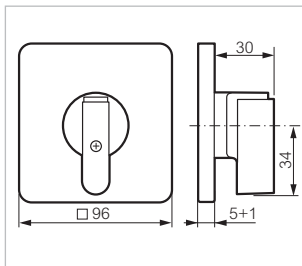

With plate, frame and handle
 96 - Yellow/Red

172622

EMPTY ENCLOSURES

WITHOUT PRESENTATION

Cat. No.



172589

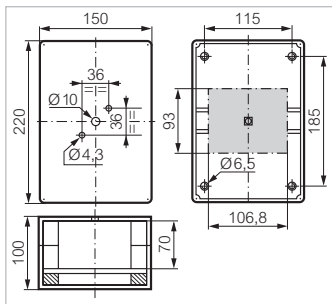

Grey - Up to 3 poles + auxiliary contact
 220 x 150 x 100 mm

172589



172599

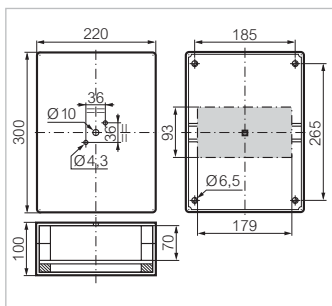



Grey - Up to 6 poles + auxiliary contact
 300 x 200 x 100 mm

172599

Separate switch disconnectors - 80 and 100 A

 Characteristics (p. 306)

▶ ACCESSORIES

		Cat. No.
 172567	Terminal covers	
	For 3 pole body switch	172567
	For additional pole, neutral pole or junction block	172577
	For NC/NO auxiliary contact (pair)	172189
	For early break auxiliary contact	172199
 172649	Duty labels	
	Blank	172629
	Engraved INTER PRINCIPAL	172639
	Engraved MAIN SWITCH	172649
 172267	Kit for clutch drive presentation	
	Short shaft without door interlock	174189
	Long shaft without door interlock	174199
	Without shaft and without door interlock	174179
	kit for door interlock	174249
	IP 65 seal kit	
	For front mounting switches and enclosures	
	Padlockable <input type="checkbox"/> 66 or plate and frame <input type="checkbox"/> 64 or <input type="checkbox"/> 72	172267
	Padlockable <input type="checkbox"/> 86 or plate and frame <input type="checkbox"/> 96	172277
	For rear mounting with clutch drive	
	Padlockable <input type="checkbox"/> 66 or plate and frame <input type="checkbox"/> 64 or <input type="checkbox"/> 72	174259
	Padlockable <input type="checkbox"/> 86 or plate and frame <input type="checkbox"/> 96	174269

Technical characteristics

► GENERAL

Characteristics	20 A	25 A	32 A	50 A	63 A	80 A	100 A
► Rated insulation voltage U_i (V)	690	690	690	690	690	690	690
► Conventional free air thermal current I_{th}							
Uninterrupted rated current I_u (A)	20	25	32	50	63	80	100
► Conventional enclosed thermal current I_{the} (A)	16	20	25	40	50	63	80
► Rated impulse withstand voltage (overvoltage category III - pollution degree 3 U_{imp} (kV)	4	6	6	6	6	6	6
► Rated operating current I_e (A) AC - 21 A/22 A Conform to IEC 60947-3	16	25	32	50	63	80	100
► Rated operating power (kW)							
AC 23 A 3 x 230 V	4	5.5	5.5	15	15	18.5	22
3 x 400 V	7.5	7.5	11	18.5	22	30	37
3 x 500 V	5.5	7.5	11	22	30	37	45
3 x 690 V	4	7.5	11	18.5	22	22	30
AC 3 3 x 230 V	3	4	4	7.5	11	15	18.5
3 x 400 V	4	5.5	7.5	15	18.5	22	30
3 x 500 V	5.5	5.5	7.5	15	22	30	37
3 x 690 V	3	5.5	7.5	15	18.5	18.5	22
► Make - break characteristics (A_{eff}/400 V)							
Rated make capacity	-	710	710	1270	1270	1970	1970
Rated break capacity	-	330	330	800	800	800	800
► Short circuit characteristics							
Rated short term withstand current I_{cw} (A _{eff} /400 V/1 s)	250	350	430	500	760	1100	1500
Rated short circuit make capacity I_{cm} (kA peak/400 V)	-	1	1	1.8	1.8	2.8	2.8
Short circuit current (kA I_{eff} /400 V)	6	10	10	10	10	10	10
with fuse gI/gG (A)	16	25	32	50	63	80	100
► Mechanical life AC 20 (million)	1	0.1	0.1	0.04	0.04	0.04	0.04
► Connections							
Stranded wire + (min/max) cap (mm ²)	0.75/2.5	0.75/6	0.75/6	1.5/16	1.5/16	2.5/35	2.5/35
Solid wire (mm ²)	4	10	10	25	25	50	50
► Storage temperature	-30°C TO +70 °C						
► Operating temperature	- 30°C TO +70 °C						
► Protection rating	rear of panel: IPxxB front of panel IP 40 in standard version (IP 65 on request)						
► Conformity to standards	IEC 60697-3 -EN 60 947-3, UL508, CSA22.2						
► Approvals	UL - cUL (USA - Canada) suitable as motor disconnect. CB certification						
► Climatic resistance	Tropical atmosphere according to IEC 60068-2-30 Cyclic damp heat						

Technical characteristics

▶ AUXILIARY CONTACTS

Characteristics	20 A	25 A	32 A	50 A	63 A	80 A	100 A
▶ Rated insulation voltage U_i (V)	400	400	400	400	400	400	400
▶ Conventional free air thermal current I_{th}							
Continuous rated current I_u (A)	20	10	10	10	10	10	10
▶ Rated operating current I_e (A)							
AC 15							
230 V	6	6	6	6	6	6	6
400 V	-	4	4	4	4	4	4
▶ PROTECTION AGAINST SHORT CIRCUIT BY FUSE gG (A)	16	10	10	10	10	10	10
▶ Max. connection stranded wire (mm ²)	2 x 2.5	2 x 2.5	2 x 2.5	2 x 2.5	2 x 2.5	2 x 2.5	2 x 2.5

▶ ENCLOSURES

Characteristics	150x100x96	220x150x100	220x150x100	220x150x100	220x150x100	300x200x100
▶ Rating	20, 25 and 32 A 3P to 4P +NC/NO 20 A - 6P	25 and 32 A 6P and 6P +NC/NO	50 and 63 A 3P to 4P +NC/NO	50 and 63 A 6P and 6P +NC/NO	80 and 100 A 3P and 3P +NC/NO	80 et 100 A 4P to 6P +NC/NO
▶ Cable inputs	2 x 2 Pg 16 OR 2 x 2 M25	2 x 2 Pg 21	2 x 2 Pg 21	2 x 2 Pg 29	2 x 2 Pg 29	2 x 2 Pg 21 and 2 x 2 Pg 29
▶ Ø knockouts (mm)	Pg 16: 22.5 ISO M25: 25	28.5	28.5	37.5	37.5	37.5 and 28.5
▶ No. of knockouts (top and bottom)	2	2	2	2	2	4
▶ Panel mount	by 2 screws	by 4 screws				
▶ Base/cover assembly	by 1 screws self-tapping stainless steel	by 4 screws self-tapping stainless steel				by 6 screws self-tapping stainless steel
▶ Switch/base assembly	on 35 mm DIN rail (this rail is notched for positioning the switch)					
▶ Handles mounting	screwing on shaft pre-pierced cover					
▶ Insulation	Class II installed (provided that the correct insulation plugs are used with the enclosure)					
▶ Impact withstand	IK07					
▶ Flameproof	650°C					
▶ Protection rating	IP 66		IP 40 (IP 65 upon request)			
▶ Contact operating diagram						
▶ Switch padlocking	In general: up to 3 padlocks \varnothing 4 to 8 mm Switch with 1 auxiliary contact NC/NO: up to 3 padlocks \varnothing 6 to 8 mm Modular presentation: 1 padlock \varnothing 6 to 8 mm					

Enclosure selection guide

► 25 AND 32 A



Example: switch disconnector 32 A
Enclosed 4 pole,
padlockable presentation

Enclosure 150 x 100 x 96 mm

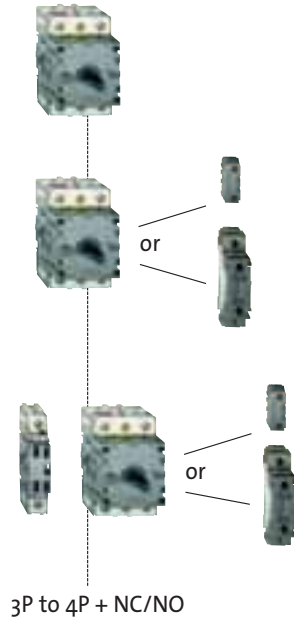

Enclosure 220 x 150 x 100 mm

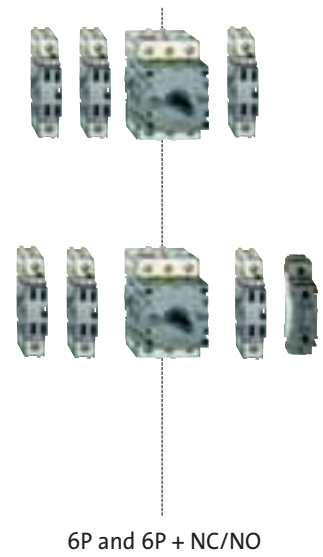

► 50 AND 63 A



Example: switch disconnector 50 A
Enclosed 6 pole,
Plate, frame and handle presentation

Enclosure 220 x 150 x 100mm

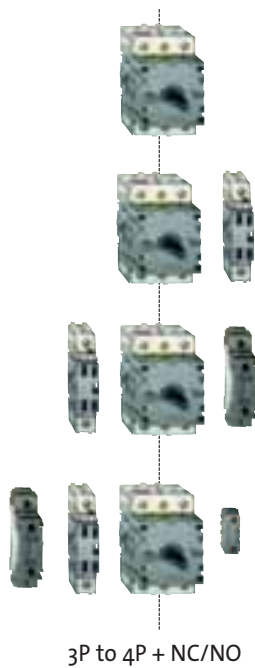

Enclosure 220 x 150 x 100 mm

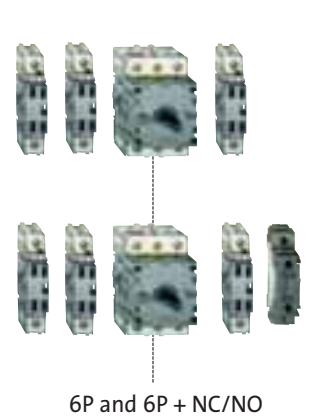

Enclosure selection guide

▶ 80 AND 100 A

Enclosure 220 x 150 x 100 mm

Enclosure 300 x 220 x 100 mm



Example: switch disconnector 100 A
Enclosed 4 pole,
padlockable presentation

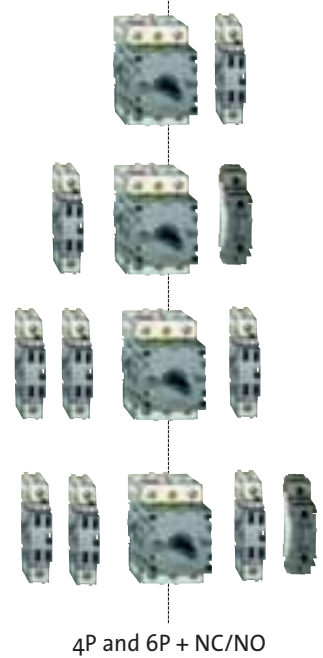

LEGEND



basic 3 pole block



additional pole
additional neutral pole
junction block



Auxiliary contact NC/NO



early break auxiliary contact

Possible configurations

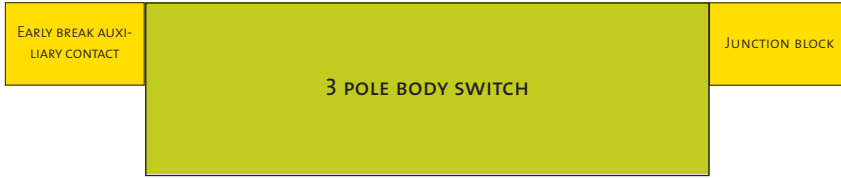

OR

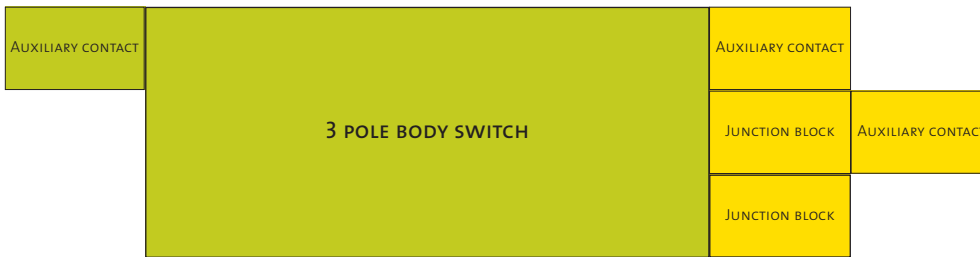

OR



OR

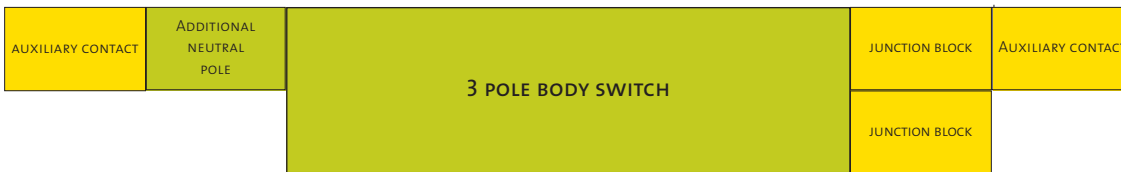

OR

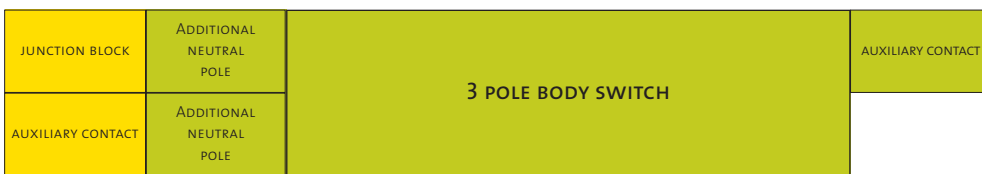

OR

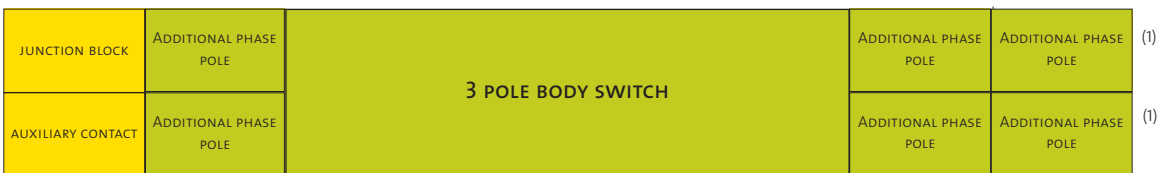

(1) version with enclosure only

- Complete switch disconnecter p. 284 to 295
- Permitted auxiliaries



BACO[®]

www.baco-international.com

