



ENGLISH

Datasheet

RS Pro 7 Digit, LCD, Digital Counter, 40Hz, 9 → 30 V dc

Stock Number: 896-6992



FEATURES :

- Suitable for Hour meter & Counter (Up / Down) application
- Wide Hour meter range from 1 sec to 9999999 hrs.
- Wide counter range from 1 to 9999999 counts.
- Prescaling facility for Counter.
- Alarm facility for both Hour meter & Counter.
- MOSFET Output with Over Load detection.
- Retentive & Non-Retentive modes.
- 7 Digit LCD with luxurious green backlight.
- Compact size.
- Suitable for panel mounting.

Proximity Switch Connection Diagram:

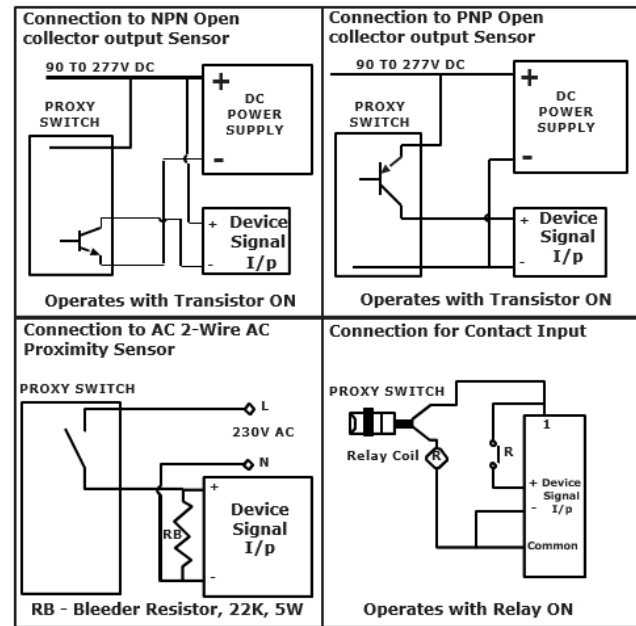



Using MOSFET O/P as signal I/P to External system

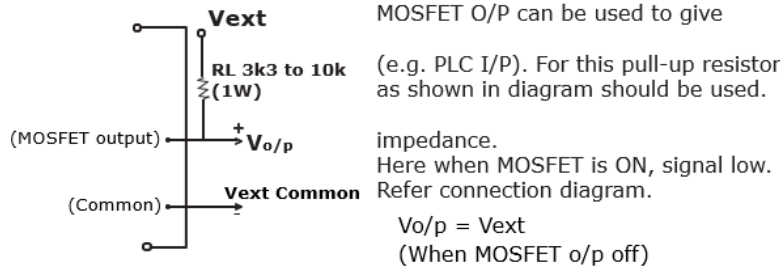

Overall Product Dimensions & Mounting Details (in mm)

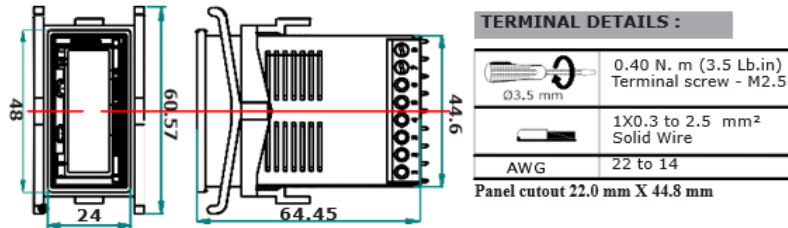

FRONT VIEW:

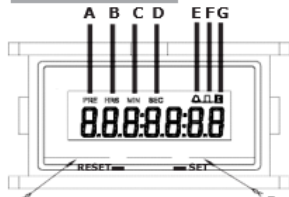

SYMBOL MEANING :

Symbol	Meaning
	Hourmeter - Blinking symbol means signal present.
	Counter - Product is in counter mode.
	Still symbol- Alarm is configured Blinking symbol- At alarm value reached.
PRE	Prescaler - Prescaler greater than 1 is selected.

- H A - Prescaler
- B - Hour
- C - Minute
- D - Second
- E - Alarm
- F - Counter
- G - Hour Meter Symbol
- H - RESET(RST)
- I

Following devices are also available in scope of GIC P. Ltd,
Z2121N0G1FT00 - DCHM, 90-277 VAC/DC, MOSFET OUTPUT
Z2001N0G1FT00 - DCHM, 7-60 VDC, MOSFET OUTPUT

FREQUENTLY ASKED QUESTIONS :

Q1. How can I change the device mode from Counter to Hour Meter or vice versa ?

Ans: To change the device mode from counter to hour meter or vice versa , it is required to reset the device, then in edit mode select the respective mode.

Q2. How to Reset the Counter/Hour meter, if 'Reset' is disabled?

Ans: If user disables Reset and save the setting, after that again user enables reset then only Terminal reset option is available to user. User has to enable the terminal reset, then reset the device count/time by shorting terminal reset pin & common ground pin. After this only user will see all reset settings in Edit menu .

Q3. What should I do when device flashes the Roll over message?

Ans: This means, device display limit is rolled over, then reset the count/time or change the resolution. Screen 50

Q4. What should I do when device flashes the Over load message?

Ans: This means, that device output MOSFET is over loaded, Press SET key for 3sec to see the normal screen & make sure that connected load current should not be greater



Supply Characteristics :				
Supply Voltage Range (Un)		9 to 30 VDC	85 to 265 VAC/VDC	
Power Consumption		2 Wat max.	2VA / 1W	
Supply Frequency		50/60 Hz		
I/P Signal Characteristics :				
Signal Voltage Range		9 to 30 VDC VDC	85 to 265 VAC & 100 to 265 VDC	
Signal Isolation				
Output Characteristics :				
Output type		2MOSFET:30 VDC/60 mA(Max.) Note:Use isolated input supply	Relay: 1 C/O, Contact Rating: 5 A(Res.)@250 VAC/30VDC Contact Material: Ag Alloy	
Functional Characteristics :				
Display		7 digit LCD , 6.5 mm Height, 12 O' Clock, Transmissive		
Number of keys		2 (SET key & RST key)		
Reset function		Reset type	Terminal	Front
		Time(min.)	80 ms	3 Sec
				Auto Reset
				-
Hour Meter Functions	Accuracy	+/- 2 Sec per day		
	Ranges	Hrs : Min : Sec (999:59:59), Hrs : Min (99999:59), Hrs (9999999), Min (9999999), Sec (9999999)		
Counter Functions	Accuracy	100 %		
	Range	1 to 9999999.999		
	Decimal Point Position(max.)	3		
	Pre-scaler	4-Digit		
	Input Signal	Switching Freq.(max.)	10 Hz for AC and 40 Hz for DC	
		Pulse Width min.	50ms ON/50ms OFF for AC, 12.5ms ON/12.5ms OFF for DC	
Environmental Characteristics :				
Operating Temperature		-5° C to +55° C		
Storage Temperature		-10° C to +60° C		
Humidity		5 to 95% Rh (Without condensation)		
Maximum Operating Altitude		2000 m		
Pollution Degree		II		
Degree of Protection		Front side: IP40; Terminals: IP20, Housing : IP30		
Enclosure material		UL 94 V0 Plastic		
Casing color		Black		

Other Characteristics :	
Mounting	Flush mounting on panel cut-out
Panel Cut-out	22mm X 44.8mm
Weight (Un-packed)	52 gm
Operating Position	Horizontal
Termination wire Sizes	Wire size : 22-14 AWG, 0.3-2.5 mm
EMI/EMC Compliance:	
Harmonic Current Emissions	IEC 61000-3-2 Ed. 4.0 (2014-02) Class A
Voltage Flicker & Fluctuation	IEC 61000-3-3 Ed. 3.0 (2013-05) Class A
ESD	IEC 61000-4-2 Ed. 2.0 (2008-12) Level II
Radiated Susceptibility	IEC 61000-4-3 Ed. 3.2 (2010-04) Level III Criteria B
Electrical Fast Transients(Supply)	IEC 61000-4-4 Ed. 3.0 (2012-04) Level IV
Electrical Fast Transients(Signal)	IEC 61000-4-4 Ed. 3.0 (2012-04) Level III
Surge	IEC 61000-4-5 Ed. 2.0 (2005-11) Level III
Conducted Susceptibility	IEC 61000-4-6 Ed. 4.0 (2013-10) Level III
Power Frequency Magnetic Field	IEC 61000-4-8 Ed. 2.0 (2009-09) Class 4
Voltage Dips	IEC 61000-4-29 Ed. 1.0 (2000-08) Class B
Conducted Emission	CISPR 11 Ed. 5.1 (2010-05) Class A
Radiated Emission	CISPR 11 Ed. 5.1 (2010-05) Class A
Safety Compliance:	
Test Voltage (All terminal to housing)	IEC 60947-5-1 Ed. 3.1 (2009-07) 2.5 kV
Single fault	IEC 61010-1 Ed. 3.0 (2010-06)
Leakage Current	UL 508 Ed. 17 (1999-01) <3.5 mA
Environmental Compliance :	
Cold Heat	IEC 60068-2-1 Ed. 6.0 (2007-03)
Dry Heat	IEC 60068-2-2 Ed. 5.0 (2007-07)
Vibration	IEC 60068-2-6 Ed. 7.0 (2007-12) 5 g
Repetitive Shock	IEC 60068-2-27 Ed. 4.0 (2008-02) 40 g, 6 ms
Non-repetitive Shock	IEC 60068-2-27 Ed. 4.0 (2008-02) 30 g, 15 ms



To enter in edit mode, Press SET & RESET key simultaneously for 3 sec. Product firmware version is displayed for 500ms and then Scr 1 is displayed.

Hour Meter Flow :-

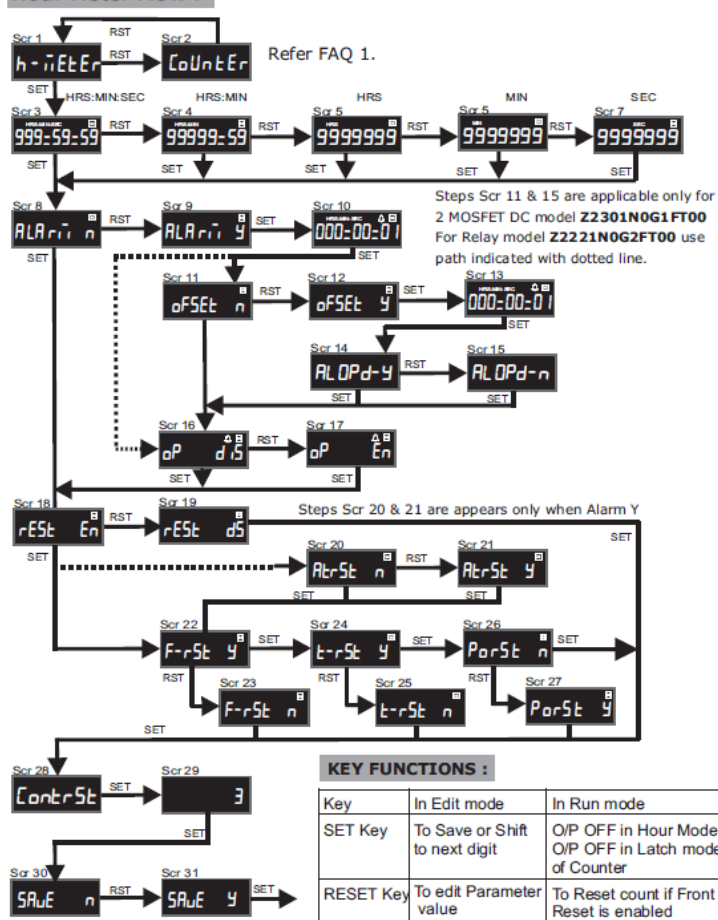

Mode selection :-

Set Hour meter mode as per required resolution. Refer (Scr 3 to Scr 7)
If the resolution is changed in RUN mode then hour meter shows time change as per selected mode.

Alarm value selection :-

To set alarm value Press SET key to select each digit & press RESET key to edit the digit, Press SET key. The next digit starts blinking, after modifying last digit all digits starts blinking. Press SET to set the Alarm time. Refer Scr 8 to Scr 10

Note: Alarm is of recurring type alert. Recurring alert occurs continuously at a predefined period. It is Start to Start type.

After changing Alarm value, if new Alarm value less than Current value then, output will turn on at display value equal to (Current value + alarm value). If new alarm value is greater than current display value, then output turns when alarm value is reached.

Alarm output dependency:

Alarm output dependency: This is the dependency of offset output with alarm output. If ALOPd Y is selected then, Offset output is acknowledged before turning ON the alarm output, then alarm output will not turn ON when alarm value is reached. If ALOPd n is selected then alarm output will turn ON at alarm value reached.

Refer Scr 11 to Scr 13

Offset value selection:

Offset value should not be greater than or equal to Alarm value. While editing the offset value, care has been taken to avoid the selection of such value. i.e. If offset value is greater than or equal to Alarm value then it will not accept. Refer Scr 14 to Scr 15

Output Enable / Disable :-

Using this setting output can be made either enabled Or disabled. Refer Scr 16 to Scr 17

Reset Enable / Disable :-

Device can be reset through 4 different ways. Reset Disable - Device will set as non-resettable. Refer Scr 18 to Scr 27.

Auto reset allows user to reset Time or Count Automatically if ALrSt - Y. Auto reset is enable, if Alarm value is enable.

For Counter: - If output type is Latch, then device will reset after pressing RESET key. If output type is time out, then device will reset after time out.

For Hour meter:- Device will reset hour meter after pressing RESET key.

Front reset allows user to reset Time or Count by pressing RST key for 2 sec.

Terminal reset allows user to reset Time or Count by shorting reset terminal to ground for minimum 80 mS .

Power ON reset: PorSt n - Count / time retains at power ON. PorSt y - Count / time resets at power ON

Contrast control :-

Using this function contrast level of LCD can be adjusted from 0 to 7. Refer Scr 28 & Scr 29

Save :- Confirmation to save edited parameter. Refer Scr 30 to Scr 31.

Save Y - Saves the edited parameter in memory.

Save N - It will not save edited parameters.



Counter Flow:- Auto reset is not applicable for Down counter.

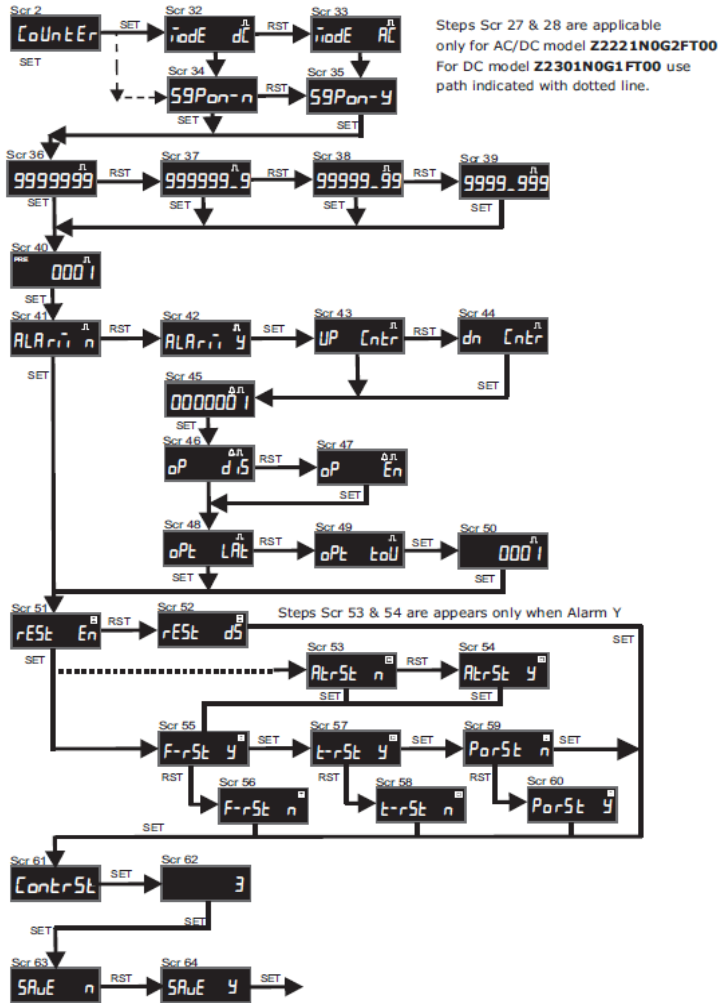

Input signal selection:

Note: This part is applicable for AC-DC product only. Refer Scr 32 & Scr 33.

Mod dc for DC signal selection. Mod AC for AC signal selection.

59Pon-n - There is no increment in count if signal is present at power ON.

59Pon-y - Increments the count if signal is present at each power ON. Refer Scr 34 & Scr 35.

Decimal point selection:-

Four decimal point position selection available. Refer Scr 36 to Scr 39.

Prescaler :-It means number of pulses required to increment display value by 1.

User has to select Decimal point position(Resolution) as per prescaler value set.

e.g. Lets say if application is of bottle counting & 10 bottles per box. So select Prescaler as 10, Set decimal point as 1, then after 10 pulses, it increments display value by 1 and for one pulse, it increments display by 0.1.

If the same application is considered as 125 bottles per box, then select prescaler as 125, Set decimal point as 3, then after 125 pulses it increments display value by 1 and for one pulse, it increments display by 0.008. Refer Scr 40

Alarm value selection :-

Refer Scr 41 to Scr 45.

Up counter functionality is recurring alarm type, output turns on every time after alarm value reaches & it continues the counting.

Down counter functionality is Preset type. It starts from alarm value & when value reaches to zero output turns on. Auto reset is not applicable for Down counter.

Note:

After changing Alarm value, if new Alarm value less than Current value then, out put turns on at display value equal to (Current value + alarm value). If new alarm value is greater than current display value then, output turns on at alarm value.

Output Enable / Disable :-

Using this setting output can be made either enabled Or disabled.

Refer Scr 46 to Scr 47.

NOTE :

When output is enabled, MOSFET output turns ON when alarm value is reached.

When output is disabled, MOSFET output remains OFF even when alarm value is reached.

Alarm symbol blinks when alarm value reaches, irrespective of output enabled/disabled.

Output Type :- There are two type of output functionality. Refer Scr 48 to Scr 50.

Latch

Once Alarm Value reaches, Output becomes ON & remains ON until it gets acknowledged.

It also retains its state after power OFF/ON cycle.

Time out

When output turns ON it remains ON till the timeout period, which is in seconds.

Timeout value can be set from 1 to 9999

After this screen for Reset types, Contrast & setting same Screen 18 to 31 will appear in order.

Note:-

In counter for 1,2,3 decimal point, when display value is greater than 7 digit, then device will show "Rollover". If device shows rollover then select the lower decimal point position. In No decimal point - after rollover value will reset to zero.

Over load condition for Two MOSFET :-

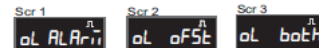

In output ON condition, when over load condition is occurs then "oL ALARn" or "oL ofSE.." is displayed in two MOSFET device only,output is turned Off. Press SET key to normal screen or device will go to RUN mode after TIMEOUT period.

When both output are ON and both at over load condition then "oL both" screen will occurs