



MICRO SWITCH™
Compact Precision Limit Switches
914CE Series



MICRO SWITCH™ 914CE Series

Compact Precision Limit Switches

All MICRO SWITCH™ 914CE Series compact enclosed switches incorporate fluorocarbon diaphragm sealing to provide reliable protection, meeting NEMA 1, 2, 3, 3R, 4, 6, 6P, and 13 as well as IP66, IP67, and IP68 requirements. Versions with boot seal also meet NEMA 12 requirements (dust, falling dirt, liquid media with solid contaminants). The cable or connector and basic switch terminals are encapsulated in an epoxy sealant, offering excellent resistance in harsh environments. For low temperature applications (down to -40 °C, -40 °F), CE Series switches can be supplied with low temperature seals and lubricant.

The CE Series switches are rugged and versatile switches which can be applied indoors in many harsh factory floor applications, as well as on outdoor equipment in extreme temperatures. A full range of actuators are available, including plain plungers, roller plungers, side rotary, multi-directional wire, and manually operated. The switches are also available with the industry standard, M12 micro-change 4-pin connector. MICRO SWITCH™ 914CE products meet North American, cURus standards, as well as European CE requirements.

What makes our switches better?

- Compact construction for minimal real estate on equipment
- Gang mounting capability to provide a multi-plunger limit switch
- Rugged, die-cast zinc housing for many demanding environments
- Variety of cable length options and choice of side or bottom exit cable/connector for design flexibility
- Functionality over a wide temperature range with factory sealed connectors or wiring



Big performance in a little package.

CUSTOMIZATION • COMPACT
HIGH PERFORMING • DURABILITY



Features and Benefits

RUGGED, COMPACT CONSTRUCTION

MICRO SWITCH™ 914CE Series limit switches' compact construction means **minimal real estate on equipment**. Delivers consistent performance in many demanding environments where petroleum, synthetic or water based fluids are present. Its die-cast zinc housing and fluorocarbon diaphragm maintain a tightly sealed, NEMA 1, 2, 3, 3R, 4, 6, 6P, 12 (boot seal), and 13 IP66/67/68 rugged package.

Gang-mounting option

CUSTOMIZATION

Switches are **pre-leaded** (UL cable) or supplied with a **M12 four-pin connector** to decrease installation time. 914CE Series' wide selection of actuators **minimize installation or time issues**. Cable length variations for equipment requiring different cable lengths with side and bottom exit cable/connector options for equipment flexibility.

COMPACT DESIGN

Rugged, compact switch with a **25 mm hole-hole mounting** footprint. Engineered with a MICRO SWITCH™ SM switch for **consistent, precise actuation**.

High performance switch for small spaces

LONG LIFE

Well suited for up to **10 million actuation cycles**. (Up to 5 million actuation cycles for wobble actuators)

DESIGN FLEXIBILITY

Gang mounting capability to provide a **multi-plunger limit switch**. **Low temperature variants** available for indoor and outdoor applications.

GLOBAL APPLICATIONS

cURus, CE approvals for world-wide use.

Potential Applications



MACHINE TOOLS

Detects tool and piece part location on CNC and other machining equipment

OFF-ROAD EQUIPMENT

Used as a cab door switch on crane booms

MATERIAL HANDLING

Used in dock locks for trucks and trailers, and vehicle wash systems



ACCESS AND MOBILITY SOLUTIONS

Often used on vehicle wheelchair lifts and stairway lifts

TEXTILE MACHINERY

Senses roll size, tensioning, and other functions

ROBOTICS

Controls arm movement limits



PACKAGING EQUIPMENT

Often used on stretch pallet wrapping equipment

COMMERCIAL APPLIANCES

Functions as a door switch

PRINT TRADE MACHINERY

Senses roll size, tensioning, along with controlling gates and panels

AGRICULTURAL MACHINERY

Used on grain and livestock equipment

MICRO SWITCH™ Compact Precision Limit Switches

Table 1. Specifications

Characteristic	Parameter
Description	compact enclosed limit switch
Actuators	<ul style="list-style-type: none"> • Top pin plunger (914CE1-) • Cross roller plunger (914CE3-) • Top pin plunger with boot seal (914CE18-) • Wobble (914CE20-) • Top pin plunger, panel mount (914CE27-) • Top roller plunger, parallel and panel mount (914CE28-) • Top roller plunger, perpendicular, panel mount (914CE29-) • Top roller plunger, parallel & boot sealed (914CE31-) • Top roller plunger, perpendicular, boot seal (914CE55-) • Parallel roller plunger (914CE2-) • Front rotary (914CE16-) • Top adjustable plunger (914CE19-) • Manually operated (914CE22-) • Ball bearing plunger (914CE66-)
Terminations	SJTO 4 x 0,75 mm ² (18 AWG) cable Connector (dc), 4-pin male, M12 thread (-Q), (-Q2) Revised pin-out, see page 6 Connector (ac), 4-pin male, 1/2 in x 20 thread (-Q1)
Switching options	SPDT, snap action contacts (1NC/1NO)
Sealing	IP66, IP67, IP68 (depending upon model) NEMA 1, 2, 3, 3R, 4, 6, 6P, 12 (boot seal), 13
Operating temperature	0 °C to 105 °C [32 °F to 221 °F] optional -40 °C to 105 °C [-40 °F to 221 °F] Rotary: -40° C to 100 °C [-40 °F to 212 °F]
Mechanical life	up to 10 million (up to 5 million for wobbles)
Thermal current	1 A, 3 A, 5 A (depending upon model)
Rated Insulation voltage (Ui)	250 V
Rated impulse withstand voltage (Uimp)	1.5 kV
Pollution degree	3
Min. actuation speed	0.003 m/s
Max. actuation speed	0.1 m/s
Max. actuation frequency	ac – 200 Hz; dc – 20 Hz
Shock	50 g – IEC68-2-27
Vibration	10 G – IEC68-2-6
Approvals	cURus, CE
Conforming to standards	IEC947-5-1, EN 60947-5-1; AC14 D300, DC13 R300 UL recognized to US and Canadian Requirements

Table 2. Electrical Ratings (in amperes)

Model example	Contacts	Rating
914CE* - *	Silver contacts	A
914CE* - *G	Gold contacts	B
914CE* -Q, -AQ, -AQ1, -Q2	Silver contacts	C with 4-pin connector

Rating code	Electrical rating	Make	Break
A	cURus, CE	240 Vac, ind.	1.2
		240 Vac, res.	5
		28 Vdc, res.	3
		28 Vdc, ind.	3
		5 A, 1/10 HP, 125 Vac or 250 Vac	–
B	cURus, CE	1 A res., 0.5 A ind., 30 Vdc	–
		1 A, 125 Vac	–
C	cURus, CE	3 A, 125 Vac or 250 Vac	–

914CE Series

SWITCHING AND LEAD IDENTIFICATION

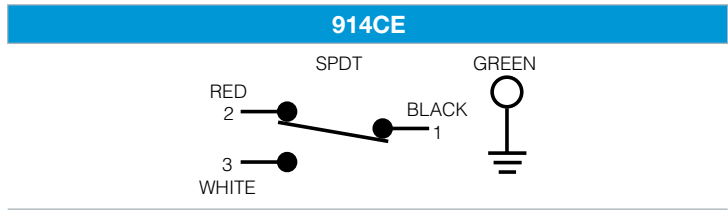

PINOUTS

Connector - (dc) (-Q)	Connector (dc) (-Q2)	Connector (ac) (-Q1)

CONNECTOR VERSIONS

The 914CE Series is available with a 4-pin, M12 size connector in both bottom and side exit versions.

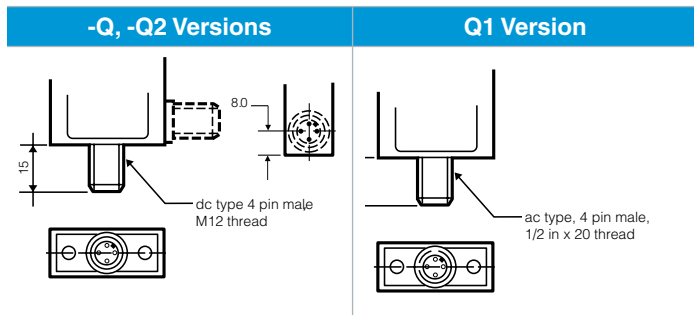

MOUNTING

MICRO SWITCH™ 914CE Series switches are mounted by using two M5 or #10 screws. The mounting holes are counter bored to keep the screw heads within the overall switch housing dimensions.

GANG MOUNT CAPABILITY

The housing on the 914CE Series has been designed to enable the user to build his own multiple plunger switch by gang mounting several switches. All pin plunger and roller plunger types are suitable for gang mounting. There is a 16 mm distance between the plungers. Both series are very versatile that even a lever-type version could be added at the end of the row.

BOTTOM EXIT OR SIDE EXIT ORIENTATION

The CE Series has been designed with a pre-wired cable fitted in the bottom of the switch housing. Other variations are available with a side exit cable.

GOLD CONTACT VERSIONS

For low energy applications (up to 30 Vdc, 1 A), gold contact versions of the 914CE switches can be supplied upon request.

MICRO SWITCH™ Compact Precision Limit Switches

GENERAL DIMENSIONS • ALL SWITCHES

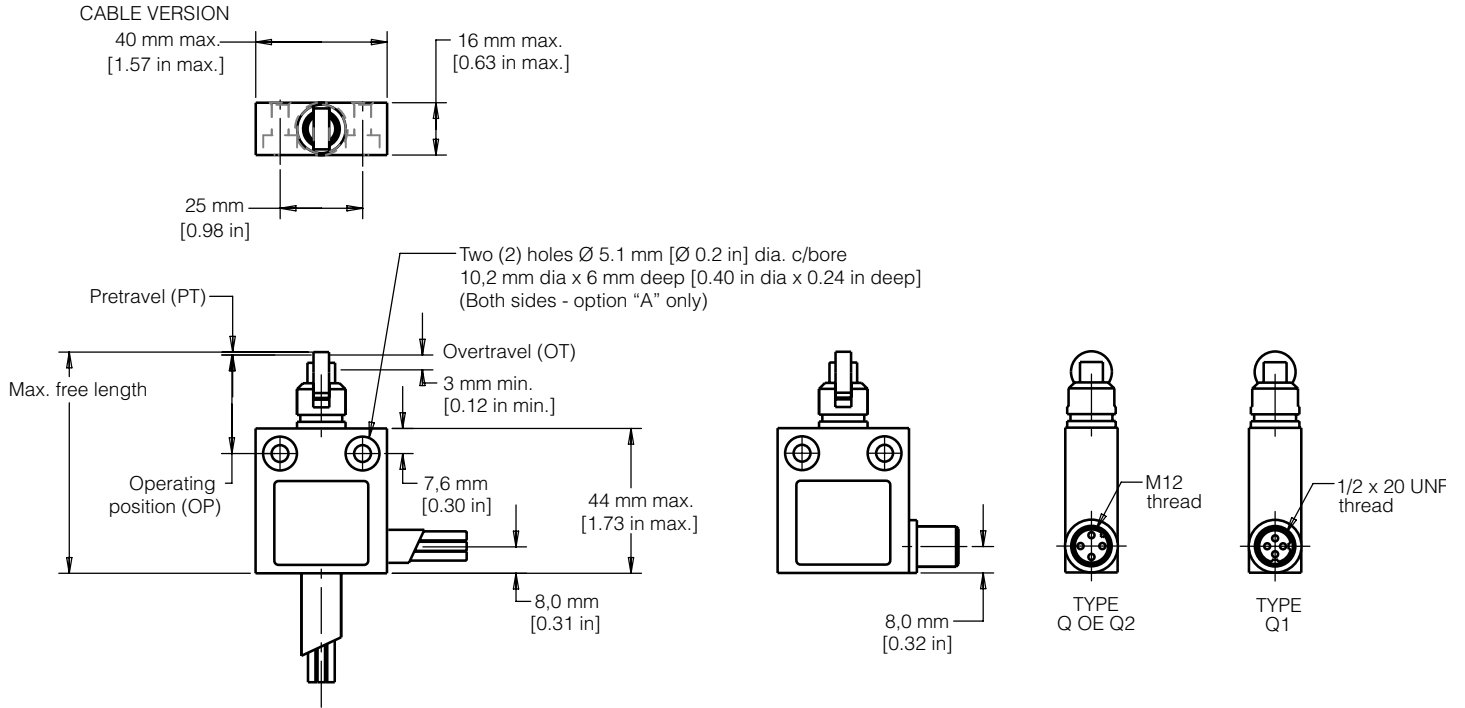

PRODUCT NOMENCLATURE

914CE	29	—	3		
Switch Type	Actuator Type		Cable Length	Options ¹	Connectors
914CE Series Small Precision Limit Switch	1 Top pin plunger	22 Manually oper. nylon button	3 3 feet	A Side entry	Q dc type single keyway
	2 Top roller plunger, parallel	27 Top pin plunger panel mount	6 6 feet	G Gold contacts	Q1 ac type two keyways
	3 Top roller plunger, perp.	28 Top roller plunger, parallel panel mount	9 9 feet	P Top mounting	Q2 dc type optional pin-out
	16 Front rotary	29 Top roller plunger, perp. panel mount	12 12 feet	L1 Low temp. -40 °C, cable not for flexing	
	18 Top pin plunger w/ boot seal	31 Top roller plunger, parallel boot seal	15 15 feet	V Vitron seals/gasket (front rotary only)	
	19 Top adjustable pin plunger	55 Top roller plunger, perp. boot seal			
	20 Coil wobble	66 Top ball bearing plunger			
				Bottom exit is standard.	

NOTE: not all combinations of model code are available.
 Please contact your Honeywell provider/representative for assistance.

¹More than one option may be permissible.

914CE Series

PRODUCT SPECIFICATIONS AND LISTINGS

Contact your Honeywell rep or distributor for additional listings

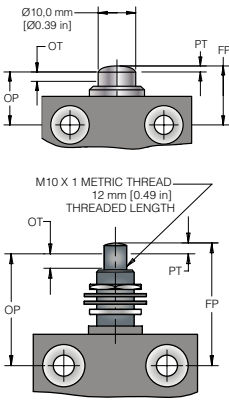
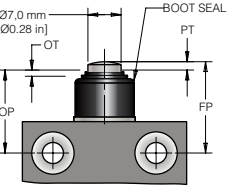
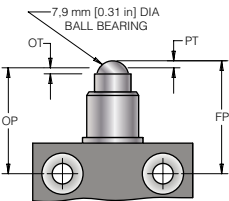
914CE1 • Pin Plunger 914CE27 • Pin Plunger Panel Mount		Contacts	Elec Rating	Cable Exit	Free Position (FP)	Operating Position (OP)	Options	Listing
 <p>Pretravel • 1,8 mm [0.071 in] Diff. travel • 0,1 mm [0.004 in] Overtravel • 3,0 mm [0.118 in] Oper. force • 12,2 N [2.75 in-lb]</p>	Silver	A	Bottom	17,5 mm [0.69 in]	15,7 mm [0.62 in]	–	914CE1-3	
	Gold	B	Bottom	17,5 mm [0.69 in]	15,7 mm [0.62 in]	–	914CE1-3G	
	Silver	A	Side	17,5 mm [0.69 in]	15,7 mm [0.62 in]	–	914CE1-3A	
	Silver	A	Bottom	31,1 mm [1.23 in]	29,3 mm [1.15 in]	Panel mount	914CE27-3	
	Silver	C	Bottom	17,5 mm [0.69 in]	15,7 mm [0.62 in]	dc-type, single keyway	914CE1-Q	
	Silver	C	Bottom	17,5 mm [0.69 in]	15,7 mm [0.62 in]	ac-type, two keyways	914CE1-Q1	
914CE18 • Boot Sealed Pin Plunger		Contacts	Elec Rating	Cable Exit	Free Position (FP)	Operating Position (OP)	Options	Listing
 <p>Pretravel • 1,8 mm [0.071 in] Diff. travel • 0,1 mm [0.004 in] Overtravel • 3,0 mm [0.118 in] Oper. force • 22,2 N [5 in-lb]</p>	Silver	A	Bottom	26,7 mm [1.05]	24,9 mm [0.98 in]		914CE18-3	
	Silver	A	Side	26,7 mm [1.05]	24,9 mm [0.98 in]		914CE18-3A	
	Silver	A	Bottom	26,7 mm [1.05]	24,9 mm [0.98 in]	Fluorocarbon seals	914CE18-3V	
	Silver	C	Bottom	26,7 mm [1.05]	24,9 mm [0.98 in]	ac-type, two keyways	914CE18-Q1	
	Silver	C	Side	26,7 mm [1.05]	24,9 mm [0.98 in]	ac-type, two keyways	914CE18-AQ1	
914CE66 • Ball Bearing Plunger		Contacts	Elec Rating	Cable Exit	Free Position (FP)	Operating Position (OP)	Options	Listing
 <p>Pretravel • 1,8 mm [0.071 in] Diff. travel • 0,1 mm [0.004 in] Overtravel • 3,0 mm [0.118 in] Oper. force • 12,2 N [2.75 in-lb]</p>	Silver	A	Bottom	26,2 mm [1.03 in]	24,4 mm [0.96 in]		914CE66-3	

MICRO SWITCH™ Compact Precision Limit Switches

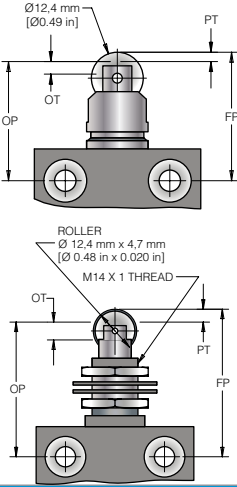
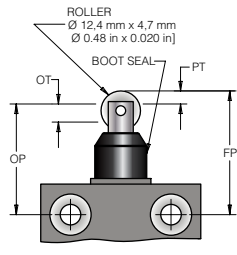
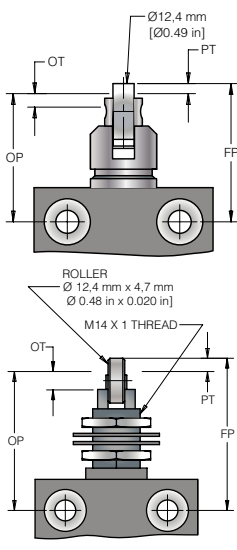
914CE2 • Roller Plunger 914CE28 • Roller Plunger Panel Mount		Contacts	Elec Rating	Cable Exit	Free Position (FP)	Operating Position (OP)	Options	Listing
 <p> Pretravel • 1,8 mm [0.071 in] Diff. travel • 0,1 mm [0.004 in] Overtravel • 3,0 mm [0.118 in] Oper. force • 12,2 N [2.75 in-lb] </p>	Silver	A	Bottom	30,3 mm [1.19 in]	28,5 mm [1.12 in]			914CE2-3
	Gold	B	Bottom	30,3 mm [1.19 in]	28,5 mm [1.12 in]			914CE2-3G
	Silver	C	Bottom	30,3 mm [1.19 in]	28,5 mm [1.12 in]	ac-type, two keyways		914CE2-Q1
	Silver	C	Bottom	30,3 mm [1.19 in]	28,5 mm [1.12 in]	dc-type, single keyway		914CE2-Q
	Silver	A	Side	30,3 mm [1.19 in]	28,5 mm [1.12 in]			914CE2-3A
	Silver	A	Bottom	44,3 mm [1.75 in]	42,5 mm [1.67 in]	Panel mount		914CE28-3
	Silver	C	Bottom	44,3 mm [1.75 in]	42,5 mm [1.67 in]	Panel mount, ac-type, two keyways		914CE28-Q1
914CE31 • Boot Sealed Roller Plunger		Contacts	Elec Rating	Cable Exit	Free Position (FP)	Operating Position (OP)	Options	Listing
 <p> Pretravel • 1,8 mm [0.071 in] Diff. travel • 0,1 mm [0.004 in] Overtravel • 3,0 mm [0.118 in] Oper. force • 22,2 N [5 in-lb] </p>	Silver	A	Bottom	36,2 mm [1.43 in]	34,4 mm [1.36 in]			914CE31-3
	Silver	A	Bottom	36,2 mm [1.43 in]	34,4 mm [1.36 in]	Fluorocarbon seals		914CE31-3V
914CE3 • Cross Roller Plunger 914CE29 • Cross Roller Panel Mount		Contacts	Elec Rating	Cable Exit	Free Position (FP)	Operating Position (OP)	Options	Listing
 <p> Pretravel • 1,8 mm [0.071 in] Diff. travel • 0,1 mm [0.004 in] Overtravel • 3,0 mm [0.118 in] Oper. force • 12,2 N [2.75 in-lb] </p>	Silver	A	Bottom	30,3 mm [1.19 in]	28,5 mm [1.12 in]			914CE3-3
	Gold	B	Bottom	30,3 mm [1.19 in]	28,5 mm [1.12 in]			914CE3-3G
	Silver	A	Side	30,3 mm [1.19 in]	28,5 mm [1.12 in]			914CE3-3A
	Silver	A	Bottom	44,3 mm [1.75 in]	42,5 mm [1.67 in]	Panel mount		914CE29-3
	Silver	C	Bottom	30,3 mm [1.19 in]	28,5 mm [1.12 in]	dc-type, single keyway		914CE3-Q
	Silver	C	Bottom	30,3 mm [1.19 in]	28,5 mm [1.12 in]	ac-type, two keyways		914CE3-Q1

Note: part numbers are shown with 3 ft of cable. The -X indicates the number of feet of cable provided. 6-foot, 9-foot lengths, and 12-foot lengths along with custom lengths, are also available.

914CE Series

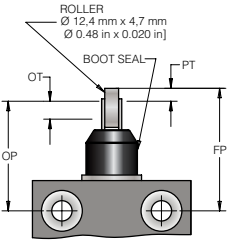
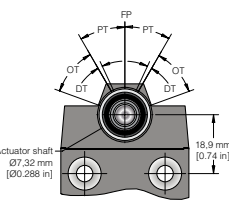
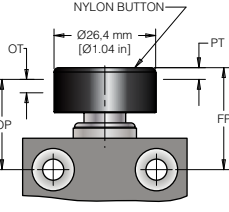
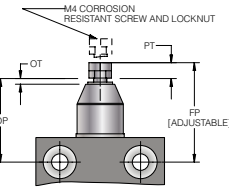
914CE55 • Boot Sealed Cross Roller Plunger		Contacts	Elec Rating	Cable Exit	Free Position (FP)	Operating Position (OP)	Options	Listing
 <p>ROLLER Ø 12,4 mm x 4,7 mm Ø 0.48 in x 0.020 in</p> <p>BOOT SEAL</p> <p>PT</p> <p>OT</p> <p>OP</p> <p>FP</p> <p>Pretravel • 1,8 mm [0.071 in] Diff. travel • 0,1 mm [0.004 in] Overtravel • 3,0 mm [0.118 in] Oper. force • 22,2 N [5 in-lb]</p>	Silver	A	Bottom	36,2 mm [1.43 in]	34,4 mm [1.36 in]			914CE55-3
914CE16 • Side Rotary		Contacts	Elec Rating	Cable Exit	Free Position (FP)	Operating Position (OP)	Options	Listing
 <p>Actuator shaft Ø7,32 mm [0.288 in]</p> <p>18,9 mm [0.74 in]</p> <p>PT</p> <p>OT</p> <p>DT</p> <p>FP</p> <p>Pretravel • 30° Diff. travel • 3° Overtravel • 40° Oper. force • 0,34 Nm [3 in-lb]</p>	Silver	A	Bottom	–	–			914CE16-3¹
	Silver	A	Side	–	–			914CE16-3A¹
	Silver	C	Bottom	–	–	ac-type, two keyways		914CE16-Q1¹
	Silver	C	Bottom	–	–	dc-type, single keyway		914CE16-Q1¹
	Silver	C	Side	–	–	ac-type, two keyways		914CE16-AQ1¹
914CE22 • Manually Operated		Contacts	Elec Rating	Cable Exit	Free Position (FP)	Operating Position (OP)	Options	Listing
 <p>NYLON BUTTON</p> <p>Ø26,4 mm [Ø1.04 in]</p> <p>PT</p> <p>OT</p> <p>OP</p> <p>FP</p> <p>Pretravel • 1,8 mm [0.071 in] Diff. travel • 0,1 mm [0.004 in] Overtravel • 3,0 mm [0.118 in] Oper. force • 8,9 N [2 in-lb]</p>	Silver	A	Bottom	29,2 mm [1.15 in]	27,4 mm [1.08]	23,9 mm [0.94 in] dia. button		914CE22-3
914CE19 • Adjustable Plunger		Contacts	Elec Rating	Cable Exit	Free Position (FP)	Operating Position (OP)	Options	Listing
 <p>M4 CORROSION RESISTANT SCREW AND LOCKNUT</p> <p>PT</p> <p>OT</p> <p>OP</p> <p>FP [ADJUSTABLE]</p> <p>Pretravel • 1,8 mm [0.071 in] Diff. travel • 0,1 mm [0.004 in] Overtravel • 3,0 mm [0.118 in] Oper. force • 17,5 N [5 lb]</p>	Silver	A	Bottom	Adjust.	Adjust.			914CE19-3
	Gold	B	Bottom	33,8 mm	32 mm to 39 mm			914CE19-3G
	Silver	A	Side	to 40,8 mm	[1.26 in to 1.54 in]			914CE19-3A
	Silver	C	Bottom	[1.33 in to 1.61 in]		ac-type, two keyways		914CE19-Q1

¹ Switch operates on clockwise and counterclockwise rotation of lever shaft

MICRO SWITCH™ Compact Precision Limit Switches

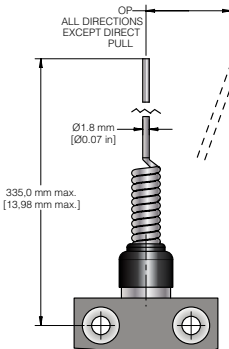
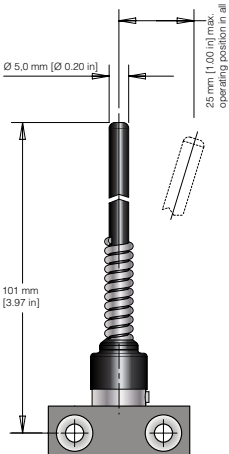
914CE20 • Random Motion Wire Actuator	Contacts	Elec Rating	Cable Exit	Free Position (FP)	Operating Position (OP)	Options	Listing
 <p>OP— ALL DIRECTIONS EXCEPT DIRECT PULL</p> <p>Ø1.8 mm [Ø0.07 in]</p> <p>335.0 mm max. [13.98 mm max.]</p> <p>Oper. point • 28 mm [1.10 in] max. Oper. force • 0,55 N [0.12 lb] max.</p>	Silver	A	Bottom	—	—		914CE20-3
	Silver	A	Side	—	—		914CE20-3A
	Silver	C	Bottom			dc-type, single keyway	914CE20-Q
914CE20-9N24 • Random Motion Plastic Actuator	Contacts	Elec Rating	Cable Exit	Free Position (FP)	Operating Position (OP)	Options	Listing
 <p>Ø5.0 mm [Ø 0.20 in]</p> <p>25 mm [1.00 in] max. in all directions except pull</p> <p>101 mm [3.97 in]</p> <p>Oper. point • 25 mm [0.93 in] max. in all directions except pull Oper. force • 0,55 N [0.12 lb] max.</p>	Silver	A	Bottom	—	—	available with 9-feet of cable only	914CE20-9N24

Note: part numbers are shown with 3 ft of cable. The -X indicates the number of feet of cable provided. 6-foot, 9-foot lengths, and 12-foot lengths along with custom lengths, are also available.

914CE Series

This Honeywell datasheet supports the following MICRO SWITCH™ 914CE Series Limit Switch Listings

914CE1-12	914CE18-GQ	914CE2-3KV	914CE2-N83	914CE55-3A
914CE1-12A	914CE18-Q	914CE2-3L1	914CE2-N85	914CE55-3AG
914CE1-15	914CE18-Q1	914CE2-6	914CE2-N86	914CE66-12
914CE1-15A	914CE1-9	914CE2-6A	914CE2-N87	914CE66-3
914CE1-3	914CE19-12	914CE2-6AK	914CE2-N88	914CE66-6
914CE1-3A	914CE19-3	914CE2-6-C	914CE2-N89	914CE66-9
914CE1-3AK	914CE19-6	914CE2-6G	914CE2-N92	
914CE1-3AKV	914CE19-9	914CE2-6K	914CE2-N95	
914CE1-3G	914CE19-9A	914CE2-6KV	914CE2-N96	
914CE1-3K	914CE1-9A	914CE27-12	914CE2-Q	
914CE1-6	914CE1-AKQ	914CE27-3	914CE2-Q1	
914CE16-12	914CE1-AKQ1	914CE27-6	914CE2-Q2	
914CE16-18	914CE1-AQ	914CE27-9	914CE31-12	
914CE16-18V	914CE1-AQ1	914CE27-AGQ1	914CE31-12A	
914CE16-27	914CE1-GQ1	914CE27-GQ1	914CE31-12AV	
914CE16-3	914CE1-KQ	914CE27-Q	914CE31-18	
914CE16-3A	914CE1-KQ1	914CE28-12	914CE3-12	
914CE16-3N1	914CE1-N94	914CE28-18	914CE3-12AK	
914CE16-6	914CE1-Q	914CE28-3	914CE3-12K	
914CE16-6A	914CE1-Q1	914CE28-6	914CE31-3	
914CE16-6AN14	914CE1-Q2	914CE28-9	914CE31-3A	
914CE16-9	914CE20-12	914CE28-Q	914CE31-3C	
914CE16-9A	914CE20-12G	914CE28-Q1	914CE31-3L1	
914CE1-6A	914CE20-12GL1	914CE2-9	914CE31-3V	
914CE16-AQ	914CE20-3	914CE29-3	914CE31-6	
914CE16-AQ2	914CE20-6	914CE29-6	914CE31-9AL1	
914CE1-6G	914CE20-9	914CE299	914CE31-9L1	
914CE1-6K	914CE20-9L1	914CE29-9	914CE31-9V	
914CE1-6L1	914CE20-N69	914CE29-9L1	914CE31-AQ	
914CE16-N53	914CE20-N77	914CE2-9A	914CE31-N52	
914CE16-N54	914CE20-Q	914CE2-9AK	914CE31-RH09	
914CE16-N79	914CE20-Q1	914CE2-9AL1	914CE3-3	
914CE16-N82	914CE2-12	914CE2-9C	914CE3-3A	
914CE16-N91	914CE2-12AK	914CE2-9G	914CE3-3AK	
914CE16-Q	914CE2-12GK	914CE2-9K	914CE3-3AL1	
914CE16-Q1	914CE2-12GKL1	914CE2-9KL1	914CE3-3G	
914CE16-Q2	914CE212GL1	914CE2-9L1	914CE3-3K	
914CE16QV	914CE2-12KL1	914CE29Q	914CE3-3KL1	
914CE16-QV	914CE2-15	914CE2-9Q	914CE3-3L1	
914CE16-RH29	914CE2-15A	914CE29-Q	914CE3-6	
914CE16-VCQ1	914CE2-18	914CE2-AGQ	914CE3-6A	
914CE18-12	914CE2-21	914CE2-AKLQ	914CE3-6AK	
914CE18-12AL1	914CE22-12	914CE2-AKQV	914CE3-6G	
914CE18-15	914CE2-21N36	914CE2-AQ	914CE3-6K	
914CE18-15A	914CE22-3	914CE2-AQ1	914CE3-9	
914CE18-21A	914CE2-24K	914CE2-KQ	914CE3-9AK	
914CE1827	914CE22-6	914CE2-KQ1	914CE3-9G	
914CE18-27	914CE2-27	914CE2-KQV	914CE3-9K	
914CE18-3	914CE22-9	914CE2-N47	914CE3-9L1	
914CE18-3A	914CE2-3	914CE2-N49	914CE3-9V	
914CE18-3AL1	914CE2-33	914CE2-N50	914CE3-AKQ	
914CE18-6	914CE2-33AK	914CE2-N51	914CE3-AQ	
914CE18-6A	914CE2-33K	914CE2-N55	914CE3-KQ	
914CE18-9	914CE2-33N37	914CE2-N57	914CE3-KQ1	
914CE18-9A	914CE2-3A	914CE2-N58	914CE3-N93	
914CE18-9AGL1	914CE2-3AK	914CE2-N59	914CE3-Q	
914CE18-9AL1	914CE2-3AL1	914CE2N67	914CE3-Q1	
914CE18-9V	914CE2-3G	914CE2-N67	914CE55-12	
914CE18-AQ	914CE2-3K	914CE2-N71	914CE55-3	
914CE18-AQ1	914CE2-3KL1	914CE2-N81	914CE553A	

MICRO SWITCH™ Compact Precision Limit Switches

ADDITIONAL INFORMATION

The following associated literature is available on the Web at sensing.honeywell.com:

- Product installation instructions
- Product range guide
- Product nomenclature tree
- Product application-specific information
 - Limit and enclosed switches application information
 - Limit and enclosed switches operating characteristics
 - Limit and enclosed switches reference standards
 - Limit and enclosed switches typical applications
 - Product flyer: CE Family Miniature Limit Switches

WARNING

PERSONAL INJURY

DO NOT USE these products as safety or emergency stop devices or in any other application where failure of the product could result in personal injury.

Failure to comply with these instructions could result in death or serious injury.

WARNING

MISUSE OF DOCUMENTATION

- The information presented in this product sheet is for reference only. Do not use this document as a product installation guide.
- Complete installation, operation, and maintenance information is provided in the instructions supplied with each product.

Failure to comply with these instructions could result in death or serious injury.

WARRANTY/REMEDY

Honeywell warrants goods of its manufacture as being free of defective materials and faulty workmanship. Honeywell's standard product warranty applies unless agreed to otherwise by Honeywell in writing; please refer to your order acknowledgement or consult your local sales office for specific warranty details. If warranted goods are returned to Honeywell during the period of coverage, Honeywell will repair or replace, at its option, without charge those items it finds defective. **The foregoing is buyer's sole remedy and is in lieu of all other warranties, expressed or implied, including those of merchantability and fitness for a particular purpose. In no event shall Honeywell be liable for consequential, special, or indirect damages.**

While we provide application assistance personally, through our literature and the Honeywell website, it is up to the customer to determine the suitability of the product in the application.

Specifications may change without notice. The information we supply is believed to be accurate and reliable as of this printing. However, we assume no responsibility for its use.

Find out more

Honeywell serves its customers through a worldwide network of sales offices, representatives and distributors. For application assistance, current specifications, pricing or name of the nearest Authorized Distributor, contact your local sales office.

To learn more about Honeywell's sensing and control products, call **+1-815-235-6847** or **1-800-537-6945**, visit **sensing.honeywell.com**, or e-mail inquiries to **info.sc@honeywell.com**

Sensing and Control
Honeywell
1985 Douglas Drive North
Golden Valley, MN 55422
honeywell.com

The Honeywell logo is displayed in a bold, red, sans-serif font.