

Rating	16A 125V AC 10A 250V AC		Mount Hole	Circuit Structure
Contact R	50m ohm Max.			
Insulation R	DC 500V 100M ohm Min.			
Dielectric Strength	AC 1500V 1 minute			
Operation Tempature	-25°C~85°C			
Circuit Options	2P SPST ON-OFF			

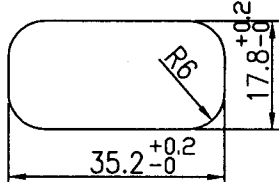
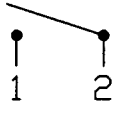
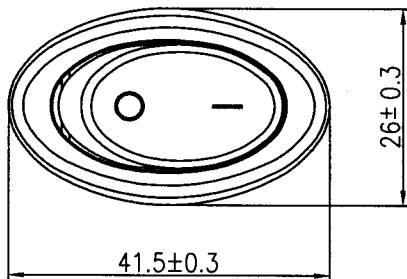

Descriptions:

Frame: Black, Nylon-66 (UL flame: 94V-2)

Actuator: Black, pc

Terminals: Silver plated copper

Printed: White, 0 -

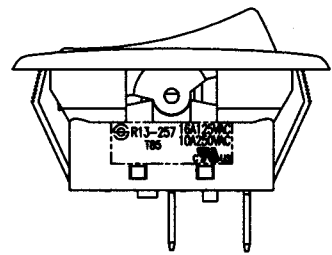
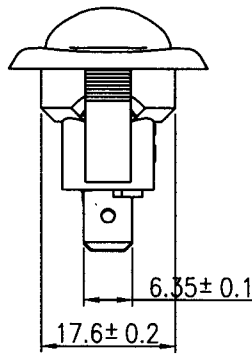
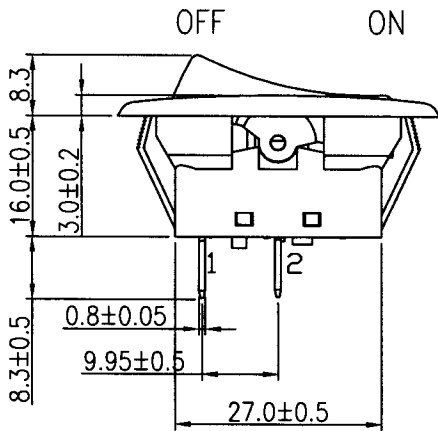

C8\R13\R13-257\R13-257A-01

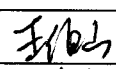
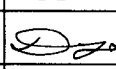
									△
									△
Date	Name	Descriptions							NO
Drawing	Check	Approval	SCI No.	1822865	Model Name	ROCKER SWITCH			
曹盈芳			Customer No.		Model No.	R13-257A-01			
03/09/'04	3/9/04	3/25-04	Unit	mm					