



## INSTALLATION AND OPERATION MANUAL

Software Version 1.0x

Code 81505 / Edition 01 - 03/2013 ENG

### GENERAL INDEX

	page		
	2	<b>4</b>	<b>Standard configuration menu</b> 9
<b>1</b>	<b>Preliminary instructions</b> 2	<b>5</b>	<b>Configuration and programming</b> 10
	General description 2	<b>6</b>	<b>Alarms</b> 12
	Electrical interface 2	<b>7</b>	<b>Control actions</b> 12
	Preliminary warnings 3	<b>8</b>	<b>Manual Tuning</b> 13
<b>2</b>	<b>Installation and connection</b> 4	<b>9</b>	<b>Software ON/OFF switching function</b> 13
	Electrical power supply 4	<b>10</b>	<b>Auto-tuning</b> 13
	Notes concerning electrical safety and Electromagnetic compatibility 4	<b>11</b>	<b>Self-tuning</b> 14
	Advice for correct installation for EMC 5	<b>12</b>	<b>Controls</b> 14
	Instrument power supply 5	<b>13</b>	<b>Technical specifications</b> 15
	Inputs and outputs connection 5	<b>14</b>	<b>Accessories</b> 16
	Dimensions and cut-out 6		
	Installation with panel mounting 6		
	Warnings and instructions for mounting to the panel 6		
	Nominal ambient conditions 6		
	Electrical connections 7		
<b>3</b>	<b>Functions</b> 8		

 *The contents of each section are summarized immediately following the section heading*

## Graphic symbols used

To distinguish between the type and importance of the information provided in these instructions for use, graphic symbols have been used as a reference to make interpreting the information clearer.

 Indicates the contents of the various manual sections, the general warnings, notes, and other points to which the reader's attention should be drawn.

 Indicates a particularly delicate situation that could affect the safety and correct working operation of the controller, or a rule that must be strictly observed to avoid dangerous situations

 Indicates a condition of risk for the safety of the user, due to the presence of dangerous voltages at the points shown

 Indicates a suggestion based on the experience of the GEFTRAN Technical Staff, which could prove especially useful under given circumstances

 Indicates a reference to Detailed Technical Documents available on the GEFTRAN web site [www.gefran.com](http://www.gefran.com)

## 1 • PRELIMINARY INSTRUCTIONS

 *This section contains information and warnings of a general nature which should be read before proceeding with controller installation, configuration and use.*

### General Description

The series 450 temperature controller, measuring 48x48mm (1/16 DIN), offers simplicity of use and high quality of control.

The input from temperature sensors is "universal" and configurable with type J, K, R, S, T, B, E, N thermocouples and with 3-wire Rt100 resistance thermometers.

The user interface has a complete double display with green LEDs, 4 keys, and two red LEDs to signal active outputs.

The Lexan® membrane on the front panel guarantees an IP65 protection level for these products.

The controller outputs, freely configurable as control output and alarm output, are available in a 5A/250VAC relay version or in a logic signal version to drive solid state relays.

The input signal read speed (120msec) and the tested PID control algorithm with selftuning and autotuning parameter functions guarantee accurate and stable control even for rapid and discontinuous heating systems.

Series 450 models are factory-configured to satisfy most industrial heating applications (input for probe J, hot PID setting, 10 second cycle time) and can always be modified from keyboard and from PC with a few parameters grouped on intuitive menus.

A programming kit for PC is available, consisting of a cable and a user-friendly program for Windows with Wizard pages, oscilloscope for process analysis, saving of parameter recipes, and ability to reset factory parameters. A settable software protection code (password-protected) lets you limit access to internal parameters to various levels, up to total protection.

### Electrical Interface

All connection terminals (power supply, inputs, outputs, options) are grouped together on the back of the instrument.

For technical specifications and performance details refer to Section 13 "Technical Specifications".

## Preliminary Warnings



*The following preliminary warnings should be read before installing and using the series 450 controller. This will allow the controller to be put into service more quickly and will avoid certain problems which may mistakenly be interpreted as malfunctions or limitations of the controller.*

- Immediately after unpacking the controller, make a note of the order code and the other identification data given on the label affixed to the outside of the container and copy them to the table below. These details must always be kept close at hand and referred to the personnel involved in the event of help from Gefran Customer Service Assistance.

SN: .....	(Serial n°)
CODE: .....	(Finished product code)
TYPE: .....	(Order Code)
SUPPLY: .....	(Type of electrical power supply)
VERS: .....	(Software version)

- Check also that the instrument is complete and has not been damaged at all during transit, and that the package contains not only the controller and these Instructions for Use, but also the kit for fixing to the panel and the dust protection seal - see: Installation with Panel Fixing in Section 2. Any inconsistencies, omissions or evident signs of damage should be reported immediately to your Gefran sales agent.
- Check that the order code corresponds with the configuration requested for the application the instrument is needed for.
  - N°. and Type of Inputs/Outputs available
  - Presence of the necessary options and accessories
  - Mains voltage supply

**Example: 450 – R – R – 0**  
Model 450  
2 relay outputs  
Power supply 11...27Vac/dc
- Before installing the instrument series 450 on the control panel of the machine or host system, refer to the paragraph “Dimensions and Cut-out” in Section 2 “Installation and Connection”.
- Where configuration by PC is provided for, make sure the interface RS232 cable is available and the CD-ROM containing the GF\_eXpress software. For the order code refer to Section 14 “Accessories”.



Users and/or system integrators who wish to know more about the concepts of serial communication between standard PC and or Gefran Industrial PC and Gefran Programmable Instruments, can access the various technical reference Documents in Adobe Acrobat format available in the Download section of the Gefran Web Site **www.gefran.com** including:

- Serial Communication
- MODBus Protocol

In the same Download section of the Gefran Web Site **www.gefran.com** the instrument serie 450 reference manual is available in Adobe Acrobat format, containing a detailed description of all the adjustable parameters and procedures.

In the event of presumed instrument malfunction, before contacting Gefran Technical Service Assistance, refer to the F.A.Q. Section (Frequently Asked Questions) on the Gefran Web Site **www.gefran.com**

## 2 • INSTALLATION AND CONNECTION



*This section contains the instructions necessary for correct installation of the instrument series 450 into the machine control panel or the host system and for correct connection of the controller power supply, inputs, outputs.*



**Before proceeding with installation read the following warnings carefully!**  
**Remember that lack of observation of these warnings could lead to problems of electrical safety and electromagnetic compatibility, as well as invalidating the warranty.**

### Electrical power supply

- the instrument is NOT equipped with an On/Off switch: the user must provide a two-phase disconnecting switch that conforms to the required safety standards (CE marking), to cut off the power supply upstream of the instrument.  
The switch must be located in the immediate vicinity of the instrument and must be within easy reach of the operator.  
One switch may control more than one controller.
- if the instrument is connected to NOT isolated electrical equipment (e.g. thermocouples), the earth connection must be made with a specific conductor to prevent the connection itself from coming directly through the machine structure.
- if the instrument is used in applications with risk of

damage to persons, machinery or materials, it is essential to connect it up to auxiliary alarm equipment. It is advisable to make sure that alarm signals are also triggered during normal operation. The instrument must NOT be installed in flammable or explosive environments; it may be connected to equipment operating in such atmospheres only by means of appropriate and adequate types of interface, conforming to the applicable safety standards.

### Notes Concerning Electrical Safety and Electromagnetic Compatibility:

#### CE MARKING:

The instrument conforms to the European Directives 2004/108/CE and 2006/95/CE with reference to the generic standards: **EN 61000-6-2** (immunity in industrial environment) **EN 61000-6-3** (emission in residential environment) **EN 61010-1** (safety).

The instrument series 450 are mainly designed to operate in industrial environments, installed on the switchboards or control panels of productive €process machines or plants.

As regards electromagnetic compatibility, the strictest generic standards have been adopted, as indicated in the table below.

### EMC conformity has been tested with the following connections.

Function	Cable type	Length
Power supply cable	1mm <sup>2</sup>	1m
Relay output cables	1mm <sup>2</sup>	3,5m
Thermocouple input	0,8mm <sup>2</sup> compensated	5m
“PT100” temperature resistance	1mm <sup>2</sup>	3m
Digital Inputs / Outputs	1mm <sup>2</sup>	3,5m

EMC Emission		
Generic standards, emission standard for residential commercial and light industrial environments	EN 61000-6-3	
Emission enclosure	EN 61000-6-3	
Emission AC mains	EN 61000-6-3	Group1 Class B
Radiated emission	EN 61326 CISPR 16-2	Class B
EMC Immunity		
Generic standards, immunity standard for industrial environments	EN 61000-6-2	
Immunity ESD	EN 61000-4-2	4 kV contact discharge level 2 8 kV air discharge level 3
Immunity RF interference	EN 61000-4-3 /A1	10 V/m amplitude modulated 80 MHz-1 GHz 10 V/m amplitude modulated 1.4 GHz-2 GHz
Immunity conducted disturbance	EN 61000-4-6	10 V/m amplitude modulated 0.15 MHz-80 MHz (level 3)
Immunity burst	EN 61000-4-4	2 kV power line (level 3) 2 kV I/O signal line (level 4)
Immunity pulse	EN 61000-4-5	Power line-line 1 kV (level 2) Power line-earth 2 kV (level 3) Signal line-earth 1 kV (level 2)
Immunity Magnetic fields	EN 61000-4-8	100 A/m (level 5)
Voltage dips, short interruptions and voltage immunity tests	EN 61000-4-11	100%U, 70%U, 40%U,
LVD Safety		
Safety requirements for electrical equipment for measurement, control and laboratory use	EN 61010-1	



### Advice for Correct Installation for EMC

#### Instrument power supply

- The power supply to the electronic equipment on the switchboards must always come directly from an isolation device with a fuse for the instrument part.
- The electronic instruments and electromechanical power devices such as relays, contactors, solenoid valves, etc., must always be powered by separate lines.
- When the electronic instrument power supply is strongly disturbed by the commutation of transistor or power units or motors, an isolation transformer should be used for the controllers only, earthing the screen.
- It is essential that the plant has a good earth connection:
  - the voltage between neutral and earth must not be >1V
  - the Ohmic resistance must be < 6Ω;
- If the mains voltage fluctuates strongly, use a voltage stabilizer.
- In the proximity of high frequency generators or arc welders, use adequate mains filters.
- The power supply lines must be separate from the instrument input and output ones.

#### Inputs and outputs connection

- The externally connected circuits must be doubly isolated.
- To connect the analogue inputs and analog outputs the following is necessary:
  - physically separate the input cables from those of the power supply, the outputs and the power connections.
  - use woven and screened cables, with the screen earthed in one point only.
- To connect the relay outputs (contactors, solenoid valves, motors, fans, etc.), fit RC groups (resistance and condensers in series) in parallel to the inductive loads that operate in Alternating Current.
 

*(Note: all the condensers must conform to VDE (class X2) standards and withstand a voltage of at least 220V AC. The resistances must be at least 2Ω).*
- Fit a 1N4007 diode in parallel with the coil of the inductive loads that operate in Direct Current.



**GEFRAN S.p.A. declines all responsibility for any damage to persons or property caused by tampering, neglect, improper use or any which does not conform to the characteristics of the controller and to the indications given in these instructions for Use.**

## Dimensions and cut-out

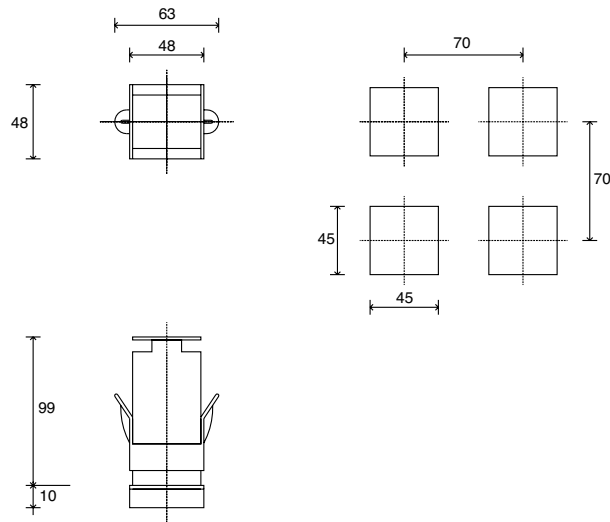

### Installation with panel mounting

As well as the actual instrument and these instructions for use, the controller package also contains:

- panel fixing kit (A)
- 1 protective seal against dust and water spray (B)

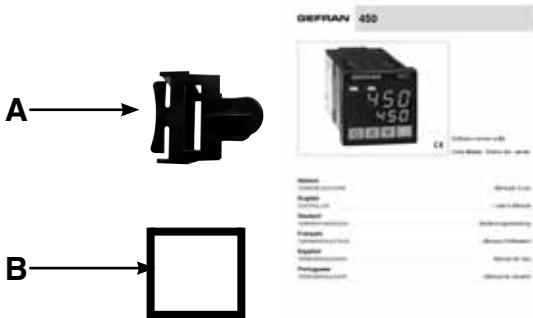

Fit the instrument to the panel as shown in the figure.

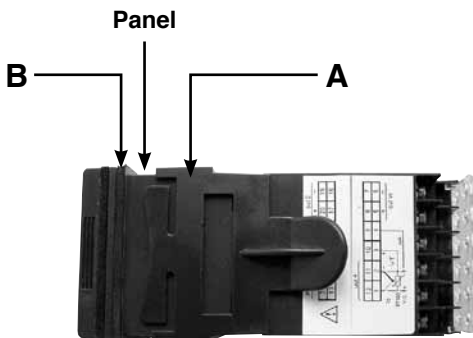

### Warnings and instructions for mounting to the panel

#### Instructions for installation category II, pollution level 2, double isolation.



The equipment is intended for permanent indoor installations within their own enclosure or panel mounted enclosing the rear housing and exposed terminals on the back

- only for models with 11...27Vac/dc power supply: supply from Class 2 or low voltage limited energy source
- the power supply lines must be separate from the controller input and output ones
- group the instruments together keeping them separate from the powered part of the relay
- do not install high-power remote switches, contactors, relays, thyristor power units (especially the "phase angle" type), motors, etc. in the same switchboard
- avoid dust, humidity, corrosive gasses and heat sources
- do not block the ventilation holes: the working temperature must be between 0...50°C
- surrounding air: 50°C
- use 60/75°C copper (Cu) conductor only, wire size range 2x N. 22 - 14AWG, Solid/Stranded
- use terminal tightening torque 0.5Nm

Altitude	Up to 2000m
Working/storage temperature	0..50°C/-20...70°C
Non condensing relative humidity	20...85%

#### Nominal ambient conditions



**Before supplying the Indicator with power, make sure that the mains voltage is the same as that shown in the last number of the order code.**

Example:

450 - x - R - 0 = 11...27Vac/dc

450 - x - R - 1 = 100...240Vac

# Electrical Connections

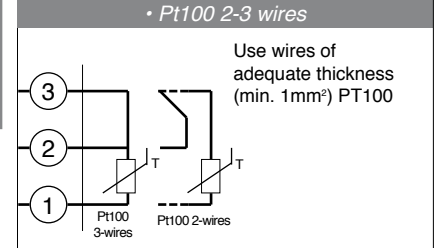
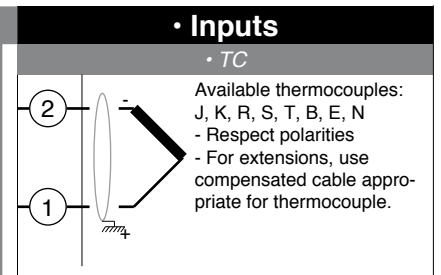
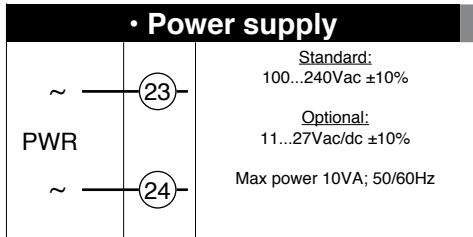
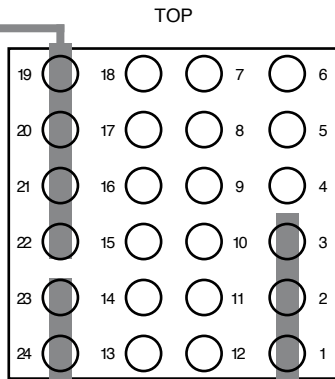
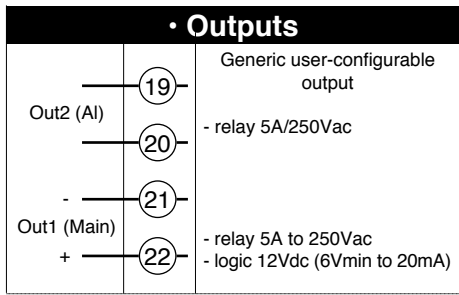

## Device structure: identification of boards

CPU BOARD (Sealing Side)  
S4 = ON Enable Configuration

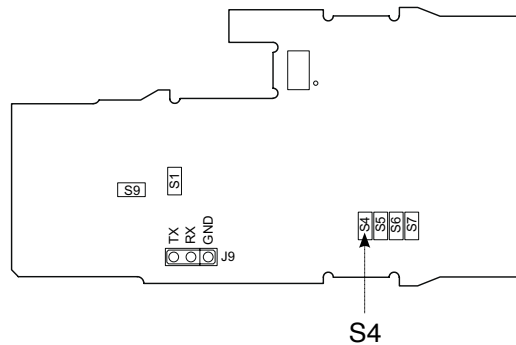

for inverse OUT1: S2 = ON, remove R20  
for inverse OUT2: S1 = ON, remove R5



power HV RR/DR sealing side

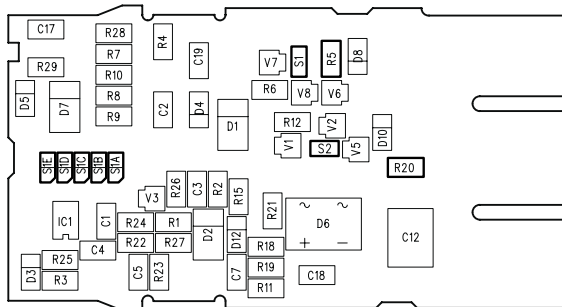

power LV RR/DR sealing side

### 3 • FUNCTIONS



This section describes the use and functions of the displays, lighted indicators and buttons making up the controller operator interface.

It therefore contains essential information for correct programming and configuration of the controllers.

#### Operator interface

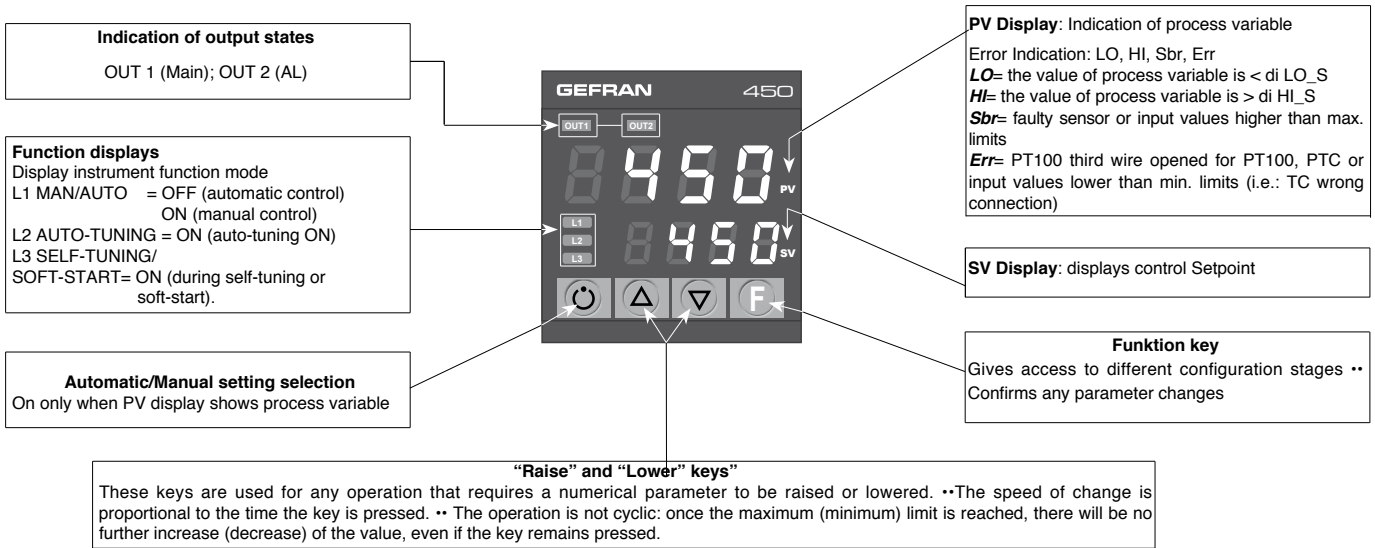



## 4 · STANDARD CONFIGURATION MENU

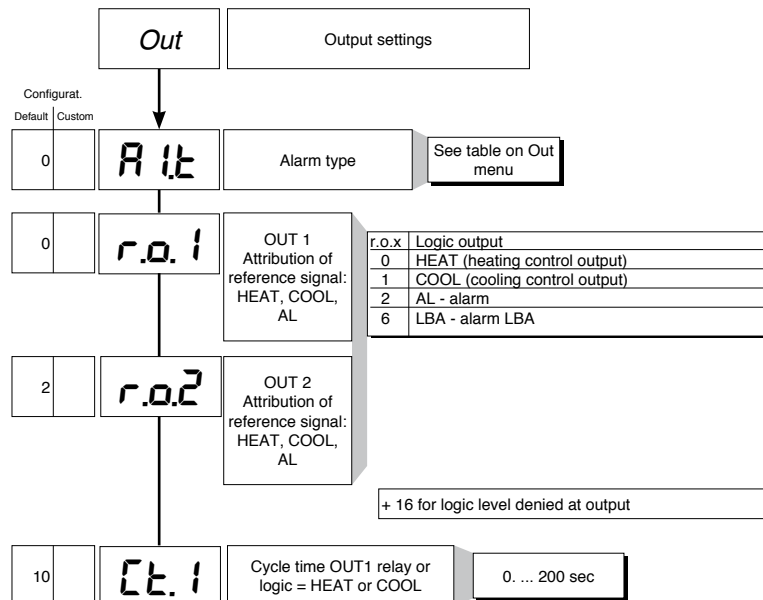
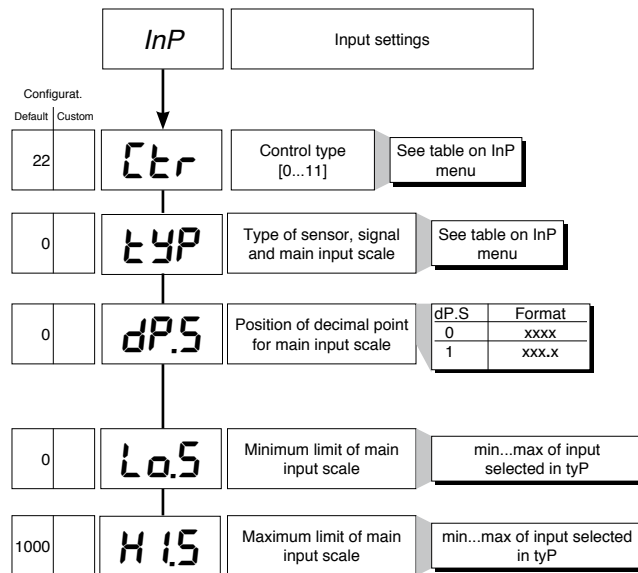
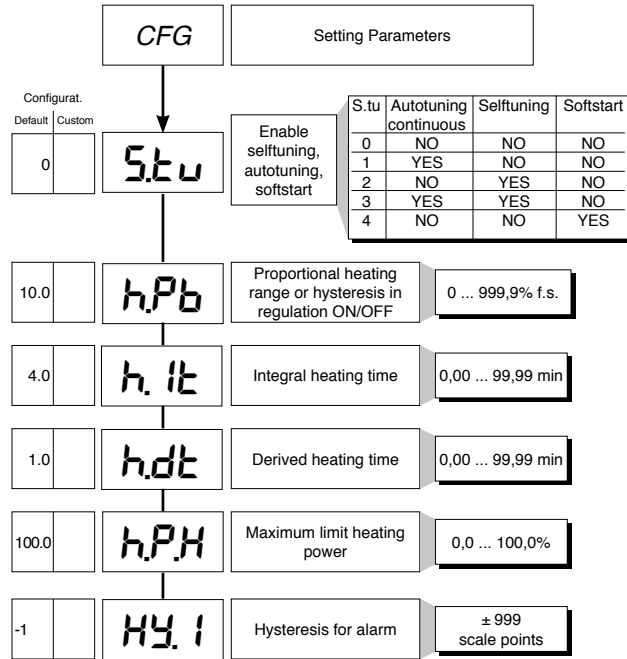

# 5 • PROGRAMMING and CONFIGURATION

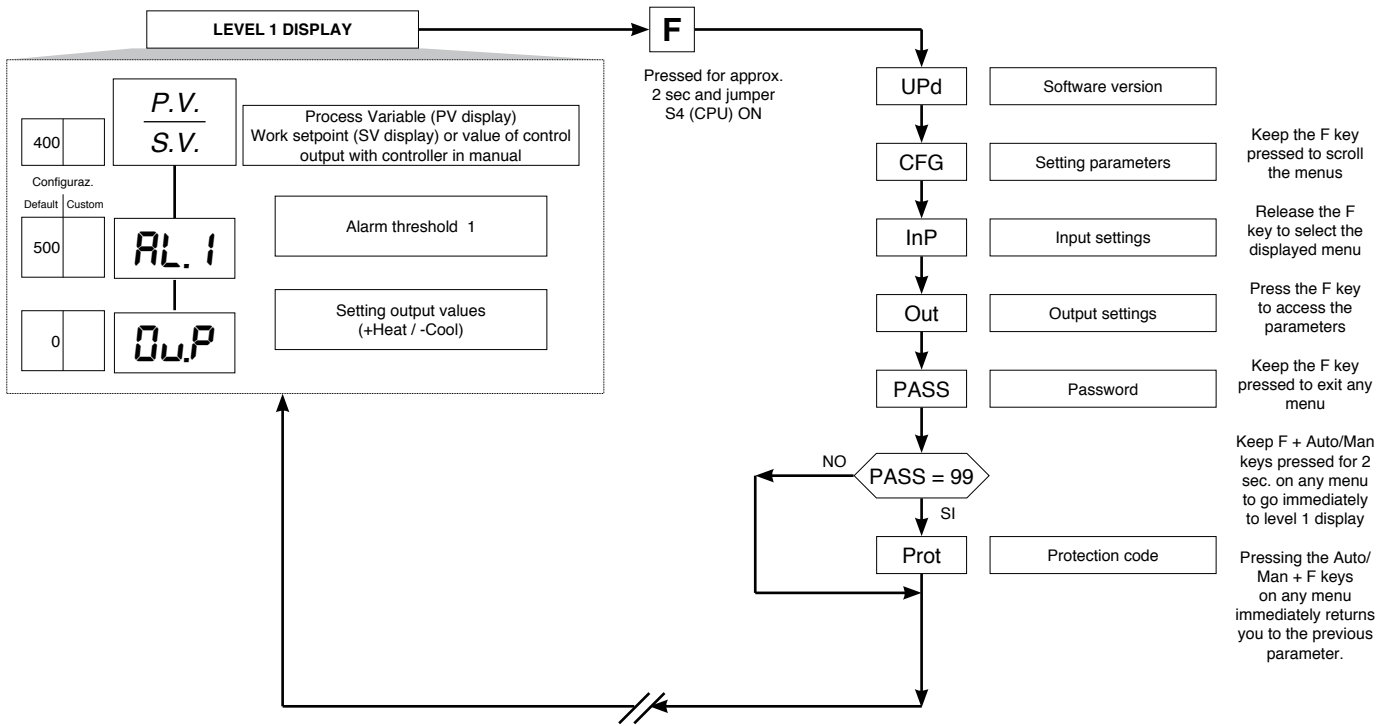

**NB:** Parameters not required for a particular configuration are not displayed

## • CFG

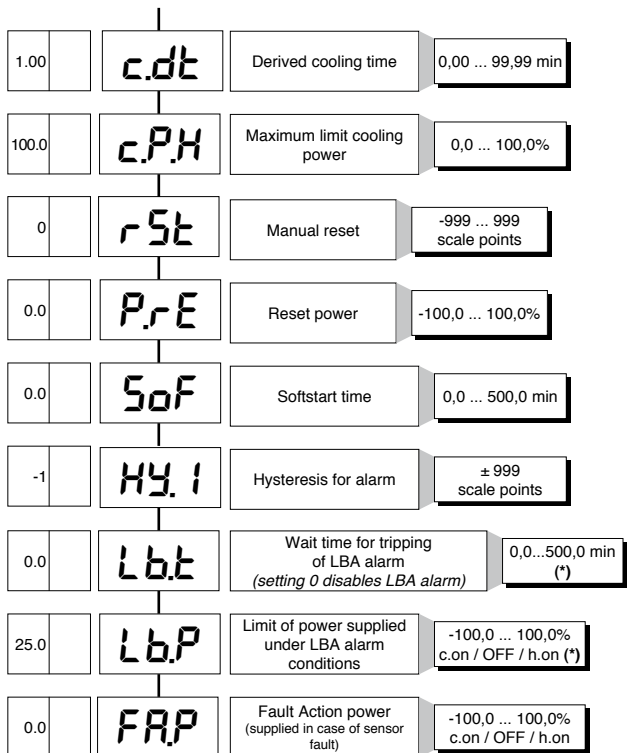
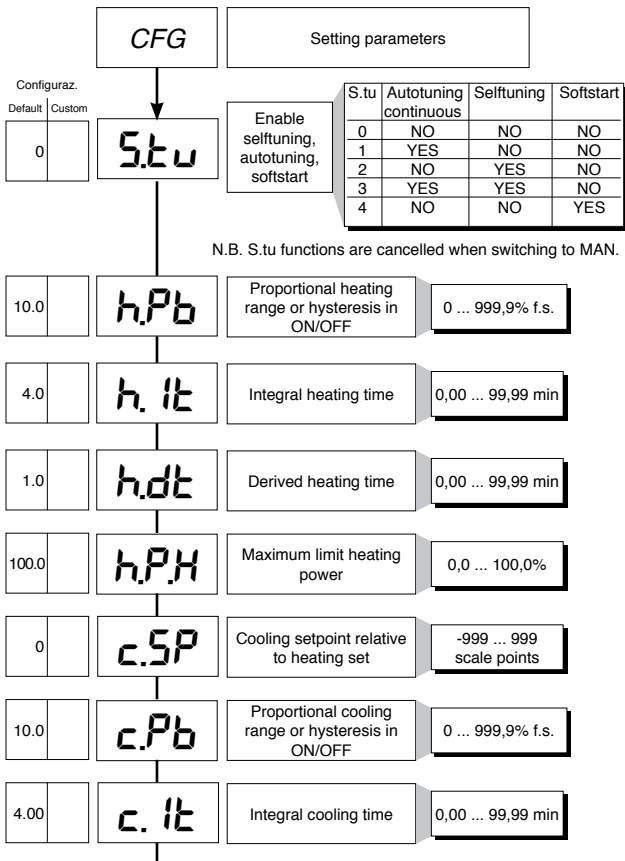

(\*) If the LBA alarm is active (display flashing alternately with 4 decimal points), you can cancel it by pressing keys  $\Delta$  +  $\nabla$  when OutP is seen, or by switching to Manual.

N.B.: the LBA alarm is excluded for ON/OFF controls

Configuraz. Default Custom

InP

Input settings

22 Ctr

Type of control [0...91]

Ctrl	Type of control
0	P hot
1	P cold
3	PI hot
4	PI cold
6	PID hot
7	PID cold
9	ON-OFF hot
10	ON-OFF cold

**+16 disable parameters**  
 CFG: rst, PrE, SoF, Lbt, Lbp, FAP,  
 InP: FLt, FLd, oFS, LoL, HiL  
 Out: ALn, rEL

FLt, FLd, Lbp, HiL stay at set value.  
 ALn is forced to 1  
 All other parameters are considered 0

Default: derived action sample time = 1 sec  
 +32: derived action sample time = 8sec  
 +64: derived action sample time = 240msec with derived action filter assigned to Fit parameter (time filter)

0 TYP

Type of probe, signal and scale of main input

**SENSOR: TC**

tYP	Type of probe	Scale (C/F)	Max. scale range without decimal point	Max. scale range with decimal point
0	J (Fe-CuNi)	C	0 / 1000	0,0 / 999,9
1	J (Fe-CuNi)	F	32 / 1832	32,0 / 999,9
2	K (NiCr-Ni)	C	0 / 1300	0,0 / 999,9
3	K (NiCr-Ni)	F	32 / 2372	32,0 / 999,9
4	R (Pt13Rh - Pt)	C	0 / 1750	0,0 / 999,9
5	R (Pt13Rh - Pt)	F	32 / 3182	32,0 / 999,9
6	S (Pt10Rh - Pt)	C	0 / 1750	0,0 / 999,9
7	S (Pt10Rh - Pt)	F	32 / 3182	32,0 / 999,9
8	T (Cu-CuNi)	C	-200 / 400	-199,9 / 400,0
9	T (Cu-CuNi)	F	-328 / 752	-199,9 / 752,0
10	B (Pt30Rh - Pt6Rh)	C	44 / 1800	44,0 / 999,9
11	B (Pt30Rh - Pt6Rh)	F	111 / 3272	111,0 / 999,9
12	E (NiCr-CuNi)	C	-100 / 750	-100,0 / 750,0
13	E (NiCr-CuNi)	F	-148 / 1382	-148,0 / 999,9
14	N (NiCrSi-NiSi)	C	0 / 1300	0,0 / 999,9
15	N (NiCrSi-NiSi)	F	32 / 2372	32,0 / 999,9

**SENSOR: RTD 3 wires**

tYP	Type of probe	Scale (C/F)	Max. scale range without decimal point	Max. scale range with decimal point
16	PT100	C	-200 / 850	-199,9 / 850,0
17	PT100	F	-328 / 1562	-199,9 / 999,9

Max. non-linearity error for thermocouples (TC), resistors (PT100)

The error is calculated as deviation from theoretical value and is expressed as percentage of full scale (°C)

**S, R** range 0...1750°C; error < 0.2% f.s. (t > 300°C) / for other range; error < 0.5% f.s.  
**T** error < 0.2% f.s. (t > -150°C)  
**B** range 44...1800°C; error < 0.5% f.s. (t > 300°C) / range 44,0...999,9; error < 1% f.s. (t > 300°C)

Tc: **J, K, E, N,** error < 0,2% f.s.  
 error < 0,2% f.s.  
**PT100** scale -200...850°C  
 Precision better than 0,2% f.s. at 25°C.

0.1 FLt

Digital filter on main input

0,0 ... 20,0 sec

0.5 FLd

Digital filter on display of process variable; acts as hysteresis

0 ... 9,9 scale points

0 dPS

Decimal point position for main input scale

dP.S	Format
0	xxxx
1	xxx.x

0 LoS

Minimum limit of main input scale

min...max scale of input selected in tYP

1000 HiS

Maximum limit of main input scale

min...max scale of input selected in tYP

0 oFS

Main input offset correction

-999 ... 999 scale points

0 LoL

Lower limit for local setpoint and absolute alarms

Lo.S ... Hi.S

1000 HiL

Upper limit for local setpoint and absolute alarms

Lo.S ... Hi.S

• Out

Out

Output settings

Configuraz. Default Custom

1 ALn

Number of alarms

0..1

0 ALt

Alarm type

ALt	Direct (maximum) Inverse (minimum)	Absolute Relative to active setpoint	Normal Symmetrical (window)
0	direct	absolute	normal
1	inverse	absolute	normal
2	direct	relativo	normal
3	inverse	relativo	normal
4	direct	absolute	symmetrical
5	inverse	absolute	symmetrical
6	direct	relativo	symmetrical
7	inverse	relativo	symmetrical

+ 8 to disable on power-up until first alarm

0 r.o.1

OUT 1 Attribution of reference signal: HEAT, COOL, AL

r.o.x	Output function
0	HEAT (heating control output)
1	COOL (cooling control output)
2	AL - alarm
6	LBA - allrm LBA

2 r.o.2

OUT 2 Attribution of reference signal: HEAT, COOL, AL

+ 16 for logic level denied at output

10 Ct.1

Cycle time OUT1 relay or logic = HEAT or COOL

1 ... 200 sec

10 Ct.2

Cycle time OUT2 relay or logic = HEAT or COOL

1 ... 200 sec

0 rEL

Fault action (definition of state in case of broken sensor) alarms AL. Select intrinsic safety.

rEL	Alarm
0	OFF
1	ON

- 1) In case of broken sensor, the logic state of the alarm assumes the selected logic value without considering alarm type (direct or inverse): ON = alarm ON, OFF = alarm OFF
- 2) The alarm is assigned to available outputs by setting codes r.o.1, r.o.2.

Configuraz.  
Default | Custom

64

Pro

Protection code

Pro	Display	Change
0	SP, alarm, OutP	SP, alarm
1	SP, alarm, OutP	SP
2	SP	SP
3	SP	

+4 disables InP, Out  
+8 disables CFG  
+16 disables "SW turn on - turn off"  
+32 disables MAN/AUTO key  
+64 to disable manual power memorization

To activate the turn off SW function, press keys F  
F + Δ for 5 secs. in P.V.  
To return to normal functioning, press key F for  
5 secs.

6 •

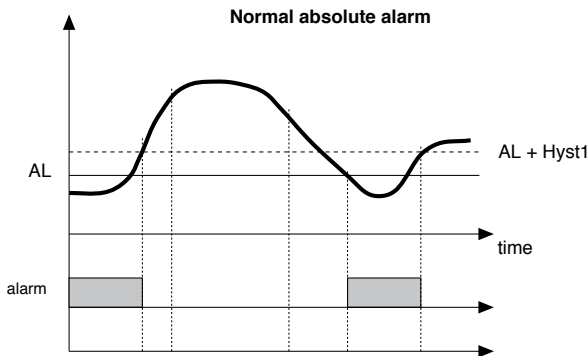

For AL = reverse absolute alarm (low) with positive Hyst1, AL1 t = 1  
(\*) = OFF if disabled on power-up

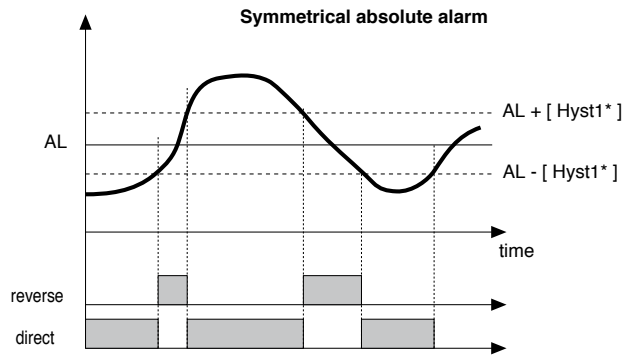

For AL = symmetrical Lo absolute alarm with Hyst1, AL1 t = 5  
For AL = symmetrical Hi absolute alarm with Hyst1, AL1 t = 4

\* Minimum hysteresis = 2 scale points

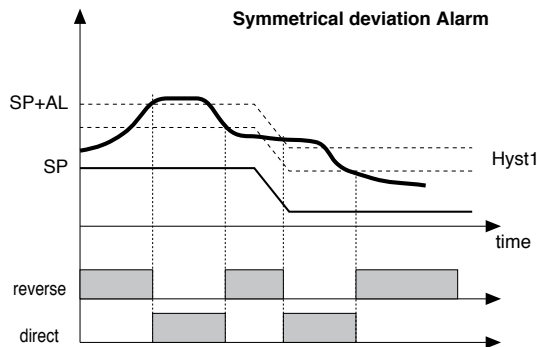

For AL = Lo deviation alarm with negative Hyst 1, AL1 t = 3  
For AL = Hi deviation alarm with negative Hyst 1, AL1 t = 2

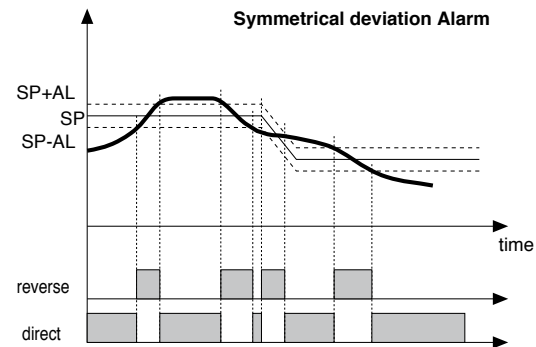

For AL = Symmetrical Lo deviation alarm with Hyst 1, AL1 t = 7  
For AL = Symmetrical Hi deviation alarm with Hyst 1, AL1 t = 6

7 • CONTROL ACTIONS

**Proportional Action:**

action in which contribution to output is proportional to deviation at input (deviation = difference between controlled variable and setpoint).

**Derivative Action:**

action in which contribution to output is proportional to rate of variation input deviation.

**Integral Action:**

action in which contribution to output is proportional to integral of time of input deviation.

**Influence of Proportional, Derivative and Integral actions on response of process under control**

- \* An increase in P.B. reduces oscillations but increases deviation.
- \* A reduction in P.B. reduces the deviation but provokes oscillations of the controlled variable (the system tends to be unstable if P.B. value is too low).
- \* An increase in Derivative Action corresponds to an increase in Derivative Time, reduces deviation and prevents oscillation up to a critical value of Derivative Time, beyond which deviation increases and prolonged oscillations occur.
- \* An increase in Integral Action corresponds to a reduction in Integral Time, and tends to eliminate deviation between the controlled variable and the setpoint when the system is running at rated speed.  
If the Integral Time value is too long (Weak integral action), deviation between the controlled variable and the setpoint may persist.  
Contact GEFRA for more information on control actions.

## 8 · MANUAL TUNING

- A)** Enter the setpoint at its working value.  
**B)** Set the proportional band at 0.1% (with on-off type setting).

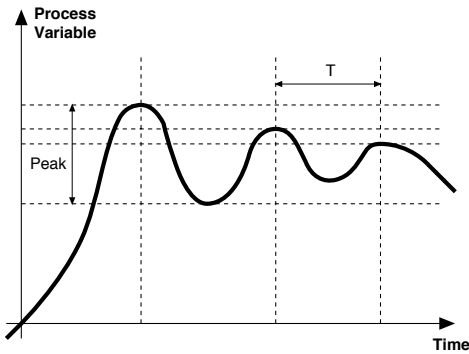

- C)** Switch to automatic and observe the behavior of the variable. It will be similar to that in the figure:  
**D)** The PID parameters are calculated as follows: Proportional band

$$P.B. = \frac{\text{Peak}}{(V \text{ max} - V \text{ min})} \times 100$$

(V max - V min) is the scale range.

Integral time:  $I_t = 1.5 \times T$

Derivative time:  $d_t = I_t/4$

- E)** Switch the unit to manual, set the calculated parameters. Return to PID action by setting the appropriate relay output cycle time, and switch back to Automatic.

- F)** If possible, to optimize parameters, change the setpoint and check temporary response. If an oscillation persists, increase the proportional band. If the response is too slow, reduce it.

## 9 · SOFTWARE ON / OFF SWITCHING FUNCTION

**How to switch the unit OFF:** hold down the “F” and “Raise” keys simultaneously for 5 seconds to deactivate the unit, which will go to the OFF state while keeping the line supply connected and keeping the process value displayed. The SV display is OFF.

All outputs (alarms and controls) are OFF (logic level 0, relays de-energized) and all unit functions are disabled except the switch-on function and digital communication.

**How to switch the unit ON:** hold down the “F” key for 5 seconds and the unit will switch OFF to ON. If there is a power failure during the OFF state, the unit will remain in OFF state at the next power-up (ON/OFF state is memorized).

The function is normally enabled, but can be disabled by setting the parameter Prot = Prot +16.

## 10 · AUTO-TUNING

Enabling the auto-tuning function blocks the PID parameter settings.

Is activated via the Stu parameter (values 1, 3).

It continuously reads system oscillations, immediately seeking the PID parameter values that reduce the current oscillation.

It does not engage if the oscillations drop below 1.0% of the proportional band. It is interrupted if the set-point is changed,

and automatically resumes with a constant set-point.

The calculated parameters are not saved if the instrument is switched off, if the instrument is switched to manual, or if the configuration code is disabled.

The controller resumes with the parameters programmed before auto-tuning was enabled.

## 11 · SELF-TUNING

The function works for single output systems (heating or cooling). The self-tuning action calculates optimum control parameter values during process startup. The variable (for example, temperature) must be that assumed at zero power (room temperature).

The controller supplies maximum power until an intermediate value between starting value and setpoint is reached, after which it zeros power.

PID parameters are calculated by measuring overshoot and the time needed to reach peak. When calculations are finished, the system disables automatically and the control proceeds until the setpoint is reached.

### How to activate self-tuning at power-on:

1. Set the setpoint to the required value
2. Enable selftuning by setting the Stun parameter to 2 (CFG menu)
3. Turn off the instrument
4. Make sure the temperature is near room temperature
5. Turn on the instrument again

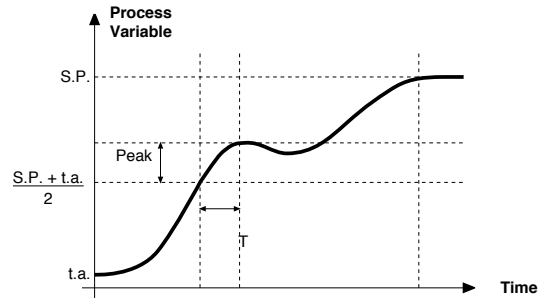

The procedure runs automatically until finished, when the new PID parameters are stored: proportional band, integral and derivative times calculated for the active action (heating or cooling). In case of double action (heating or cooling), parameters for the opposite action are calculated by maintaining the initial ratio between parameters (ex.:  $CPb = HPb * K$ ; where  $K = CPb / HPb$  when self-tuning starts). When finished, the Stun code is automatically cancelled.

### Notes :

The procedure does not start if the temperature is higher than the setpoint (heating control mode) or if the temperature is lower than the setpoint (cooling control mode). In this case, the Stu code is not cancelled.

Action not considered in the type of control ON/OFF

## 12 · CONTROLS

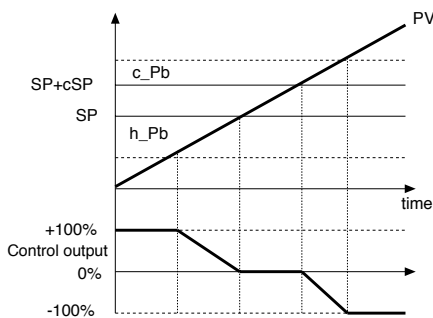

Control output with proportional action only if proportional heating band overlaps proportional cooling band.

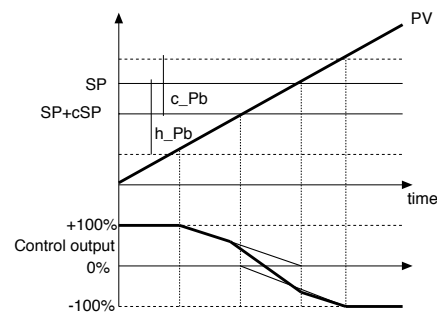

Control output with proportional action only if proportional heating band overlaps proportional cooling band.

PV = Process Value  
 SP+cSP = cooling setpoint  
 c\_Pb = Proportional cooling band

SP = Heating Setpoint  
 h\_Pb = proportional heating band

## 13 · TECHNICAL SPECIFICATIONS

Display	2x4 digit green LED's, digit height 10mm and 7mm
Keys	4 mechanical keys (Man/Aut, INC, DEC, F)
Accuracy	0.2% f.s. ±1 digit at 25°C ambient temperature
Main input	TC, RTD (Pt100)
Thermocouples	IEC 584-1 (J, K, R, S, T, B, E, N)
Cold junction error	0,1° / °C
RTD type (scale configurable within indicated range, with or without decimal point) Max. RTD line resistance	DIN 43760 (Pt100) 20Ω
Safety	Detection of short circuit or opening of sensors, LBA alarm
°C / °F selection	Faceplate configurable
Control actions	Pid, Autotune, on-off
pb	0,0...999,9 %
dt	0,00...99,99 min
di	0,00...99,99 min
Action	Heat or cool
Control outputs	on/off
Limitation Max power heat / cool	0,0...100,0 %
Cycle time	0...200 sec
Type of output	Relay, logic
Softstart	0,0...500,0 min
Fault power setting	-100,0...100,0 %
Power off function	Maintains PV display; can be excluded
Configurable alarms	Up to 3 alarm functions assignable to an output and configurable as: maximum, minimum, symmetrical, absolute/relative, LBA
Alarm masking	Exclude on power-up
Relay contact	NO (NC), 5A, 250Vac/30Vdc cosφ = 1
Logic output for static relays	24Vdc (10V min a 20mA)
Power supply	(standard) 100...240Vac ±10%, (optional) 11...27Vac/dc ±10% 50/60Hz, max 10VA
Faceplate protection	IP65
Working / Storage temperatures	0...50°C/-20...70°C
Relative humidity	20...85% Ur non condensing
Environmental conditions of use	For internal use only, altitude up to 2000m
Installation	Panel mounting, extractable from front
Weight	160g for the complete version

## · Interface for GEFRAN instrument configuration

KIT PC USB / RS485 o TTL



Kit for PC via the USB port (Windows environment) for GEFRAN instruments configuration:

Lets you read or write all of the parameters

- A single software for all models
- Easy and rapid configuration
- Saving and management of parameter recipes
- On-line trend and saving of historical data

Component Kit:

- Connection cable PC USB ... port TTL
- Connection cable PC USB ... RS485 port
- Serial line converter
- CD SW GF Express installation

## · ORDERING CODE

GF_eXK-2-0-0	cod F049095
--------------	-------------

## ORDER CODE

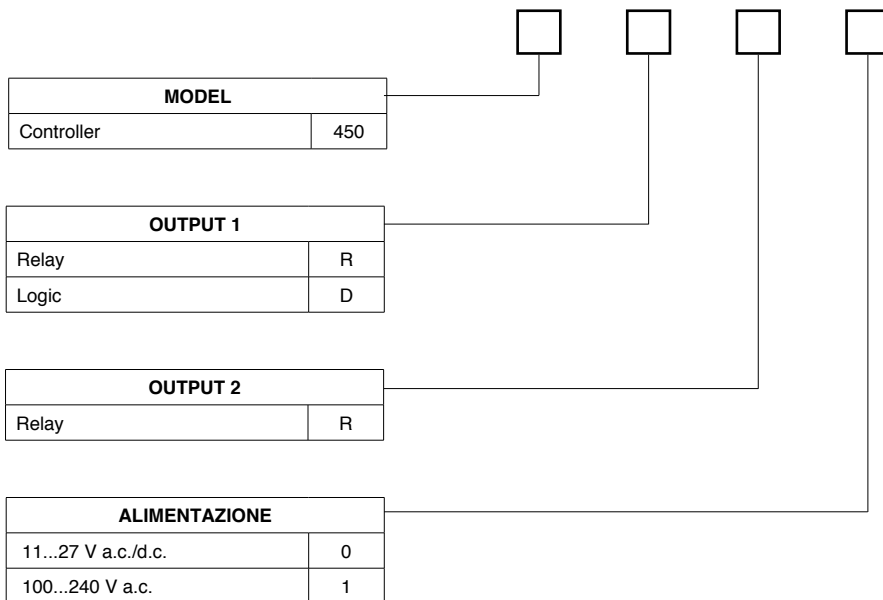

Model	Description	Code
450-D-R-1	1 Logic output, 1 Relay output, power supply 100...240VAC	F056773
450-R-R-1	2 Relay outputs, power supply 100...240VAC	F056774
450-D-R-0	1 Logic output, 1 Relay output, power supply 11...27VAC/DC	F056775
450-R-R-0	2 Relay outputs, power supply 11...27VAC/DC	F056776