

# 附件

45-  
450.1801

分销方  
Rs-online

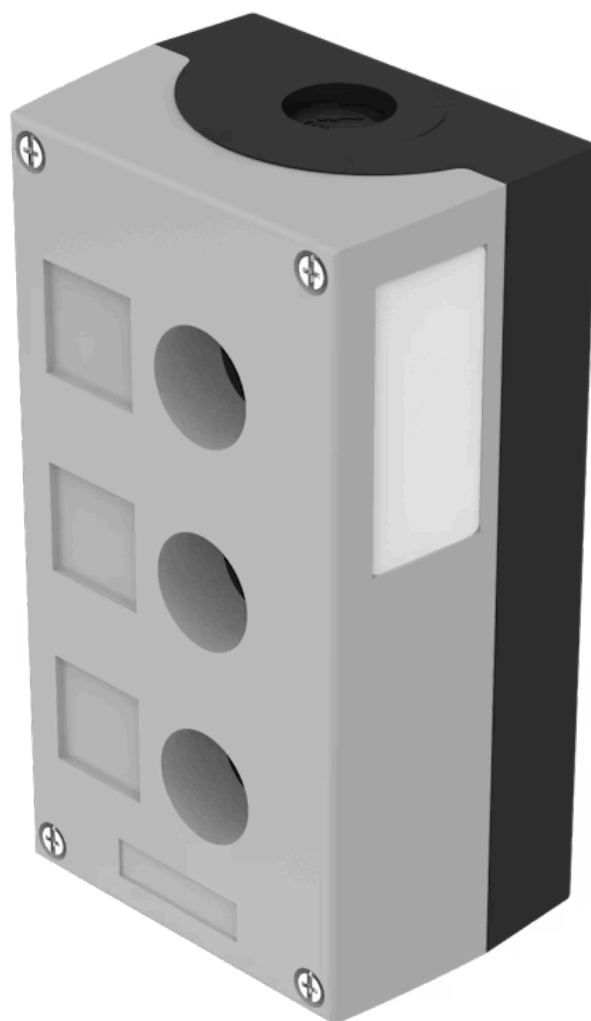

<https://rs-online.eao.com/component/45-450.18...>

您的产品:

---



## 45-450.1801 附件

### 正面

颜色: 灰色

### 机械特性

重量: 0.364 kg

### 环境条件

IP保护: IP66 , IP67 , IP69K

### 其他

简述: 附件, 154 mm x 85 mm x 64 mm, 塑料, 灰色

标题附件: 附件

尺寸: 154 mm x 85 mm x 64 mm

材质: 塑料

产品属性: 3个 $\phi$ 22.3mm安装孔, 顶部和底部1×M20

安装开孔:

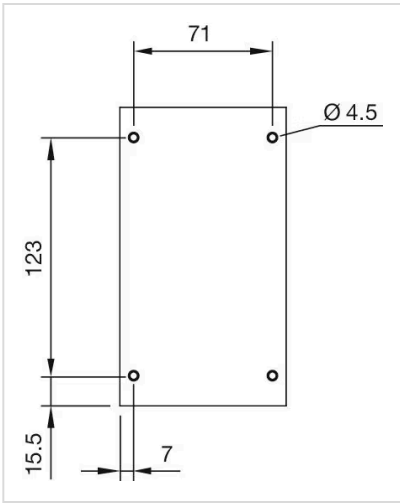

外形尺寸:

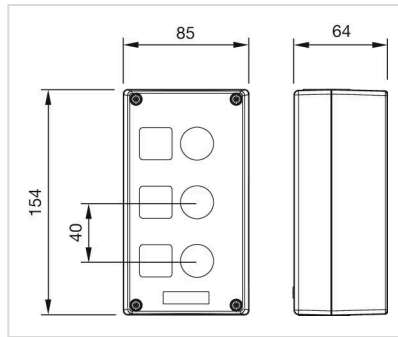

对于 Part No. 45-450.1801