

Tertiary/Industrial application



FLC09811

Boxes, equipment and various components

IP44 and IP55 junction boxes in thermoplastic material with press-on lid

Technical characteristics

- Protection degree
 - IP44 for press-on lid boxes with cable glands
 - IP55 for screw-on lid boxes with cable glands
 - IP55 for screw-on lid box with smooth sides
 - Available in RAL 7035 grey
 - IP44 boxes with press-on lids in thermoplastic material, self-extinguishing in compliance with UL 94 HB Standard and resistant to abnormal heat and fire up to 650°C (glow wire flammability index) in compliance with IEC 60695-2-11 Standard
 - IP55 boxes with press-on lids and cable glands in thermoplastic material, self-extinguishing in compliance with UL 94 HB Standard and resistant to abnormal heat and fire up to 650°C (glow wire flammability index) in compliance with IEC 60695-2-11 Standard
 - IP55 boxes with press-on lids and smooth sides in halogen free thermoplastic material, self-extinguishing in compliance with UL 94 HB Standard and resistant to abnormal heat and fire up to 650°C (glow wire flammability index) in compliance with IEC 60695-2-11 Standard
- Installation temperature from -25°C to +60°C
 - Resistant to heat:
 - ball thermopressure up to +85°C
 - Shock resistant:
 - IK08 for IP55 and IP65 boxes with 650°C GWT
 - High resistance to heat and chemical and atmospheric agents
 - Boxes with protection degree IP55 are composed of a patented lid produced in a single pressing phase together with its seal
 - All the boxes with cable-way inlets are suitable to be installed with mini-trunking by using special connectors ABB
 - When fitted with special housings, the base of the box can be equipped with terminals and various accessories
- Junction boxes made in compliance with IEC 60670-1 and IEC 60670-22 Standards
 - Use 3,5x9,5 self-tapping screws to fix the components on the back
 - All the boxes are RoHS compliance

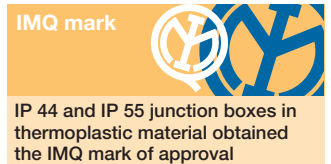
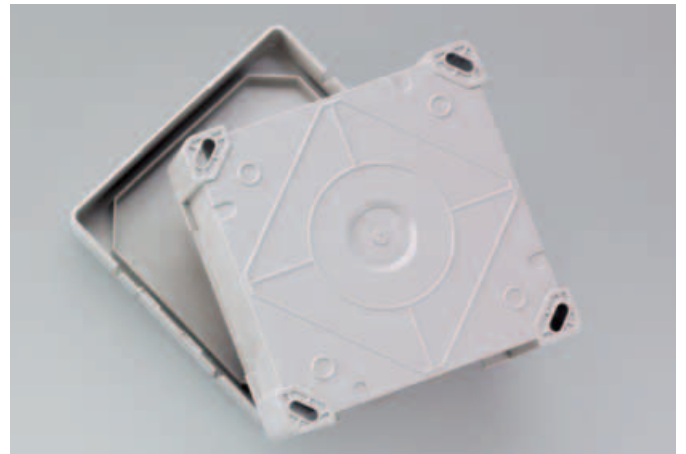

Boxes, equipment and various components

IP44 and IP55 junction boxes in thermoplastic material with press-on lid

Box 100x100x50

With press-on lids 100x100x50

With press-on lids 100x100x50



Code	Degree of protection	Description
1SL0811A00	IP44	with cable glands
1SL0890A00	IP55	with cable glands

Code	Degree of protection	Description
1SL0891A00	IP55	with smooth sides

Boxes, equipment and various components

IP44, IP55 and IP65 junction boxes in thermoplastic material

Technical characteristics

- Protection degree
 - IP44 for press-on lid boxes with cable glands
 - IP55 for screw-on lid boxes with cable glands
 - IP65 for screw-on lid box with smooth sides
 - Available in RAL 7035 grey
 - IP44 boxes with press-on lids in thermoplastic material, self-extinguishing in compliance with UL 94 HB Standard and resistant to abnormal heat and fire up to 650°C (glow wire flammability index) in compliance with IEC 60695-2-11 Standard
 - IP44 boxes with press-on lids in thermoplastic material, self-extinguishing in compliance with UL 94 V2 Standard and resistant to abnormal heat and fire up to 960°C (glow wire flammability index) in compliance with IEC 60695-2-11 Standard
 - IP55 boxes with screw-on lids in thermoplastic material, self-extinguishing in compliance with UL 94 HB Standard and resistant to abnormal heat and fire up to 650°C (glow wire flammability index) in compliance with IEC 60695-2-11 Standard
 - IP55 boxes with screw-on lids in thermoplastic material, self-extinguishing in compliance with UL 94 V2 Standard and resistant to abnormal heat and fire up to 960°C (glow wire flammability index) in compliance with IEC 60695-2-11 Standard
 - IP65 boxes with screw-on lids in **halogen free** thermoplastic material, self-extinguishing in compliance with UL 94 HB Standard and resistant to abnormal heat and fire up to 650°C (glow wire flammability index) in compliance with IEC 60695-2-11 Standard
 - IP65 boxes with screw-on lids in thermoplastic material, self-extinguishing in compliance with UL 94 V2 Standard
- and resistant to abnormal heat and fire up to 960°C (glow wire flammability index) in compliance with IEC 60695-2-11 Standard
- Installation temperature from -25°C to +60°C
 - Resistant to heat:
 - ball thermopressure up to +85°C for IP44 boxes with 650°C and 960°C GWT
 - ball thermopressure up to +85°C for IP55 and IP65 boxes with 650°C GWT
 - ball thermopressure up to +120°C for IP55 and IP65 boxes with 960°C GWT
 - Shock resistant:
 - IK07 for IP44 boxes
 - IK08 for IP55 and IP65 boxes with 650°C GWT
 - IK09 for IP55 and IP65 boxes with 960°C GWT
 - High resistance to heat and chemical and atmospheric agents
 - 3 lid types:
 - press-on
 - with steel screws
 - with plastic screws with a ¼ turn closing
 - Boxes with protection degree IP55 and IP65 are composed of a patented lid produced in a single pressing phase together with its seal
 - All the boxes with cable-way inlets are suitable to be installed with mini-trunking by using special connectors ABB
 - When fitted with special housings, the base of the box can be equipped with terminals and various accessories
 - Boxes measuring 160x135, 220x170 and 310x240 mm can be mounted on the wall with brackets code 12858
 - Junction boxes made in compliance with IEC 60670-1 and IEC 60670-22 Standards
 - Use 3,5x9,5 self-tapping screws to fix the components on the back
 - All the boxes are RoHS compliance



1SLCC01089F0001



1SLCC01089F0001

IMQ mark



IP 44 and IP 55 junction boxes in thermoplastic material obtained the IMQ mark of approval

Boxes, equipment and various components

IP 44, IP 55 and IP 65 junction boxes in thermoplastic material

IP 44 boxes - GWT 650 °C

With cable glands and press-on lid



Code	Internal dimensions (mm)	Box/pack No items
00 800	Ø 60 - H 35	240/240
00 802	Ø 80 - H 40	144/144
00 808	65x65x32	168/168
00 810	80x80x40	100/100

6

IP 55 waterproof boxes with plastic 1/4 turn screws - GWT 650 °C

With cable glands and low screw-on lid RAL 7035



Code	Internal dimensions (mm)	Box/pack No items
1SL0816A00	100x100x50	1/54
1SL0820A00	105x70x50	1/70
1SL0821A00	100x100x80	1/40
1SL0822A00	153x110x66	1/32
1SL0824A00(*)	160x135x77	1/18
1SL0826A00(*)	220x170x80	1/12
1SL0828A00(*)	310x240x110	1/6

(*) Can be wall-mounted using wall brackets code 12 858.

IP 65 waterproof boxes with plastic 1/4 turn screws - GWT 650 °C halogen free

With smooth sides and low screw-on lid RAL 7035

With smooth sides and transparent low screw-on lid



Code	Internal dimensions (mm)	Box/pack No items
1SL0846A00	100x100x50	1/60
1SL0850A00	105x70x50	1/100
1SL0851A00	100x100x80	1/40
1SL0852A00	153x110x66	1/32
1SL0854A00(*)	160x137x77	1/24
1SL0856A00(*)	220x170x80	1/12
1SL0858A00(*)	310x240x110	1/6

(*) Can be wall-mounted using wall brackets code 12 858.



Code	Internal dimensions (mm)	Box/pack No items
1SL0872A00	153x110x66	1/34
1SL0874A00(*)	160x135x77	1/24
1SL0876A00(*)	220x170x80	1/12
1SL0878A00(*)	310x240x110	1/6

(*) Can be wall-mounted using wall brackets code 12 858.

Boxes, equipment and various components

IP 44, IP 55 and IP 65 junction boxes in thermoplastic material

IP 55 waterproof boxes with steel screws - GWT 650 °C

With cable glands and high screw-on lid RAL 7035



FLC09198

Code	Internal dimensions (mm)	Box/pack No items
00 816	100x100x50	1/54
00 820	105x70x50	1/70
00 821	100x100x80	1/40
00 822	153x110x66	1/32

IP 65 waterproof boxes with steel screws - GWT 650 °C halogen free

With smooth sides and high screw-on lid RAL 7035



FLC09204

Code	Internal dimensions (mm)	Box/pack No items
00 846	100x100x50	1/60
00 850	105x70x50	1/100
00 851	100x100x80	1/40
00 852	153x110x66	1/34

With smooth sides and transparent high screw-on lid



1SLC001031F001

Code	Internal dimensions (mm)	Box/pack No items
00 872	151x110x66	1/34

IP 55 waterproof boxes with plastic 1/4 turn screws - GWT 650 °C

With cable glands and high screw-on lid RAL 7035



1SLC001088F001

Code	Internal dimensions (mm)	Box/pack No items
1SL0830A00	160x135x150	1/16
1SL0832A00	220x170x150	1/8
1SL0834A00	310x240x160	1/4

IP 65 waterproof boxes with plastic 1/4 turn screws - GWT 650 °C halogen free

With smooth sides and high screw-on lid RAL 7035



1SLC001087F001

Code	Internal dimensions (mm)	Box/pack No items
1SL0860A00	160x135x150	1/16
1SL0862A00	220x170x150	1/8
1SL0864A00	310x240x160	1/4

With smooth sides and transparent high screw-on lid



1SLC001088F001

Code	Internal dimensions (mm)	Box/pack No items
1SL0880A00(*)	160x135x150	1/16
1SL0882A00(*)	220x170x150	1/8
1SL0884A00(*)	310x240x160	1/4

(*) Can be wall-mounted using wall brackets code 12 858.

Boxes, equipment and various components

IP 44, IP 55 and IP 65 junction boxes in thermoplastic material

IP 44 boxes - GWT 960 °C

With cable glands and press-on lid

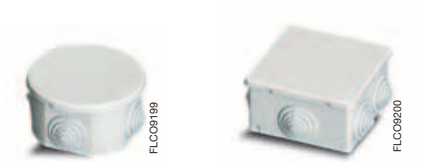

Code	Internal dimensions (mm)	Box/pack No items
1SL0900A00	Ø 60 - H 35	240/240
1SL0901A00	Ø 80 - H 40	144/144
1SL0902A00	65x65x32	168/168
1SL0903A00	80x80x40	100/100

6

IP 55 waterproof boxes with plastic 1/4 turn screws - GWT 960 °C

With cable glands and low screw-on lid RAL 7035



Code	Internal dimensions (mm)	Box/pack No items
1SL0916A00	100x100x50	1/54
1SL0920A00	105x70x50	1/70
1SL0921A00	100x100x80	1/40
1SL0922A00	153x110x66	1/32
1SL0924A00(*)	160x135x77	1/18
1SL0926A00(*)	220x170x80	1/12
1SL0928A00(*)	310x240x110	1/6

(*) Can be wall-mounted using wall brackets code 12 858.

IP 65 waterproof boxes with plastic 1/4 turn screws - GWT 960 °C

With smooth sides and low screw-on lid RAL 7035

With smooth sides and transparent low screw-on lid



Code	Internal dimensions (mm)	Box/pack No items
1SL0946A00	100x100x50	1/60
1SL0950A00	105x70x50	1/100
1SL0951A00	100x100x80	1/40
1SL0952A00	153x110x66	1/32
1SL0954A00(*)	160x137x77	1/24
1SL0956A00(*)	220x170x80	1/12
1SL0958A00(*)	310x240x110	1/6

(*) Can be wall-mounted using wall brackets code 12 858.



Code	Internal dimensions (mm)	Box/pack No items
1SL0972A00	153x110x66	1/34
1SL0974A00(*)	160x135x77	1/24
1SL0976A00(*)	220x170x80	1/12
1SL0978A00(*)	310x240x110	1/6

(*) Can be wall-mounted using wall brackets code 12 858.

Boxes, equipment and various components

IP 44, IP 55 and IP 65 junction boxes in thermoplastic material

IP 55 waterproof boxes with steel screws - GWT 960 °C

With cable glands and high screw-on lid RAL 7035



FLC09198

Code	Internal dimensions (mm)	Box/pack No items
1SL0904A00	100x100x50	1/54
1SL0905A00	105x70x50	1/70
1SL0906A00	100x100x80	1/40
1SL0907A00	153x110x66	1/32

IP 65 waterproof boxes with steel screws - GWT 960 °C

With smooth sides and high screw-on lid RAL 7035



FLC09204

Code	Internal dimensions (mm)	Box/pack No items
1SL0908A00	100x100x50	1/60
1SL0909A00	105x70x50	1/100
1SL0910A00	100x100x80	1/40
1SL0911A00	153x110x66	1/34

With smooth sides and transparent high screw-on lid



1SLC091031F001

Code	Internal dimensions (mm)	Box/pack No items
1SL0912A00	151x110x66	1/34

IP 55 waterproof boxes with plastic 1/4 turn screws - GWT 960 °C

With cable glands and high screw-on lid RAL 7035



1SLC091088F001

Code	Internal dimensions (mm)	Box/pack No items
1SL0930A00	160x135x150	1/16
1SL0932A00	220x170x150	1/8
1SL0934A00	310x240x160	1/4

IP 65 waterproof boxes with plastic 1/4 turn screws - GWT 960 °C

With smooth sides and high screw-on lid RAL 7035



1SLC091087F001

Code	Internal dimensions (mm)	Box/pack No items
1SL0960A00	160x135x150	1/16
1SL0962A00	220x170x150	1/8
1SL0964A00	310x240x160	1/4

With smooth sides and transparent high screw-on lid



1SLC091088F001

Code	Internal dimensions (mm)	Box/pack No items
1SL0980A00(*)	160x135x150	1/16
1SL0982A00(*)	220x170x150	1/8
1SL0984A00(*)	310x240x160	1/4

(*) Can be wall-mounted using wall brackets code 12 858.

Boxes, equipment and various components

Accessories for IP 44, IP 55 and IP 65 junction boxes in thermoplastic material

Cable glands and nuts - PG pitch



Code		Pitch	Torque values N x m	Cable clamp Box/pack No items	For cables diameter		Nuts x cable Box/pack No items
cable gland	nut x cable gland	Pg			Min. (mm)	Max. (mm)	
00 931	00 941	9	3.75	100/500	6.5	8.5	100/3000
00 932	00 942	11	3.75	100/500	8	10	100/3000
00 933	00 943	13.5	3.75	50/500	8	11	50/1500
00 934	00 944	16	5	50/300	11	14	50/1500
00 935	00 945	21	7.5	50/300	14.5	18	50/1500
00 936	00 946	29	7.5	25/150	19	26	50/600
00 937	00 947	36	7.5	25/75	30	34	25/300
00 938	00 948	42	7.5	15/60	30	38	25/300

In compliance with CEI EN 50262 Standard.

Cable glands and nuts - metric pitch



Code		Pitch	Torque values N x m	Cable diameter		Box/pack No items	Cable clamp Box/pack No items
cable gland	nut	M		Min. (mm)	Max. (mm)		
00 951	00 961	12 x 1.5	2.7	3.5	7	100/1200	100/3000
00 952	00 962	16 x 1.5	5	5.5	10	100/500	100/3000
00 953	00 963	20 x 1.5	7	7	13	100/500	50/1500
00 954	00 964	25 x 1.5	7.5	10	17	50/250	50/1500
00 955	00 965	32 x 1.5	8	12	21	25/150	50/500
00 956(*)	00 966	40 x 1.5	8	19	28	25/75	25/300
00 957(*)	00 967	50 x 1.5	10	27	35	15/60	25/300
00 958(*)	00 968	63 x 1.5	10	34	45	10/40	20/100

(*) Cable clamps and M40, M50 and M63 nuts are available on request.
In compliance with CEI EN 50262 Standard.

Technical characteristics of metric cable clamps

Protection degree IP 68
Material: polyamide 6.6, self-extinguishing material according to UL94 V2 Standard and resistant to abnormal heat and to fire up to 750 °C (glow wire test) according to IEC 60695-2-11 Standard
Operational temperature: from -20 °C up to +120 °C (short period of time)
Colour: RAL 7035 grey
Thread pitch: 1.5 mm
Thread angle: 60°
Neoprene seal
Tightening with a plate crown on the whole diameter of cable (excluded the possibility to damage the cable itself)
Possibility to recover the cable clamp without compromising its efficiency.

Technical characteristics nuts of with metric pitch collar

Material: polyamide 6.6, self-extinguishing material according to UL94 V2 Standard and resistant to abnormal heat and to fire up to 750 °C (glow wire test) according to IEC 60695-2-11 Standard
Operational temperature: from -20 °C up to +120 °C (continuous) from -20 °C up to +120 °C (short period of time)
Colour: RAL 7035 grey
Thread pitch: 1.5 mm
Thread angle: 60°.

Boxes, equipment and various components

Accessories for IP 44, IP 55 and IP 65 junction boxes in thermoplastic material

Metal base plates

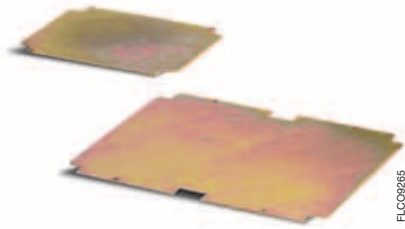

Code	Dimensions (mm)	Box/pack No items
00 900	160 x 135 x 77	1/10
00 902	220 x 170 x 80	1/5
00 904	310 x 240 x 110	1/5

All metal base plates listed above are equipped with fixing screws type 3.5x9.5.

Cable clamps

Protection degree: IP 55



Code	For conduit Ø (mm)	Box/pack No items
00 908	20	100/1500
00 910	25	100/1000
00 912	32	50/400

Conduit clamps - Box connector

Protection degree: IP 67



Code	For conduit Ø (mm)	Box/pack No items
00 430	16	500/500
00 431	20	300/300
00 432	25	150/150
00 433	32	100/100
00 434	40	50/50
00 435	50	50/50

Unions

Protection degree: IP 55



Code	Ø (mm)	Box/pack No items
13 874	23	10/500
13 875	28.5	100/400
13 876	37	100/200

Overall dimensions

IP 44 and IP 55 junction boxes in thermoplastic material

Drilling sheets and internal dimensions

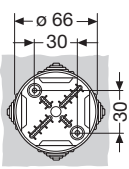

00 800 - 00 581
1SL0900A00
1SL0910A00

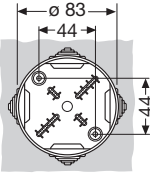

00 802
1SL0901A00

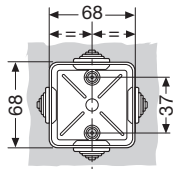

00 808
1SL0902A00

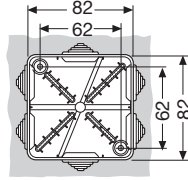

00 810
1SL0903A00

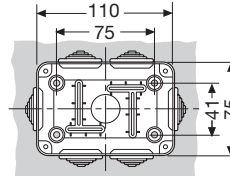

00 820 - 00 850
1SL0820A00
1SL0850A00
1SL0905A00
1SL0909A00
1SL0920A00
1SL0950A00

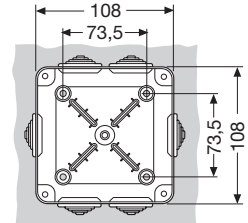

00 816 - 00 846
1SL0816A00
1SL0846A00
1SL0904A00
1SL0908A00
1SL0916A00
1SL0946A00

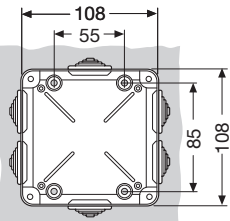

00 821 - 00 851
1SL0821A00
1SL0851A00
1SL0906A00
1SL0910A00
1SL0921A00
1SL0951A00

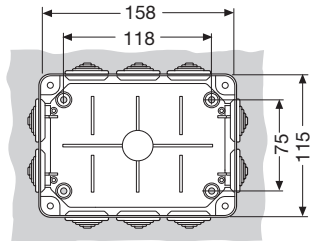

00 822 - 00 852 - 00 872
1SL0822A00 - 1SL0852A00 - 1SL0872A00
1SL0907A00 - 1SL0911A00 - 1SL0912A00
1SL0922A00 - 1SL0952A00 - 1SL0972A00

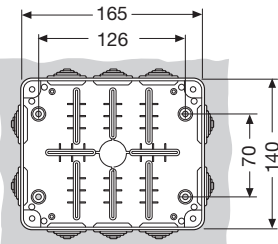

1SL0824A00 - 1SL0830A00
1SL0874A00 - 1SL0854A00
1SL0860A00 - 1SL0880A00
1SL0924A00 - 1SL0930A00
1SL0974A00 - 1SL0954A00
1SL0960A00 - 1SL0980A00

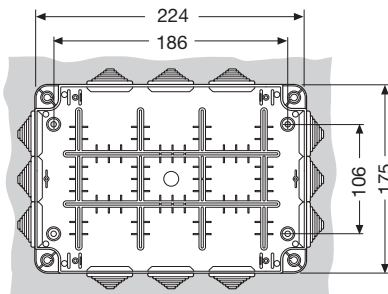

1SL0826A00 - 1SL0832A00
1SL0876A00 - 1SL0856A00
1SL0862A00 - 1SL0884A00
1SL0926A00 - 1SL0932A00
1SL0976A00 - 1SL0956A00
1SL0962A00 - 1SL0984A00

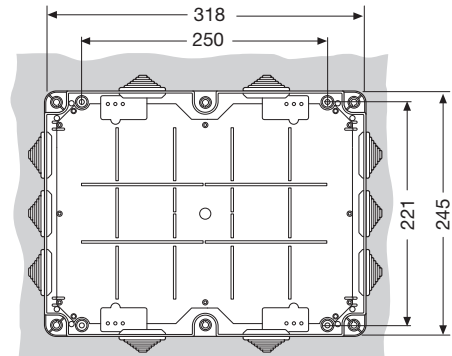

1SL0828A00 - 1SL0834A00
1SL0878A00 - 1SL0858A00
1SL0864A00 - 1SL0884A00
1SL0928A00 - 1SL0934A00
1SL0978A00 - 1SL0958A00
1SL0964A00 - 1SL0984A00

Overall dimensions

IP 44 and IP 55 junction boxes in thermoplastic material

Front view

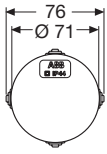

00 800
1SL0900A00

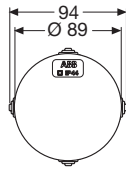

00 802
1SL0901A00

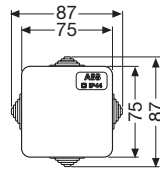

00 808
1SL0902A00

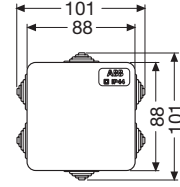

00 810
1SL0903A00

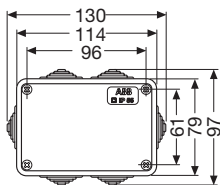

00 820 - 00 850
1SL0820A00 - 1SL0850A00
1SL0905A00 - 1SL0909A00
1SL0920A00 - 1SL0950A00

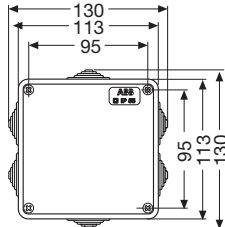

00 816 - 00 821
00 846 - 00 851
1SL0816A00 - 1SL0821A00
1SL0846A00 - 1SL0851A00
1SL0904A00 - 1SL0906A00
1SL0908A00 - 1SL0910A00
1SL0916A00 - 1SL0921A00
1SL0946A00 - 1SL0951A00

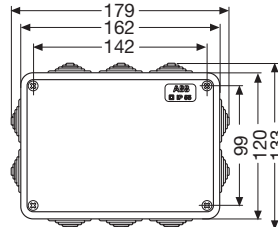

00 822 - 00852 - 00 872
1SL0822A00 - 1SL0852A00
1SL0872A00 - 1SL0907A00
1SL0911A00 - 1SL0912A00
1SL0922A00 - 1SL0985A00
1SL0972A00

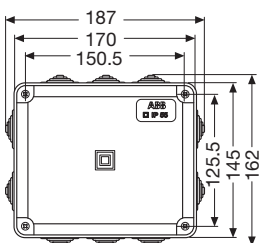

1SL0830A00 - 1SL0824A00
1SL0874A00 - 1SL0854A00
1SL0860A00 - 1SL0880A00
1SL0930A00 - 1SL0924A00
1SL0974A00 - 1SL0954A00
1SL0960A00 - 1SL0980A00

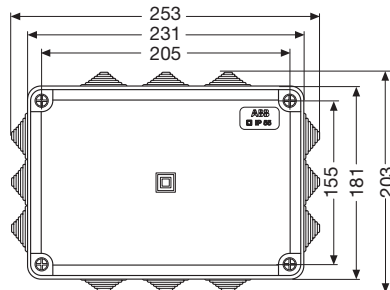

1SL0826A00 - 1SL0832A00
1SL0876A00 - 1SL0856A00
1SL0862A00 - 1SL0884A00
1SL0926A00 - 1SL0932A00
1SL0976A00 - 1SL0956A00
1SL0962A00 - 1SL0984A00

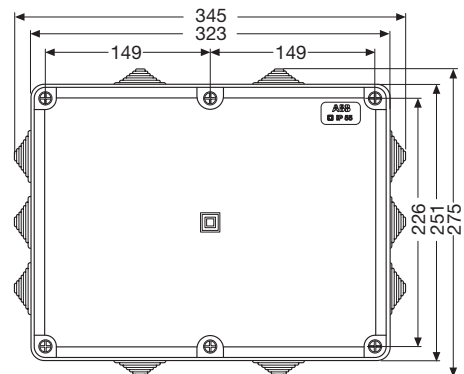

1SL0828A00 - 1SL0834A00
1SL0878A00 - 1SL0858A00
1SL0864A00 - 1SL0884A00
1SL0928A00 - 1SL0934A00
1SL0978A00 - 1SL0958A00
1SL0964A00 - 1SL0984A00

10