

PicoScope[®] 5000 Series

Flexible resolution oscilloscopes



8 to 16 bit selectable hardware resolution

Up to 200 MHz analog bandwidth

Up to 512 MS buffer memory

Up to 1 GS/s real-time sampling

Up to 10 GS/s equivalent-time sampling

Up to 200 MHz spectrum analyzer

Built-in function generator or AWG

USB-connected

SDK available with example programs • Free technical support
Free software updates • Software compatible with Windows 7, 8 and 10

PicoScope: power, portability and versatility

Pico Technology continues to push the limits of PC oscilloscope design. For the first time in an oscilloscope, Pico Technology have used reconfigurable ADCs to offer a choice of 8-bit to 16-bit resolutions in a single product.

Flexible resolution

Most digital oscilloscopes gain their high sampling rates by interleaving multiple 8-bit ADCs. Despite careful design, the interleaving process introduces errors that always make the dynamic performance worse than the performance of the individual ADC cores.

The new PicoScope 5000 Series scopes have a significantly different architecture in which multiple high-resolution ADCs can be applied to the input channels in different time-interleaved and parallel combinations to boost either the sampling rate or the resolution.

In time-interleaved mode, the ADCs are interleaved to provide 1 GS/s at 8 bits (see left diagram). Interleaving reduces the performance of the ADCs, but the resulting (60 dB SFDR) is still much better than oscilloscopes that interleave 8-bit ADCs. This mode can also provide 500 MS/s at 12 bits resolution.

In parallel mode, multiple ADCs are sampled in phase on each channel to increase the resolution and dynamic performance (see right diagram). Sampling in parallel with multiple ADCs and combining the output reduces noise and also both the integral and differential nonlinearity. Using parallel mode, resolution is increased to 14 bits at 125 MS/s per channel (70 dB SFDR). If only two channels are required then resolution can be increased to 15 bits, and in single-channel mode all the ADCs are combined to give a 16-bit mode at 62.5 MS/s. The software gives the choice of selecting the resolution or leaving the scope in “auto resolution” mode where the optimum resolution is used for the chosen settings.

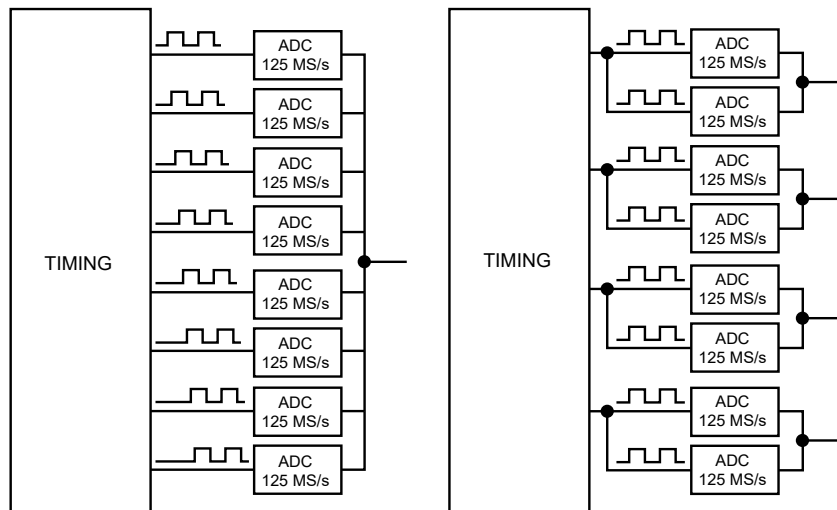

High bandwidth, high sampling rate

Most USB-powered oscilloscopes have real-time sampling rates of only 100 or 200 MS/s, but the PicoScope 5000 Series offers up to 1 GS/s, and a maximum bandwidth of 200 MHz. Equivalent time sampling (ETS) mode can be used to further boost the sampling rate to 10 GS/s for a more detailed view of repetitive signals.

Digital triggering

Most digital oscilloscopes sold today still use an analog trigger architecture based on comparators. This can cause time and amplitude errors that cannot always be calibrated out. The use of comparators often limits the trigger sensitivity at high bandwidths.

In 1991 we pioneered the use of fully digital triggering using the actual digitized data. This technique reduces trigger errors and allows our oscilloscopes to trigger on the smallest signals, even at the full bandwidth. Trigger levels and hysteresis can be set with high precision and resolution.

Digital triggering also reduces re-arm delay and this, combined with the segmented memory, allows the triggering and capture of events that happen in rapid sequence. At the fastest timebase you can use rapid triggering to collect 10,000 waveforms in under 20 milliseconds. Our mask limit testing function can then scan through these waveforms to highlight any failed waveforms for viewing in the waveform buffer.

Huge buffer memory

The PicoScope 5000 Series offers memory depths up to 512 million samples, more than any other oscilloscope in this price range.

Other oscilloscopes have high maximum sampling rates, but without deep memory they cannot sustain these rates on long timebases. Using its 512 MS buffer, the PicoScope 5444B can sample at 1 GS/s all the way down to 50 ms/div (500 ms total capture time).

Managing all this data calls for some powerful tools. There's a set of zoom buttons, plus an overview window that lets you zoom and reposition the display by simply dragging with the mouse. Zoom factors of several million are possible.

Each captured waveform is stored in a segmented buffer so you can rewind and review up to 10,000 previous waveforms. No longer will you see a glitch on the screen only for it to vanish before you stop the scope. A mask can be applied to hide waveforms that are not of interest.

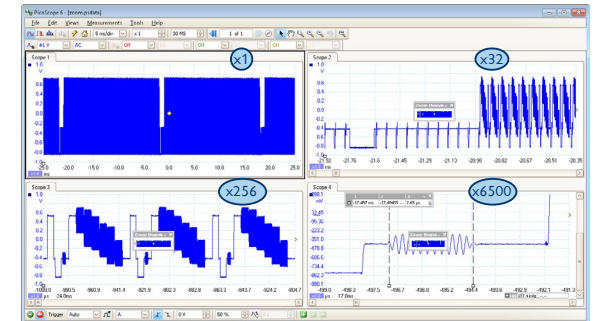

Advanced triggers

As well as the standard range of triggers found on all oscilloscopes, the PicoScope 5000 Series offers an industry-leading set of advanced triggers including pulse width, windowed and dropout triggers to help you capture the data you need.

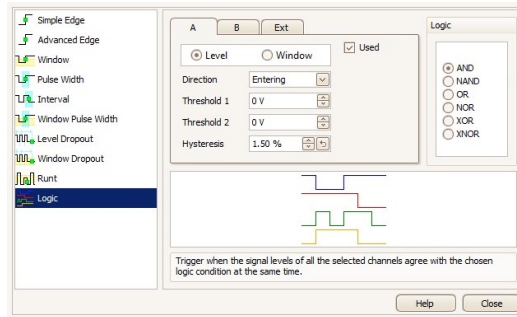

Arbitrary waveform and function generator

All units have a built-in function generator. As well as basic controls to set level, offset and frequency, more advanced controls allow you to sweep over a range of frequencies. Combined with the spectrum peak hold option this makes a powerful tool for testing amplifier and filter responses.

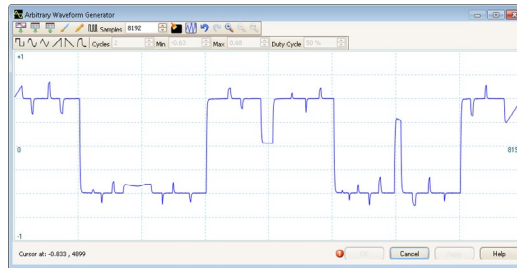

The PicoScope 5000 Series B models include an arbitrary waveform generator. Waveforms can be created or edited using the built-in AWG editor, imported from oscilloscope traces, or loaded from a spreadsheet.

Serial decoding

The PicoScope 5000 Series, with its deep memory, is ideal for serial decoding as it can capture thousands of frames of uninterrupted data. Protocols currently included are I²C, SPI, RS-232/UART, CAN, LIN and FlexRay. Expect this list to grow with free software updates.

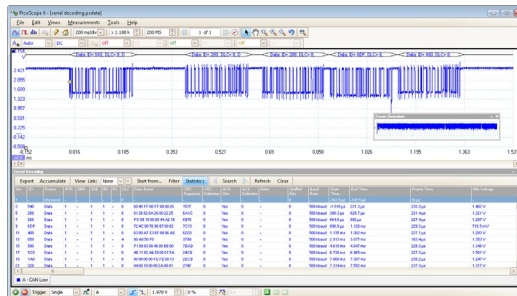

High-end features as standard

Buying a scope from some companies is a bit like buying a car. By the time you have added all the optional extras you need, the price has gone up considerably. With the PicoScope 5000 Series, high-end features such as mask limit testing, serial decoding, advanced triggering, measurements, math, XY mode, digital filtering and segmented memory are all included in the price.

To protect your investment, both the PC software and firmware inside the unit can be updated. We have a long history of providing new features for free as software downloads. Other companies make vague promises about future enhancements but we deliver on our promises year after year. Users of our products reward us by becoming lifelong customers, frequently recommending us to their colleagues.

The design of the PicoScope software ensures that maximum display area is available for waveform viewing. Even with a laptop you have a much bigger viewing area and higher resolution than a typical benchtop scope.

High signal integrity

Most oscilloscopes are built down to a price; ours are built up to a specification.

Careful front-end design and shielding reduces noise, crosstalk and harmonic distortion. Years of oscilloscope experience leads to improved pulse response and bandwidth flatness.

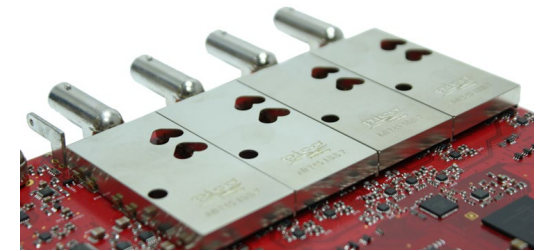

Persistence display modes

See old and new data superimposed, with new data in a brighter color or shade. This makes it easy to see glitches and dropouts and to estimate their relative frequency. Choose between analog persistence and digital color, or create a custom display mode.

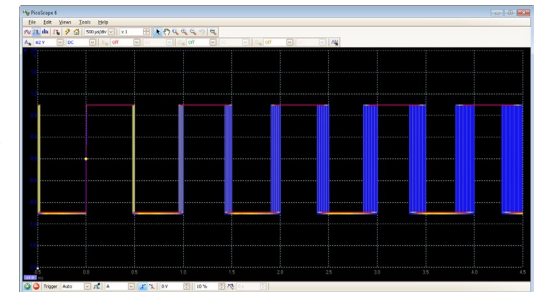

Mask limit testing

This feature is specially designed for production and debugging environments. Capture a signal from a known working system, and PicoScope will draw a mask around it with your specified tolerance. Connect the system under test, and PicoScope will highlight any parts of the waveform that fall outside the mask area. The highlighted details persist on the display, allowing the scope to catch intermittent glitches while you work on something else. The measurements window counts the number of failures, and can display other measurements and statistics at the same time. You can import and export masks as files.

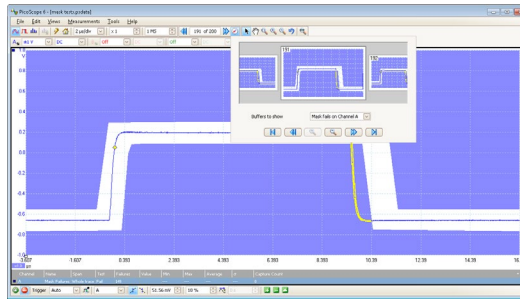

Spectrum analyzer

With a click of a button, you can display a spectrum plot of the selected channels with a maximum frequency up to 200 MHz. A full range of settings gives you control over the number of spectrum bands, window types and display modes: instantaneous, average, or peak-hold.

You can display multiple spectrum views with different channel selections and zoom factors, and see these alongside time-domain waveforms of the same data. A comprehensive set of automatic frequency-domain measurements, including THD, THD+N, SNR, SINAD and IMD, can be added to the display.

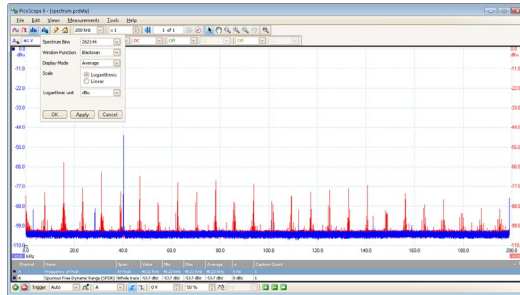

Math channels

Create new channels by combining input channels and reference waveforms. Choose from a wide range of arithmetic, logarithmic, trigonometric and other functions. Define a function using the push-button control panel or type an equation in the text box.

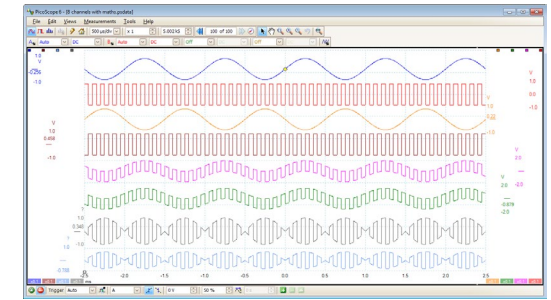

High-speed data acquisition/digitizer

The drivers and software development kit supplied allow you to write your own software or interface to popular third-party software packages such as LabVIEW.

If the scope's ultra-deep memory isn't enough, the driver supports data streaming, a mode that captures gap-free continuous data through the USB port directly to the PC's RAM or hard disk at a rate of over 10 MS/s (maximum speed is PC-dependent).

Custom probe settings

The custom probes feature allows you to correct for gain, attenuation, offsets and nonlinearities in special probes, or to convert to different units of measurement (such as current, power or temperature). You can save definitions to disk for later use.

Portability

Pico Technology oscilloscopes are small, light and portable. In 2-channel mode the 5000 Series scopes can be powered from USB only, making them ideal for the engineer on the move. The external power supply is only needed when operating more than 2 channels. The 5000 Series oscilloscopes are suitable for field use in many applications, such as design, research, test, education, service and repair.

PicoScope 6 software

The display can be as simple or as complex as you need. Begin with a single view of one channel, and then expand the display to include any number of live channels, math channels and reference waveforms.

Tools: Including serial decoding, reference channels, macro recorder, alarms and mask limit testing.

Signal generator: Generates standard signals or (on selected scopes) arbitrary waveforms. Includes frequency sweep mode.

Waveform replay tools: PicoScope automatically records up to 10,000 of the most recent waveforms. You can quickly scan through to look for intermittent events, or use the **Buffer Navigator** to search visually.

Zoom and pan tools: PicoScope allows a zoom factor of several million, which is necessary when working with the deep memory of the 5000 Series scopes. Either use the zoom-in, zoom-out and pan tools, or click and drag in the zoom overview window for fast navigation.

Rulers: Each axis has two rulers that can be dragged across the screen to make quick measurements of amplitude, time and frequency.

Auto setup button: Configures the collection time and voltage range for stable display of signals.

Channel options: Filtering, offset, resolution enhancement, custom probes and more.

Oscilloscope controls: Controls such as voltage range, scope resolution, channel enable, timebase and memory depth.

Trigger marker: Drag to adjust trigger level and pre-trigger time.

Movable axes: The vertical axes can be dragged up and down. This feature is particularly useful when one waveform is obscuring another. There's also an **Auto Arrange Axes** command.

Spectrum view: View FFT data alongside scope view or independently.

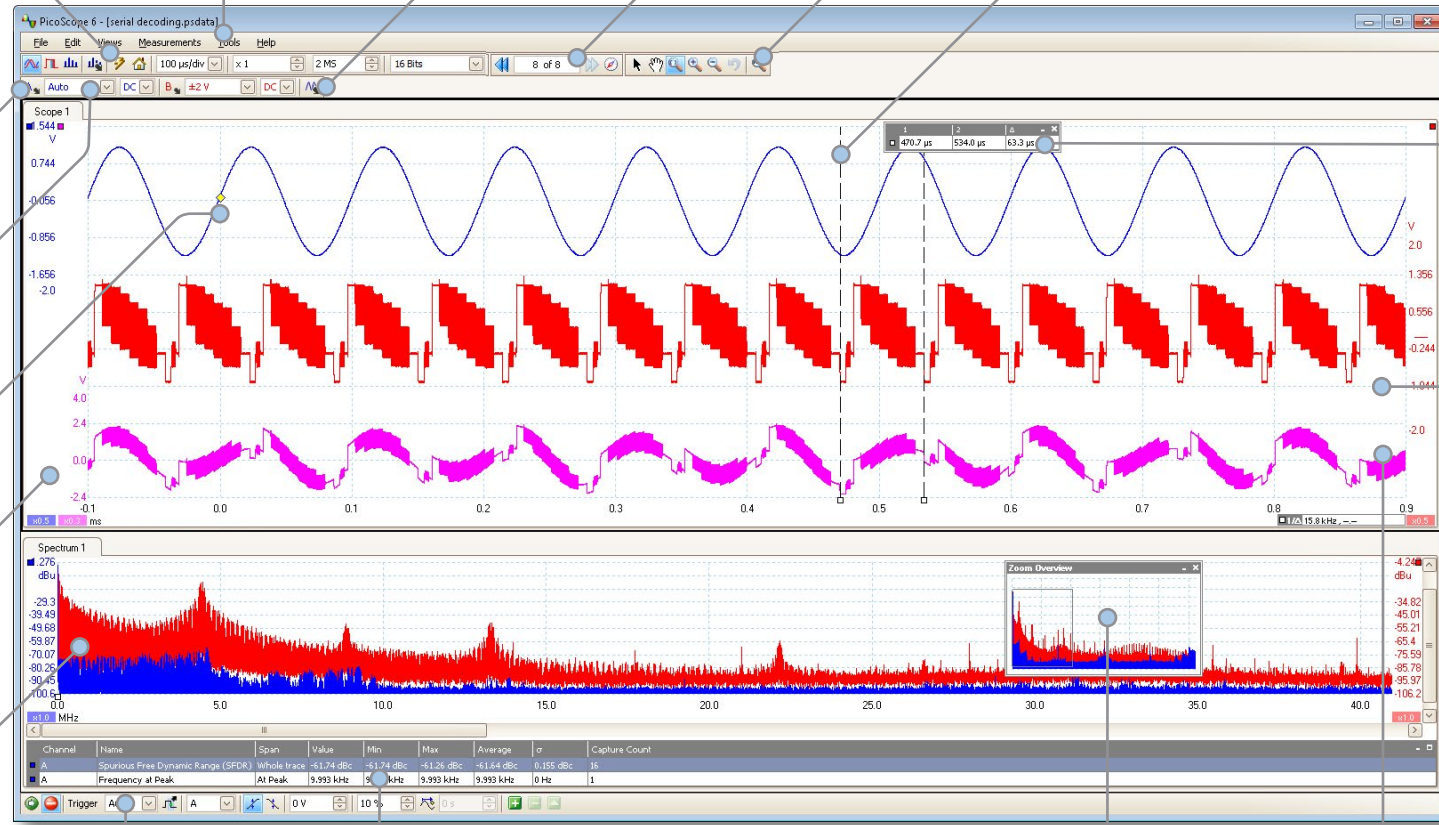

Trigger toolbar: Quick access to main controls, with advanced triggers in a pop-up window.

Automatic measurements: Display calculated measurements for troubleshooting and analysis. You can add as many measurements as you need on each view. Each measurement includes statistical parameters showing its variability.

Zoom overview: Click and drag for quick navigation in zoomed views.

Math channels: Combine input channels and reference waveforms using simple arithmetic, or create custom equations with trigonometric and other functions.

Ruler legend: Absolute and differential ruler measurements are listed here.

Views: PicoScope is carefully designed to make the best use of the display area. You can add new scope and spectrum views with automatic or custom layouts.

VERTICAL	PicoScope 5242A	PicoScope 5442A	PicoScope 5242B	PicoScope 5442B	PicoScope 5243A	PicoScope 5443A	PicoScope 5243B	PicoScope 5443B	PicoScope 5244A	PicoScope 5444A	PicoScope 5244B	PicoScope 5444B
Number of channels	2	4	2	4	2	4	2	4	2	4	2	4
Bandwidth (-3 dB)	60 MHz				100 MHz (except 16-bit mode: 60 MHz)				200 MHz (except 16-bit mode: 60 MHz)			
Bandwidth limiting (-3 dB)	20 MHz, switchable											
Rise time (calculated, 10% to 90%)	5.8 ns				3.5 ns (except 16-bit mode: 5.8 ns)				1.8 ns (except 16-bit mode: 5.8 ns)			
Input connectors	BNCs on front panel											
Resolution* (enhanced vertical resolution)	8, 12, 14, 15 or 16 bits (hardware resolution + 4 bits)											
Input characteristics	1 MΩ ±1% 13 pF, ±1 pF											
Input coupling	AC/DC											
Input sensitivity	2 mV/div to 4 V/div											
Input ranges	±10 mV to ±20 V full scale, in 11 ranges ±250 mV (10, 20, 50, 100, 200 mV ranges) ±2.5 V (500 mV, 1 V, 2 V ranges) ±20 V (5, 10, 20 V ranges)											
Analog offset range												
Analog offset control accuracy	±1% of offset setting, additional to basic DC accuracy											
DC accuracy												
±50 mV to ±20 V	≥ 12-bit mode: ±0.25% typical @ 25°C (±1% of full scale max @ 20 - 30°C) • 8-bit mode: ±1% typical @ 25°C (±3% of full scale max @ 20 - 30°C)											
±10 mV and ±20 mV ranges	All modes: ±2% typical @ 25°C (±5% of full scale max @ 20 - 30°C)											
Overvoltage protection	± 100 V (DC + AC peak)											

* Maximum effective resolution is limited on the lowest voltage ranges: ±10 mV = 8 bits • ±20 mV = 12 bits. All other ranges can use full resolution.

HORIZONTAL						
Max. sampling rate	8-bit mode	12-bit mode	14-bit mode	15-bit mode	16-bit mode	
Any 1 channel	1 GS/s	500 MS/s	125 MS/s	125 MS/s	62.5 MS/s	
Any 2 channels	500 MS/s	250 MS/s	125 MS/s	125 MS/s	-	
Any 3 channels	250 MS/s	125 MS/s	125 MS/s	-	-	
Four channels	250 MS/s	125 MS/s	125 MS/s	-	-	
Maximum ETS rate (8-bit mode only)	2.5 GS/s		5 GS/s		10 GS/s	
Sampling rate (USB streaming)	10 MS/s in PicoScope 6. >10 MS/s using supplied API					
Timebase ranges	2 ns/div to 5000 s/div		1 ns/div to 5000 s/div		500 ps/div to 5000 s/div	
Buffer memory** (8-bit)	16 MS	32 MS	64 MS	128 MS	256 MS	512 MS
Buffer memory** (≥ 12-bit)	8 MS	16 MS	32 MS	64 MS	128 MS	256 MS
Buffer memory** continuous streaming	100 MS in PicoScope software					
Waveform buffer (no. of segments)	10,000 in PicoScope software					
Timebase accuracy (drift)	±50 ppm (±5 ppm/year)		±2 ppm (±1 ppm/year)		±2 ppm (±1 ppm/year)	
Sample jitter	3 ps RMS, typical					
ADC sampling	Simultaneous on all enabled channels					

** Shared between active channels

DYNAMIC PERFORMANCE (typical; analog channels)		
Crosstalk	Better than 400:1 up to full bandwidth (equal voltage ranges)	
Total harmonic distortion (THD)	8-bit mode: < -60 dB at 100 kHz full scale input • ≥ 12-bit mode: < -70 dB at 100 kHz full scale input	
SFDR	8 and 12-bit: > 60 dB at 100 kHz full scale input • 14 to 16-bit: > 70 dB at 100 kHz full scale input	
Noise (on 50 mV range)	8-bit mode 120 μV RMS • 12-bit mode 110 μV RMS • 14-bit mode 100 μV RMS • 15-bit mode 85 μV RMS • 16-bit mode 70 μV RMS	
Bandwidth flatness	(+0.3 dB, -3 dB) from DC to full bandwidth	(+0.3 dB, -3 dB) from DC to full bandwidth

TRIGGERING	PicoScope 5242A/5442A	PicoScope 5242B/5442B	PicoScope 5243A/5443A	PicoScope 5243B/5443B	PicoScope 5244A/5444A	PicoScope 5244B/5444B
Source	All channels					
Trigger modes	None, Auto, Repeat, Single, Rapid (segmented memory)					
Advanced triggers	Edge, Window, Pulse width, Window pulse width, Dropout, Window dropout, Interval, Runt pulse, Logic					
Trigger types (ETS mode)	Rising, falling					
Sensitivity	Digital triggering provides 1 LSB accuracy up to full bandwidth of scope. • ETS mode: Typical 10 mV p-p, at full bandwidth					
Maximum pre-trigger capture	100% of capture size					
Maximum post-trigger capture	4 billion samples					
Trigger re-arm time	< 2 μ s on fastest timebase					
Maximum trigger rate	Up to 10,000 waveforms in a 20 ms burst					

EXTERNAL TRIGGER INPUT

Trigger types	Edge, pulse width, dropout, interval, logic					
Input characteristics	Front panel BNC, 1 M Ω \pm 1% 13 pF \pm 1 pF					
Bandwidth	60 MHz		100 MHz			200 MHz
Voltage range	\pm 5 V, DC coupled					
Overvoltage protection	\pm 100 V (DC + AC peak)					

FUNCTION GENERATOR

Standard output signals	Sine, square, triangle, DC voltage					
Advanced output signals	-	Ramp up/down, sinc, Gaussian, half-sine, white noise, PRBS	-	Ramp up/down, sinc, Gaussian, half-sine, white noise, PRBS	-	Ramp up/down, sinc, Gaussian, half-sine, white noise, PRBS
Standard signal frequency	DC to 20 MHz					
Output frequency accuracy	\pm 50 ppm (\pm 5 ppm/year)		\pm 2 ppm (\pm 1 ppm/year)			\pm 2 ppm (\pm 1 ppm/year)
Output frequency resolution	< 50 mHz					
Output voltage range	\pm 2 V with \pm 1% DC accuracy					
Output voltage adjustment	Signal amplitude and offset adjustable in approx. 0.25 mV steps within overall \pm 2 V range					
Amplitude flatness	< 2 dB to 20 MHz, typical @ 50 Ω load					
SFDR	> 70 dB, 10 kHz full scale sine wave					
Connector type	BNC, 50 Ω output impedance					
Overvoltage protection	\pm 20 V					
Sweep modes	Up, down, or alternating, with selectable start/stop frequencies and increments					

AWG (B models only)

Update rate	-	200 MS/s	-	200 MS/s	-	200 MS/s
Buffer size	-	16 kS	-	32 kS	-	48 kS
Resolution	-	14 bits (output step size approximately 0.25 mV)	-	14 bits (output step size approximately 0.25 mV)	-	14 bits (output step size approximately 0.25 mV)
Bandwidth	-	> 20 MHz	-	> 20 MHz	-	> 20 MHz
Rise time (10% to 90%)	-	< 10 ns	-	< 10 ns	-	< 10 ns

PROBE COMPENSATION OUTPUT

Output characteristics	600 Ω
Output frequency	1 kHz
Output level	3 V pk-pk
Overvoltage protection	10 V

SPECTRUM ANALYZER	PicoScope 5242A/5442A	PicoScope 5242B/5442B	PicoScope 5243A/5443A	PicoScope 5243B/5443B	PicoScope 5244A/5444A	PicoScope 5244B/5444B
Frequency range	DC to 60 MHz		DC to 100 MHz		DC to 200 MHz	
Display modes	Magnitude, average, peak hold					
Windowing functions	Rectangular, Gaussian, triangular, Blackman, Blackman-Harris, Hamming, Hann, flat-top					
Number of FFT points	Selectable from 128 to 1 million in powers of 2					
MATH CHANNELS						
Functions	-x, x+y, x-y, x*y, x/y, x^y, sqrt, exp, ln, log, abs, norm, sign, sin, cos, tan, arcsin, arccos, arctan, sinh, cosh, tanh, delay, average, frequency, derivative, integral, min, max, peak, duty, highpass, lowpass, bandpass, bandstop					
Operands	A, B, C, D (input channels), T (time), reference waveforms, pi					
AUTOMATIC MEASUREMENTS						
Scope mode	AC RMS, true RMS, frequency, cycle time, duty cycle, DC average, falling rate, rising rate, low pulse width, high pulse width, fall time, rise time, minimum, maximum, peak to peak					
Spectrum mode	Frequency at peak, amplitude at peak, average amplitude at peak, total power, THD %, THD dB, THD+N, SFDR, SINAD, SNR, IMD					
Statistics	Minimum, maximum, average, standard deviation					
SERIAL DECODING						
Protocols	1-Wire, ARINC 429, CAN, CAN-FD, DCC, DMX512, Ethernet 10Base-T, Ethernet 100Base-TX, FlexRay, I ² C, I ² S, LIN, PS/2, SENT, SPI, UART (RS-232/RS-422/RS-485), USB					
MASK LIMIT TESTING						
Statistics	Pass/fail, failure count, total count					
DISPLAY						
Interpolation	Linear or sin(x)/x					
Persistence modes	Digital color, analog intensity, custom, fast					
GENERAL						
PC connectivity	USB 2.0 hi-speed (USB 1.1, USB 3.0 and USB 3.1 compatible)					
Power requirements	1 A (2 channels) from 2 USB ports (double-headed cable supplied) or 1.5 A at 5 V (up to 4 channels) from AC adaptor					
Dimensions	190 x 170 x 40 mm (including connectors)					
Weight	< 0.5 kg					
Temperature range	Operating: 0 °C to 40 °C (20 °C to 30 °C for stated accuracy). Storage: -20 °C to 60 °C.					
Humidity range	Operating: 5 %RH to 80 %RH non-condensing. Storage: 5 %RH to 95 %RH non-condensing.					
Environment	Dry locations only; up to 2000 m altitude					
Safety approvals	Designed to EN 61010-1:2010					
EMC approvals	Tested to EN61326-1:2006 and FCC Part 15 Subpart B					
Environmental approvals	RoHS and WEEE compliant					
Software/PC requirements	PicoScope 6: Microsoft Windows 7, 8 or 10 SDK and example programs: Microsoft Windows 7, 8 or 10					
Accessories	USB cable(s), 2 or 4 probes in probe case, AC adaptor for 4-channel scope					
Languages	Simplified Chinese, Czech, Danish, Dutch, English, Finnish, French, German, Greek, Hungarian, Italian, Japanese, Korean, Norwegian, Polish, Portuguese, Romanian, Russian, Spanish, Swedish, Turkish					

Connections

The front panels of the 2-channel PicoScope 5000 Series oscilloscopes have:

- 2 x BNC analog input channels
- 1 x BNC external trigger input
- 1 x BNC AWG/function generator output
- 1 x probe compensation output

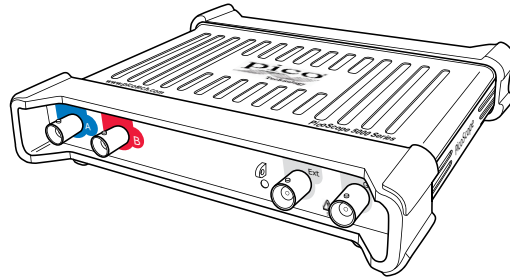

The front panels of the 4-channel PicoScope 5000 Series oscilloscopes have:

- 4 x BNC analog input channels
- 1 x BNC external trigger input
- 1 x BNC AWG/function generator output
- 1 x probe compensation output

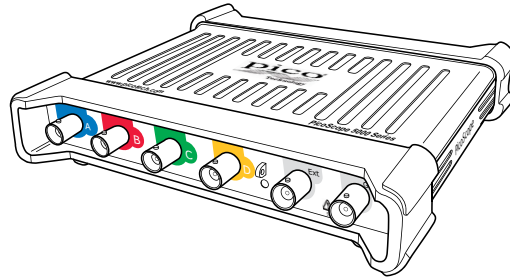

The rear panels of all oscilloscopes in the PicoScope 5000 Series have:

- 1 x DC power socket
- 1 x USB 2.0 port

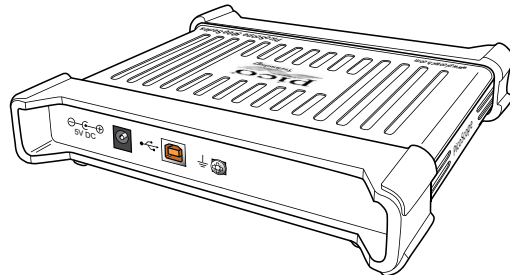

Kit contents and accessories

Your PicoScope 5000 Series oscilloscope kit contains the following items:

- PicoScope 5000 Series oscilloscope
- 2 x probes (2-channel scopes)
- 4 x probes (4-channel scopes)
- Double-headed USB 2.0 cable
- Standard USB 2.0 cable (4-channel scopes only)
- DC power supply (4-channel scopes only)
- Quick Start Guide
- Software and Reference CD

Probes

Your PicoScope 5000 Series oscilloscope kit comes with probes specifically trimmed to match the performance of your oscilloscope. The part numbers for these probes are as follows:



60 MHz	150 MHz	250 MHz
MI007	TA132	TA131

Ordering information

ORDER CODE	DESCRIPTION	NUMBER OF CHANNELS	BANDWIDTH	OUTPUT	BUFFER SIZE	PROBES SUPPLIED	USD*	EUR*	GBP*
PP863	PicoScope 5242A	2	60 MHz	Function generator	16 MS	2 x 60 MHz	1155	979	799
PP864	PicoScope 5242B			AWG	32 MS		1315	1115	909
PP865	PicoScope 5243A	2	100 MHz	Function generator	64 MS	2 x 150 MHz	1485	1255	1035
PP866	PicoScope 5243B			AWG	128 MS		1645	1395	1135
PP867	PicoScope 5244A	2	200 MHz	Function generator	256 MS	2 x 250 MHz	1805	1535	1245
PP868	PicoScope 5244B			AWG	512 MS		1975	1675	1365
PP869	PicoScope 5442A	4	60 MHz	Function generator	16 MS	4 x 60 MHz	1565	1325	1085
PP870	PicoScope 5442B			AWG	32 MS		1805	1535	1245
PP871	PicoScope 5443A	4	100 MHz	Function generator	64 MS	4 x 150 MHz	2055	1745	1415
PP872	PicoScope 5443B			AWG	128 MS		2305	1955	1595
PP873	PicoScope 5444A	4	200 MHz	Function generator	256 MS	4 x 250 MHz	2545	2165	1765
PP874	PicoScope 5444B			AWG	512 MS		2795	2375	1925

UK global headquarters:

Pico Technology
James House
Colmworth Business Park
St. Neots
Cambridgeshire
PE19 8YP
United Kingdom

☎ +44 (0) 1480 396 395
☎ +44 (0) 1480 396 296
✉ sales@picotech.com

North America regional office:

Pico Technology
320 N Glenwood Blvd
Tyler
Texas 75702
United States

☎ +1 800 591 2796
☎ +1 620 272 0981
✉ sales@picotech.com

Asia-Pacific regional office:

Pico Technology
Room 2252, 22/F, Centro
568 Hengfeng Road
Zhabei District
Shanghai 200070
PR China

☎ +86 21 2226-5152
✉ pico.china@picotech.com

* Prices correct at the time of publication. Sales taxes not included. Please check www.picotech.com for the latest prices before ordering.

Errors and omissions excepted. *Pico Technology* and *PicoScope* are internationally registered trade marks of Pico Technology Ltd.

MM040.en-10. Copyright © 2013–2017 Pico Technology Ltd. All rights reserved.



www.picotech.com