

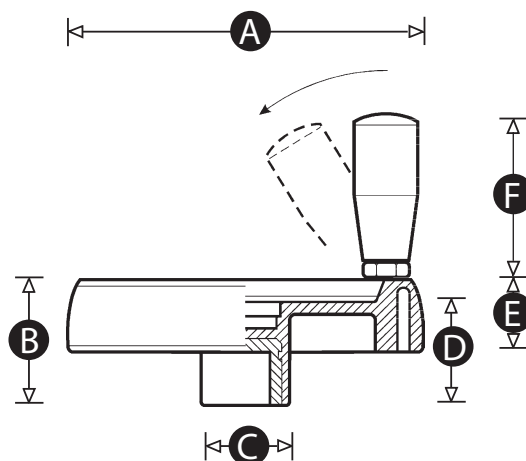

Datasheet

ENGLISH

Solid Control Handwheel with Flush Folding Handle



Material

High impact resistant thermoplastic

Standard Colour

Black

Finish

Matt

Insert Material

Zinc plated steel

Handle

Revolving folding handle. Recessed area to allow handle to be folded flush to the wheel.

Part No.	A	B	C	D	E	F	Pilot bore (mm)	Maximum bore (mm)
7027857	80	35	25	31	18	38	8	20
7027866	100	44	30	37	24	48	8	20
7027847	124	50	36	40	27	58	8	20
7027841	150	53	38	43	32	60	8	22
7027850	175	57	40	47	35	70	8	28
7027853	200	60	44	50	38	80	8	28