

MARKING:

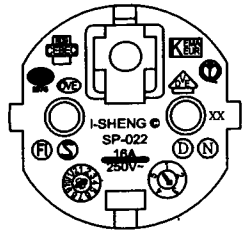

MARKING:

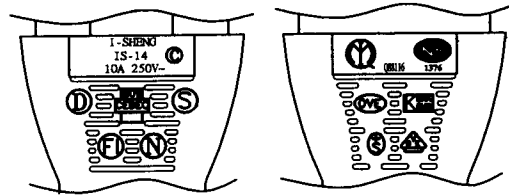

| No | BOM ITEM | Q' TY | P/N |
|----|------------------------|-------|----------|
| 1 | SP-023 INSERT(BLACK) | 1 pcs | MB023012 |
| 2 | PVC 45P (SA87, SP-022) | 33 g | RPP04512 |
| 3 | KPR-14 TERMINAL | 3 pcs | BBB14000 |
| 4 | IS-14 INNER BODY | 1 set | MI014000 |
| 5 | PVC 45P (SA87, IS-14) | 22 g | RPP04512 |
| 6 | PE TIE (BLACK, 8 inch) | 1 pcs | KBB10008 |
| 7 | PE BAG | 1 pcs | KPR11000 |
| 8 | LABLE | 1 pcs | |

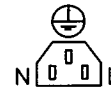
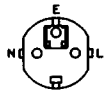

NOTE : 1. CORD : EAN-128C
2 : SCAN CONTENT : 6266694

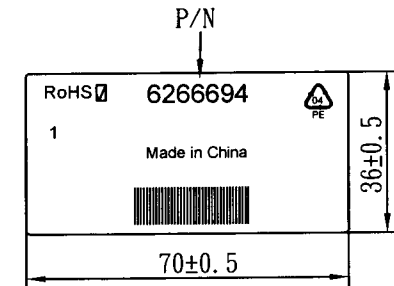
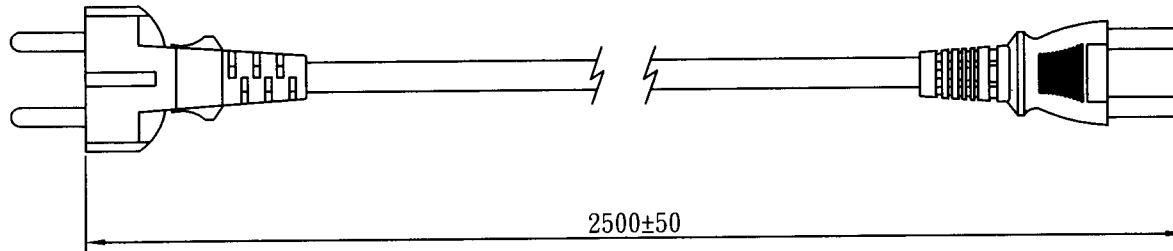

WIRING COLOR:

E: Yellow/Green
N: Blue
L: Brown

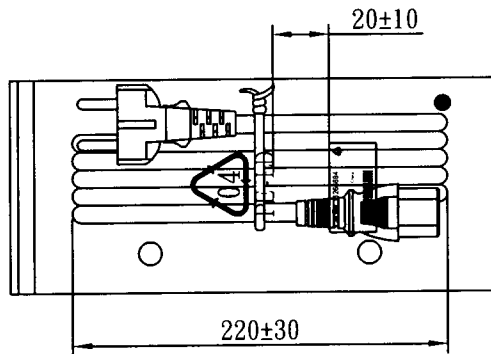

LENGTH ON CORD: (205-14)

I-SHENG SGIS <VDE> KEMA-KEUR <VDE> △CEBEC 809
NF-USE 1346 IEMMEQU H05VV-F 3G 1.0mm² 60227 IEC 53 RVV 300/500V
A003083 3ASL/100 4V-75 V-75(75°C) 250/440V ORDINARY DUTY Q90033 -LF- CE

| | | | | |
|----------------------|---|--------------------|--------------|--------------------|
| CABLE | H05VV-F 3G 1.0 DENT PRINT CT-12 (BLACK) | | | |
| PLUG | SP-022 + IS-14 | LENGTH | 2500 | UNIT mm |
| CLIENT | NAME | First Connectivity | N/W | 0.255323 UNIT kg |
| | P/N | 6266694 | SG DWG | SR-142461-4 VER. A |
| | | | Design. by | 陽建春 9/26/16 |
| | | | Review. by | |
| | | | Approval. by | 王... 9/26/16 |
| V24 6C3016 12 250 01 | | | | |