

# Panel Meters with Advanced Signal Processing Capabilities K3HB

K3HB-X/Process Indicator

K3HB-V/Weighing Indicator

K3HB-H/Temperature Indicator

K3HB-S/Linear Sensor Indicator



## Features

### Red-Green Display Allows Easy Recognition of Judgement Results

- The measurement value display can be set to switch between red and green in accordance with the status of comparative outputs. This means that the status can be ascertained at a distance.

### Position Meter Enables Easy Monitoring of Operating Status Trends

- The present value with respect to the measurement or display range (full scale) can be viewed on a bar display. The operating status can be grasped intuitively, allowing easy judgement of levels and threshold values.

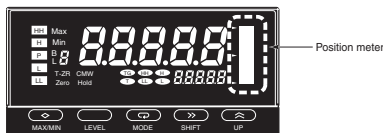

### Many Measurement and Discrimination Functions Using External Event Input

- Offers a wide variety of application possibilities, such as detection and judgement while synchronizing on an external signal.

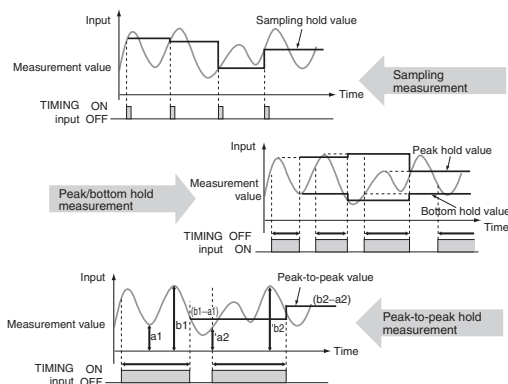

### High-speed Sampling at 50 Times per Second (20 ms)

- Provides an input sampling cycle at least three times faster than earlier models (12.5 times faster for temperature input models) at 50 times/second (see note). In addition to improved response times for judgement output and transfer output, average processing can be used to increase the stability of measurements.

**Note:** The K3HB-S Linear Sensor Indicator features high-speed response of 2,000 times/second.

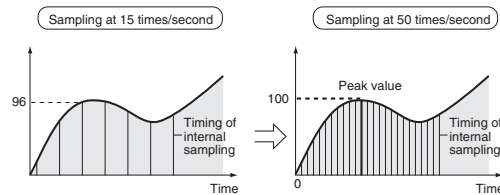

### Short Body with Depth of Only 95 mm (from Behind the Front Panel)

- A short body of only 95 mm (see note) contributes to the development of slimmer and smaller control panels and installations.

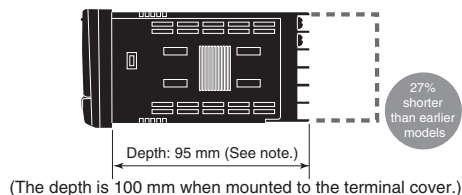

**Note:** Depth of DeviceNet models is 97 mm.

## Select a Comparative Output Pattern to Suit the Discrimination or Control Application

- The output pattern for comparative outputs can be selected. In addition to high/low comparison with set values, output based on level changes is also possible. (Use the type of output pattern appropriate for the application.)

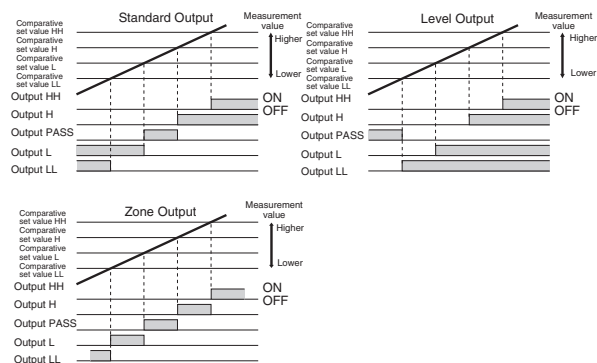

**Note:** The HH, H, L, or LL outputs must be set in that order for the zone outputs to output correctly. (This is because the comparative set values and outputs for standard and level outputs are in a 1-to-1 relationship, whereas the meaning of zone outputs depends on the settings of all the comparative set values.)

## DeviceNet Models Enable High-speed Data Communications with PLCs without Special Programming

- DeviceNet compliance enables high-speed data transmission of discrimination results and hold values by allocating setting and monitoring parameters in the I/O memory of the PLC. This capability greatly reduces labor spent in developing communications programs.

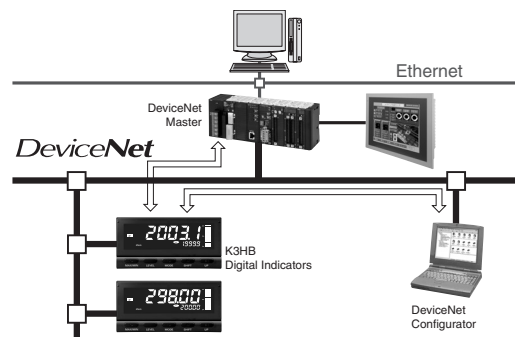

# K3HB-series Product Lineup

## ■ K3HB-X Process Indicator (page B-11)

Indicates Measurements for Voltage/Current Signals



- DC Voltage Input Type: K3HB-XVD  
( $\pm 199.99$  V,  $\pm 19.999$  V,  $\pm 1.9999$  V, 1.0000 to 5.0000 V)
- DC Current Input Type: K3HB-XAD  
( $\pm 199.99$  mA,  $\pm 19.999$  mA,  $\pm 1.9999$  mA, 4.000 to 20.000 mA)
- AC Voltage Input Type: K3HB-XVA  
(0.0 to 400.0 V, 0.00 to 199.99 V, 0.0000 to 1.9999 V)
- AC Current Input Type: K3HB-XAA  
(0.000 to 10.000 A, 0.0000 to 1.9999 A, 0.00 to 199.99 mA, 0.000 to 19.999 mA)

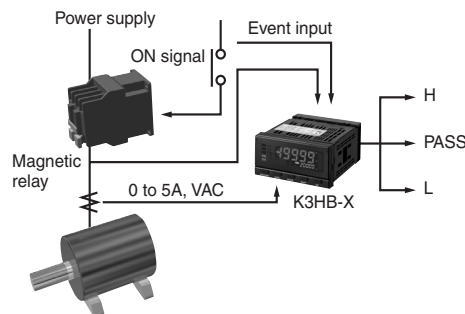

## ■ K3HB-V Weighing Indicator (page B-16)

Indicates Weight Measurements Using a Load Cell



- K3HB-VLC  
(0.00 to 199.99 mV, 0.000 to 19.999 mV,  $\pm 100.00$  mV,  $\pm 199.99$  mV)

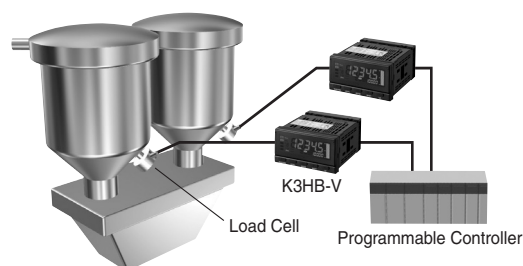

## ■ K3HB-H Temperature Indicator (page B-21)

Indicates Temperature and Various Process Measurements



- K3HB-HTA  
Platinum-resistance thermometer (Pt100: 2 ranges)  
Thermocouple (K: 2 ranges, J: 2 ranges, T, E, L, U, N, R, S, B, W)

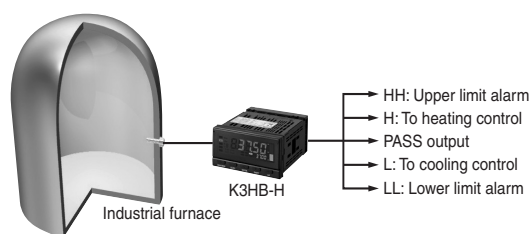

## ■ K3HB-S Linear Sensor Indicator (page B-26)

Measures and Discriminates Results From Two Analog Inputs at High Speed with High Accuracy



- K3HB-SSD  
0.000 to 20.000 mA, 4.000 to 20.000 mA, 0.000 to 5.000 V, 1.000 to 5.000 V,  $\pm 5.000$  V,  $\pm 10.000$  V, two-channel input

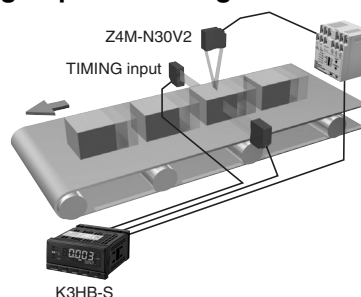

# K3HB-X Process Indicator

## A Process Indicator Ideal for Discriminating and Displaying Measurements for Voltage/Current Signals

- Easy recognition of judgement results using color display that can be switched between red and green.
- Equipped with a position meter for monitoring operating status trends.
- External event input allows use in various measurement and discrimination applications.
- Series expanded to include DeviceNet models.
- Short body with depth of only 95 mm (from behind the front panel), or 97 mm for DeviceNet models.
- UL certification approval (Certification Mark License) pending.
- CE Marking conformance by third party assessment body.
- Water-resistant enclosure conforms to NEMA 4X (equivalent to IP66).
- Capable of high-speed sampling at 50 times per second (20 ms)
- Easy-to-set two-point scaling allows conversion and display of any user-set values.



## Model Number Structure

### Model Number Legend

Base Units and Optional Boards can be ordered individually.

#### Base Units

K3HB-X    
1 2

##### 1. Input Sensor Codes

VD: DC voltage input  
AD: DC current input  
VA: AC voltage input  
AA: AC current input

##### 2. Supply Voltage

100240VAC: 100 to 240 VAC  
24VACVDC: 24 VAC/VDC

#### Optional Boards

##### Sensor Power Supply/Output Boards

K33-  
3

##### 3. Sensor Power Supply/Output Type Codes

None: None  
CPA: Relay output (PASS: SPDT) + Sensor power supply (12 VDC +/-10%, 80 mA) (See note 1.)  
CPB: Relay output (PASS: SPDT) + Sensor power supply (10 VDC +/-5%, 100 mA) (See note 1.)  
L1A: Linear current output (DC0(4) - 20 mA) + Sensor power supply (12 VDC +/-10%, 80 mA) (See note 2.)  
L1B: Linear current output (DC0(4) - 20 mA) + Sensor power supply (10 VDC +/-5%, 100 mA) (See note 2.)  
L2A: Linear voltage output (DC0(1) - 5 V, 0 to 10 V) + Sensor power supply (12 VDC +/-10%, 80 mA) (See note 2.)  
L2B: Linear voltage output (DC0(1) - 5 V, 0 to 10 V) + Sensor power supply (10 VDC +/-5%, 100 mA) (See note 2.)  
A: Sensor power supply (12 VDC +/-10%, 80 mA)  
B: Sensor power supply (10 VDC +/-5%, 100 mA)  
FLK1A: Communications (RS-232C) + Sensor power supply (12 VDC +/-10%, 80 mA) (See note 2.)  
FLK1B: Communications (RS-232C) + Sensor power supply (10 VDC +/-5%, 100 mA) (See note 2.)  
FLK3A: Communications (RS-485) + Sensor power supply (12 VDC +/-10%, 80 mA) (See note 2.)  
FLK3B: Communications (RS-485) + Sensor power supply (10 VDC +/-5%, 100 mA) (See note 2.)

**Note:** 1. CPA and CPB can be combined with relay outputs only.

2. Only one of communications, BCD, or DeviceNet can be used by each Digital indicator.

## Relay/Transistor Output Boards

K34-□  
4

### 4. Relay/Transistor Output Type Codes

- None: None
- C1: Relay contact (H/L: SPDT each)
- C2: Relay contact (HH/H/LL/L: SPST-NO each)
- T1: Transistor (NPN open collector: HH/H/PASS/L/LL)
- T2: Transistor (PNP open collector: HH/H/PASS/L/LL)
- DRT: DeviceNet (See note 2.)

**Note:** 1. CPA and CPB can be combined with relay outputs only.

2. Only one of communications, BCD, or DeviceNet can be used by each Digital indicator.

## Event Input Boards

K35-□  
5

### 5. Event input Type Codes

- None: None
- 1: 5 points (M3 terminal blocks) NPN open collector
- 2: 8 points (10-pin MIL connector) NPN open collector
- 3: 5 points (M3 terminal blocks) PNP open collector
- 4: 8 points (10-pin MIL connector) PNP open collector

## ■ Accessories (Sold Separately)

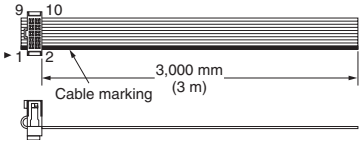
Name	Appearance	Wiring	Model																						
Special Cable (for event inputs with 8-pin connector)		<table border="1"> <thead> <tr> <th>Pin No.</th> <th>Signal name</th> </tr> </thead> <tbody> <tr><td>1</td><td>TIMING</td></tr> <tr><td>2</td><td>S-TMR</td></tr> <tr><td>3</td><td>HOLD</td></tr> <tr><td>4</td><td>RESET</td></tr> <tr><td>5</td><td>ZERO</td></tr> <tr><td>6</td><td>COM</td></tr> <tr><td>7</td><td>BANK4</td></tr> <tr><td>8</td><td>BANK2</td></tr> <tr><td>9</td><td>BANK1</td></tr> <tr><td>10</td><td>COM</td></tr> </tbody> </table>	Pin No.	Signal name	1	TIMING	2	S-TMR	3	HOLD	4	RESET	5	ZERO	6	COM	7	BANK4	8	BANK2	9	BANK1	10	COM	K32-DICN
Pin No.	Signal name																								
1	TIMING																								
2	S-TMR																								
3	HOLD																								
4	RESET																								
5	ZERO																								
6	COM																								
7	BANK4																								
8	BANK2																								
9	BANK1																								
10	COM																								

# Specifications

## ■ Ratings

<b>Power supply voltage</b>	100 to 240 VAC (50/60 Hz), 24 VAC/VDC, DeviceNet power supply: 24 VDC	
<b>Allowable power supply voltage range</b>	85% to 110% of the rated power supply voltage, DeviceNet power supply: 11 to 25 VDC	
<b>Power consumption (See note 1.)</b>	100 to 240 V: 18 VA max. (max. load) 24 VAC/DC: 11 VA/7 W max. (max. load)	
<b>Current consumption</b>	DeviceNet power supply: 50 mA max. (24 VDC)	
<b>Input</b>	DC voltage, DC current, AC voltage, AC current	
<b>A/D conversion method</b>	Delta-Sigma method	
<b>External power supply</b>	See Sensor Power Supply/Output Type Codes	
<b>Event inputs (See note 2.)</b>	<b>Timing input</b>	NPN open collector or no-voltage contact signal
	<b>Startup compensation timer input</b>	ON residual voltage: 3 V max. ON current at 0 Ω: 17 mA max. Max. applied voltage: 30 VDC max. OFF leakage current: 1.5 mA max.
	<b>Hold input</b>	NPN open collector or no-voltage contact signal
	<b>Reset input</b>	ON residual voltage: 2 V max. ON current at 0 Ω: 4 mA max.
	<b>Forced-zero input</b>	Max. applied voltage: 30 VDC max.
	<b>Bank input</b>	OFF leakage current: 0.1 mA max.
<b>Output ratings (depends on the model)</b>	<b>Relay output</b>	250 VAC, 30 VDC, 5 A (resistive load) Mechanical life expectancy: 5,000,000 operations, Electrical life expectancy: 100,000 operations
	<b>Transistor output</b>	Maximum load voltage: 24 VDC, Maximum load current: 50 mA, Leakage current: 100 μA max.
	<b>Linear output</b>	Linear output 0 to 20 mA DC, 4 to 20 mA: Load: 500 Ω max, Resolution: Approx. 10,000, Output error: ±0.5% FS Linear output 0 to 5 VDC, 1 to 5 VDC, 0 to 10 VDC: Load: 5 kΩ max, Resolution: Approx. 10,000, Output error: ±0.5% FS (1 V or less: ±0.15 V; not output for 0 V or less)
<b>Display method</b>	Negative LCD (backlit LED) display 7-segment digital display (Character height: PV: 14.2 mm (green/red); SV: 4.9 mm (green))	
<b>Main functions</b>	Scaling function, measurement operation selection, averaging, previous average value comparison, forced-zero, zero-limit, output hysteresis, output OFF delay, output test, teaching, display value selection, display color selection, key protection, bank selection, display refresh period, maximum/minimum hold, reset	
<b>Ambient operating temperature</b>	-10 to 55°C (with no icing or condensation)	
<b>Ambient operating humidity</b>	25% to 85%	
<b>Storage temperature</b>	-25 to 65°C (with no icing or condensation)	
<b>Altitude</b>	2,000 m max.	
<b>Accessories</b>	Watertight packing, 2 fixtures, terminal cover, unit stickers, instruction manual. DeviceNet models also include a DeviceNet connector (Hirose HR31-5.08P-5SC(01)) and crimp terminals (Hirose HR31-SC-121) (See note 3.)	

**Note: 1.** DC power supply models require a control power supply capacity of approximately 1 A per Unit when power is turned ON. Particular attention is required when using two or more DC power supply models. The OMRON S8VS-series DC Power Supply Unit is recommended.

**2.** PNP input types are also available.

**3.** For K3HB-series DeviceNet models, use only the DeviceNet Connector included with the product. The crimp terminals provided are for Thin Cables.

## ■ Characteristics

<b>Display range</b>	-19,999 to 99,999	
<b>Sampling period</b>	20 ms (50 times/second)	
<b>Comparative output response time</b>	DC input: 100 ms max.; AC input: 300 ms max.	
<b>Linear output response time</b>	DC input: 150 ms max.; AC input: 420 ms max.	
<b>Insulation resistance</b>	20 MΩ min. (at 500 VDC)	
<b>Dielectric strength</b>	2,300 VAC for 1 min between external terminals and case	
<b>Noise immunity</b>	100 to 240 VAC models: ±1,500 V at power supply terminals in normal or common mode (waveform with 1-ns rising edge and pulse width of 1 μs/100 ns) 24 VAC/VDC models: ±1,500 V at power supply terminals in normal or common mode (waveform with 1-ns rising edge and pulse width of 1 μs/100 ns)	
<b>Vibration resistance</b>	Frequency: 10 to 55 Hz; Acceleration: 50 m/s <sup>2</sup> , 10 sweeps of 5 min each in X, Y, and Z directions	
<b>Shock resistance</b>	150 m/s <sup>2</sup> (100 m/s <sup>2</sup> for relay outputs) 3 times each in 3 axes, 6 directions	
<b>Weight</b>	Approx. 300 g (Digital Indicator only)	
<b>Degree of protection</b>	<b>Front panel</b>	Conforms to NEMA 4X for indoor use (equivalent to IP66)
	<b>Rear case</b>	IP20
	<b>Terminals</b>	IP00 + finger protection (VDE0106/100)
<b>Memory protection</b>	EEPROM (non-volatile memory) Number of rewrites: 100,000	
<b>Applicable standards</b>	UL61010C-1, CSA C22.2 No. 1010.1 (approval pending) EN61010-1 (IEC61010-1): Pollution degree 2/Overvoltage category II EN61326: 1997, A1: 1998, A2: 2001	
<b>EMC</b>	EMI: EN61326+A1 industrial applications Electromagnetic radiation interference CISPR 11 Group 1, Class A: CISPRL16-1/-2 Terminal interference voltage CISPR 11 Group 1, Class A: CISPRL16-1/-2 EMS: EN61326+A1 industrial applications Electrostatic Discharge Immunity EN61000-4-2: 4 kV (contact), 8 kV (in air) Radiated Electromagnetic Field Immunity EN61000-4-3: 10 V/m 1 kHz sine wave amplitude modulation (80 MHz to 1 GHz) Electrical Fast Transient/Burst Immunity EN61000-4-4: 2 kV (power line), 1 kV (I/O signal line) Surge Immunity EN61000-4-5: 1 kV with line (power line), 2 kV with ground (power line) Conducted Disturbance Immunity EN61000-4-6: 3 V (0.15 to 80 MHz) Voltage Dips and Interruptions Immunity EN61000-4-11: 0.5 cycle, 0°/180°, 100% (rated voltage)	

## ■ Input Range (Measurement Range and Accuracy) CAT II

Input type	Range	Set value	Measurement range	Input impedance	Accuracy (See Note 1 & 2)	Allowable instantaneous overload (30 s)
K3HB-XVD DC voltage	A	$R \ \omega d$	$\pm 199.99 \text{ V}$	10 M $\Omega$ min.	$\pm 0.1\% \text{rdg} \pm 1 \text{ digit}$ max.	$\pm 400 \text{ V}$
	B	$b \ \omega d$	$\pm 19.999 \text{ V}$	1 M $\Omega$ min.		$\pm 200 \text{ V}$
	C	$C \ \omega d$	$\pm 1.9999 \text{ V}$			
	D	$d \ \omega d$	1.0000 to 5.0000 V			
K3HB-XAD DC current	A	$R \ R d$	$\pm 199.99 \text{ mA}$	1 $\Omega$ max.	$\pm 0.1\% \text{rdg} \pm 1 \text{ digit}$ max.	$\pm 400 \text{ mA}$
	B	$b \ R d$	$\pm 19.999 \text{ mA}$	10 $\Omega$ max.		$\pm 200 \text{ mA}$
	C	$C \ R d$	$\pm 1.9999 \text{ mA}$	33 $\Omega$ max.		
	D	$d \ R d$	4.000 to 20.000 mA	10 $\Omega$ max.		
K3HB-XVA AC voltage	A	$R \ \omega R$	0.0 to 400.0 V	1 M $\Omega$ min.	$\pm 0.3\% \text{rdg} \pm 5 \text{ dig-}$ its max.	700 V
	B	$b \ \omega R$	0.00 to 199.99 V			400 V
	C	$C \ \omega R$	0.000 to 19.999 V		$\pm 0.5\% \text{rdg} \pm 10$ digits max.	
	D	$d \ \omega R$	0.0000 to 1.9999 V			
K3HB-XAA AC current	A	$R \ R R$	0.000 to 10.000 A	(0.5 VA CT) (See note 3.)	$\pm 0.5\% \text{rdg} \pm 20$ digits max.	20 A
	B	$b \ R R$	0.0000 to 1.9999 A	(0.5 VA CT) (See note 3.)		
	C	$C \ R R$	0.00 to 199.99 mA	1 $\Omega$ max.	$\pm 0.5\% \text{rdg} \pm 10$ digits max.	2 A
	D	$d \ R R$	0.000 to 19.999 mA	10 $\Omega$ max.		

**Note: 1.** The accuracy is for an input frequency range of 40 Hz to 1 kHz (except for AD current input A and B ranges) and an ambient temperature of 23  $\pm$ 5°C. The error, however, increases below 10% of the maximum input value.

DC voltage input (all ranges): 10% or less of max. input =  $\pm 0.15\%$  FS

DC current input (all ranges): 10% or less of max. input =  $\pm 0.1\%$  FS

AC voltage input (A: 0.0 to 400.0 V): 10% or less of max. input =  $\pm 0.15\%$  FS

AC voltage input (B: 0.00 to 199.99 V): 10% or less of max. input =  $\pm 0.2\%$  FS

AC voltage input (C: 0.000 to 19.999 V; D: 0.0000 to 1.9999 V): 10% or less of max. input =  $\pm 1.0\%$  FS

AC current input (A: 0.000 to 10.000 A): 10% or less of max. input =  $\pm 0.25\%$  FS

AC current input (B: 0.0000 to 1.9999 A): 10% or less of max. input =  $\pm 0.5\%$  FS

AC current input, (C: 0.00 to 199.99 mA; D: 0.000 to 19.999 A): 10% or less of max. input =  $\pm 0.15\%$  FS

When DC voltage input models are used with a  $\pm 1.9999 \text{ V}$  range, make sure that the connections between input terminals are not open. If the input terminals are open, the display will show large variations. Connect resistance of approximately 1 M $\Omega$  between the input terminals if they are open.

2. The letters "rdg" mean "reading" and refer to the input error.

3. The value (0.5 VA CT) is the VA consumption of the internal CT (current transformer).

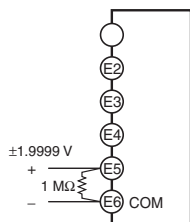



# K3HB-V Weighing Indicator

**An Ideal Indicator for OK/NG Judgements in Automated Filling and Packing Machines, Measuring Factors such as Pressure, Load, Torque, and Weight Using Load Cell Signal Input.**

- Easy recognition of judgement results using color display that can be switched between red and green.
- Equipped with a position meter for monitoring operating status trends.
- External event input allows use in various measurement and discrimination applications.
- Series expanded to include DeviceNet models.
- Short body with depth of only 95 mm (from behind the front panel), or 97 mm for DeviceNet models.
- UL certification approval (Certification Mark License).
- CE Marking conformance by third party assessment body.
- Water-resistant enclosure conforms to NEMA 4X (equivalent to IP66).
- Capable of high-speed sampling at 50 times per second (20 ms)
- Easy-to-set two-point scaling allows conversion and display of any user-set values.



## Model Number Structure

### Model Number Legend

Base Units and Optional Boards can be ordered individually.

#### Base Units

K3HB-V    
1 2

##### 1. Input Sensor Codes

LC: Load cell input (DC low-voltage input)

##### 2. Supply Voltage

100240VAC: 100 to 240 VAC

24VACVDC: 24 VAC/VDC

#### Optional Boards

##### Sensor Power Supply/Output Boards

K33-  
3

##### 3. Sensor Power Supply/Output Type Codes

- None: None
- CPA: Relay output (PASS: SPDT) + Sensor power supply (12 VDC +/-10%, 80 mA) (See note 1.)
- CPB: Relay output (PASS: SPDT) + Sensor power supply (10 VDC +/-5%, 100 mA) (See note 1.)
- L1A: Linear current output (DC0(4) - 20 mA) + Sensor power supply (12 VDC +/-10%, 80 mA) (See note 2.)
- L1B: Linear current output (DC0(4) - 20 mA) + Sensor power supply (10 VDC +/-5%, 100 mA) (See note 2.)
- L2A: Linear voltage output (DC0(1) - 5 V, 0 to 10 V) + Sensor power supply (12 VDC +/-10%, 80 mA) (See note 2.)
- L2B: Linear voltage output (DC0(1) - 5 V, 0 to 10 V) + Sensor power supply (10 VDC +/-5%, 100 mA) (See note 2.)
- A: Sensor power supply (12 VDC +/-10%, 80 mA)
- B: Sensor power supply (10 VDC +/-5%, 100 mA)
- FLK1A: Communications (RS-232C) + Sensor power supply (12 VDC +/-10%, 80 mA) (See note 2.)
- FLK1B: Communications (RS-232C) + Sensor power supply (10 VDC +/-5%, 100 mA) (See note 2.)
- FLK3A: Communications (RS-485) + Sensor power supply (12 VDC +/-10%, 80 mA) (See note 2.)
- FLK3B: Communications (RS-485) + Sensor power supply (10 VDC +/-5%, 100 mA) (See note 2.)

- Note:**
1. CPA and CPB can be combined with relay outputs only.
  2. Only one of communications, BCD, or DeviceNet can be used by each Digital indicator.

**Relay/Transistor Output Boards**

**K34-**   
4

**4. Relay/Transistor Output Type Codes**

- None: None
- C1: Relay contact (H/L: SPDT each)
- C2: Relay contact (HH/H/LL/L: SPST-NO each)
- T1: Transistor (NPN open collector: HH/H/PASS/L/LL)
- T2: Transistor (PNP open collector: HH/H/PASS/L/LL)
- DRT: DeviceNet (See note 2.)

**Note:** 1. CPA and CPB can be combined with relay outputs only.  
 2. Only one of communications, BCD, or DeviceNet can be used by each Digital indicator.

**Event Input Boards**

**K35-**   
5

**5. Event input Type Codes**

- None: None
- 1: 5 points (M3 terminal blocks) NPN open collector
- 2: 8 points (10-pin MIL connector) NPN open collector
- 3: 5 points (M3 terminal blocks) PNP open collector
- 4: 8 points (10-pin MIL connector) PNP open collector

**■ Accessories (Sold Separately)**

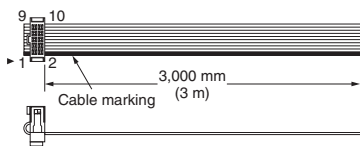
Name	Appearance	Wiring	Model																						
Special Cable (for event inputs with 8-pin connector)		<table border="1" style="margin-left: auto; margin-right: auto; border-collapse: collapse;"> <thead> <tr> <th style="width: 10%;">Pin No.</th> <th style="width: 50%;">Signal name</th> </tr> </thead> <tbody> <tr><td>1</td><td>TIMING</td></tr> <tr><td>2</td><td>S-TMR</td></tr> <tr><td>3</td><td>HOLD</td></tr> <tr><td>4</td><td>RESET</td></tr> <tr><td>5</td><td>ZERO</td></tr> <tr><td>6</td><td>COM</td></tr> <tr><td>7</td><td>BANK4</td></tr> <tr><td>8</td><td>BANK2</td></tr> <tr><td>9</td><td>BANK1</td></tr> <tr><td>10</td><td>COM</td></tr> </tbody> </table>	Pin No.	Signal name	1	TIMING	2	S-TMR	3	HOLD	4	RESET	5	ZERO	6	COM	7	BANK4	8	BANK2	9	BANK1	10	COM	K32-DICN
Pin No.	Signal name																								
1	TIMING																								
2	S-TMR																								
3	HOLD																								
4	RESET																								
5	ZERO																								
6	COM																								
7	BANK4																								
8	BANK2																								
9	BANK1																								
10	COM																								

# Specifications

## ■ Ratings

<b>Power supply voltage</b>		100 to 240 VAC (50/60 Hz), 24 VAC/VDC, DeviceNet power supply: 24 VDC
<b>Allowable power supply voltage range</b>		85% to 110% of the rated power supply voltage, DeviceNet power supply: 11 to 25 VDC
<b>Power consumption (See note 1.)</b>		100 to 240 V: 18 VA max. (max. load) 24 VAC/DC: 11 VA/7 W max. (max. load)
<b>Current consumption</b>		DeviceNet power supply: 50 mA max. (24 VDC)
<b>Input</b>		DC voltage
<b>A/D conversion method</b>		Delta-Sigma method
<b>External power supply</b>		See Sensor Power Supply/Output Type Codes
<b>Event inputs (See note 2.)</b>	<b>Timing input</b>	NPN open collector or no-voltage contact signal ON residual voltage: 3 V max.
	<b>Startup compensation timer input</b>	ON current at 0 Ω: 17 mA max. Max. applied voltage: 30 VDC max. OFF leakage current: 1.5 mA max.
	<b>Hold input</b>	NPN open collector or no-voltage contact signal
	<b>Reset input</b>	ON residual voltage: 2 V max. ON current at 0 Ω: 4 mA max.
	<b>Forced-zero input</b>	Max. applied voltage: 30 VDC max.
	<b>Bank input</b>	OFF leakage current: 0.1 mA max.
<b>Output ratings (depends on the model)</b>	<b>Relay output</b>	250 VAC, 30 VDC, 5 A (resistive load) Mechanical life expectancy: 5,000,000 operations, Electrical life expectancy: 100,000 operations
	<b>Transistor output</b>	Maximum load voltage: 24 VDC, Maximum load current: 50 mA, Leakage current: 100 μA max.
	<b>Linear output</b>	Linear output 0 to 20 mA DC, 4 to 20 mA: Load: 500 Ω max, Resolution: Approx. 10,000, Output error: ±0.5% FS Linear output 0 to 5 VDC, 1 to 5 VDC, 0 to 10 VDC: Load: 5 kΩ max, Resolution: Approx. 10,000, Output error: ±0.5% FS (1 V or less: ±0.15 V; not output for 0 V or less)
<b>Display method</b>		Negative LCD (backlit LED) display 7-segment digital display (Character height: PV: 14.2 mm (green/red); SV: 4.9 mm (green))
<b>Main functions</b>		Scaling function, measurement operation selection, averaging, previous average value comparison, forced-zero, zero-limit, output hysteresis, output OFF delay, output test, teaching, display value selection, display color selection, key protection, bank selection, display refresh period, maximum/minimum hold, reset
<b>Ambient operating temperature</b>		-10 to 55°C (with no icing or condensation)
<b>Ambient operating humidity</b>		25% to 85%
<b>Storage temperature</b>		-25 to 65°C (with no icing or condensation)
<b>Altitude</b>		2,000 m max.
<b>Accessories</b>		Watertight packing, 2 fixtures, terminal cover, unit stickers, operation manual. DeviceNet models also include a DeviceNet connector (Hirose HR31-5.08P-5SC(01)) and crimp terminals (Hirose HR31-SC-121) (See note 3.)

- Note:**
1. DC power supply models require a control power supply capacity of approximately 1 A per Unit when power is turned ON. Particular attention is required when using two or more DC power supply models. The OMRON S8VS-series DC Power Supply Unit is recommended.
  2. PNP input types are also available.
  3. For K3HB-series DeviceNet models, use only the DeviceNet Connector included with the product. The crimp terminals provided are for Thin Cables.

## ■ Characteristics

<b>Display range</b>		-19,999 to 99,999
<b>Sampling period</b>		20 ms (50 times/second)
<b>Comparative output response time</b>		100 ms max.
<b>Linear output response time</b>		150 ms max.
<b>Insulation resistance</b>		20 MΩ min. (at 500 VDC)
<b>Dielectric strength</b>		2,300 VAC for 1 min between external terminals and case
<b>Noise immunity</b>		100 to 240 VAC models: ±1,500 V at power supply terminals in normal or common mode (waveform with 1-ns rising edge and pulse width of 1 μs/100 ns) 24 VAC/VDC models: ±1,500 V at power supply terminals in normal or common mode (waveform with 1-ns rising edge and pulse width of 1 μs/100 ns)
<b>Vibration resistance</b>		Frequency: 10 to 55 Hz; Acceleration: 50 m/s <sup>2</sup> , 10 sweeps of 5 min each in X, Y, and Z directions
<b>Shock resistance</b>		150 m/s <sup>2</sup> (100 m/s <sup>2</sup> for relay outputs) 3 times each in 3 axes, 6 directions
<b>Weight</b>		Approx. 300 g (Digital Indicator only)
<b>Degree of protection</b>	<b>Front panel</b>	Conforms to NEMA 4X for indoor use (equivalent to IP66)
	<b>Rear case</b>	IP20
	<b>Terminals</b>	IP00 + finger protection (VDE0106/100)
<b>Memory protection</b>		EEPROM (non-volatile memory) Number of rewrites: 100,000
<b>Applicable standards</b>		UL61010C-1, CSA C22.2 No. 1010.1 (approval pending) EN61010-1 (IEC61010-1): Pollution degree 2/Overvoltage category II EN61326: 1997, A1: 1998, A2: 2001
<b>EMC</b>		EMI: EN61326+A1 industrial applications Electromagnetic radiation interference CISPR 11 Group 1, Class A: CISPRL16-1/-2 Terminal interference voltage CISPR 11 Group 1, Class A: CISPRL16-1/-2 EMS: EN61326+A1 industrial applications Electrostatic Discharge Immunity EN61000-4-2: 4 kV (contact), 8 kV (in air) Radiated Electromagnetic Field Immunity EN61000-4-3: 10 V/m 1 kHz sine wave amplitude modulation (80 MHz to 1 GHz) Electrical Fast Transient/Burst Immunity EN61000-4-4: 2 kV (power line), 1 kV (I/O signal line) Surge Immunity EN61000-4-5: 1 kV with line (power line), 2 kV with ground (power line) Conducted Disturbance Immunity EN61000-4-6: 3 V (0.15 to 80 MHz) Voltage Dips and Interruptions Immunity EN61000-4-11: 0.5 cycle, 0°/180°, 100% (rated voltage)

## Input Ranges (Measurement Range and Accuracy)

Input type	Range	Set value	Measurement range	Input impedance	Accuracy	Allowable instantaneous overload (30 s)
K3HB-VLC Load Cell, mV	A	$R \ U_d$	0.00 to 199.99 mV	1 M $\Omega$ min.	$\pm 0.1\%rdg \pm 1$ digit max.	$\pm 200$ V
	B	$b \ U_d$	0.000 to 19.999 mV		$\pm 0.1\%rdg \pm 5$ digits max.	
	C	$c \ U_d$	$\pm 100.00$ mV		$\pm 0.1\%rdg \pm 3$ digits max.	
	D	$d \ U_d$	$\pm 199.99$ mV		$\pm 0.1\%rdg \pm 1$ digit max.	

**Note:** 1. The accuracy is for an ambient temperature of 23 $\pm$ 5 $^{\circ}$ C. For all ranges, 10% or less of max. input  $\pm 0.1\%$  FS.  
 2. The letters "rdg" mean "reading."

Input type Connected terminals	$R \ L \ L$	$b \ L \ L$	$c \ L \ L$	$d \ L \ L$
	$(E2) - (E6)$	$(E3) - (E6)$	$(E4) - (E6)$	$(E5) - (E6)$
(mV)	199.99			199.99
200.000	[Dark shaded area from 0.00 to 199.99]			[Dark shaded area from -199.99 to 199.99]
150.000				
100.000				
50.000				
0.00				
-50.00		19.999		
-100.00		[Dark shaded area from 0.000 to 19.999]		
-150.00		0.000		
-200.00			100.00	
			[Dark shaded area from -100.00 to 100.00]	
			-100.00	
				-199.99

The area shown in dark shading indicates the factory setting.

## Load Cell Wiring Example

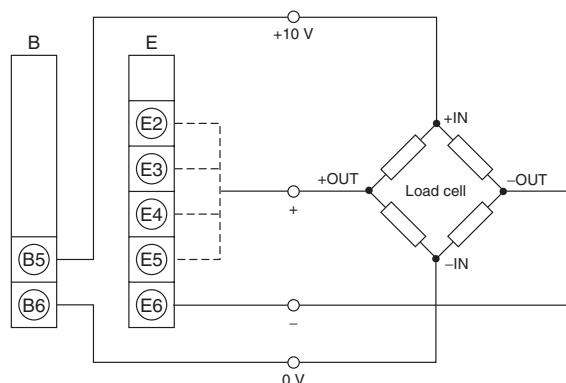

## Scaling Example Using Range A

Indicated on the K3HB-V as 0 to 49N in the load cell specifications (rated load 49N, recommended applied voltage 10 V, rated output 2 mV/V) (See note.)

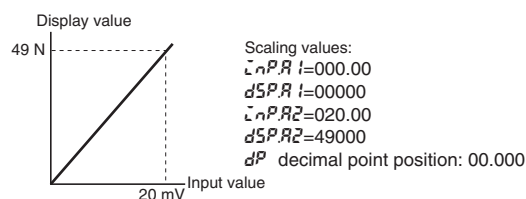

**Note:** 2 mV/V indicates a load cell output of 2 mV for 1 V applied voltage for the rated load (when using a load of 1 N). When the applied voltage is 10 V, the load cell output is 20 mV (2 mV  $\times$  10).

# K3HB-H Temperature Indicator

## New High-speed, High-precision Temperature Indicator

- Easy recognition of judgement results using color display that can be switched between red and green.
- Equipped with a position meter for monitoring operating status trends.
- External event input allows use in various measurement and discrimination applications.
- Series expanded to include DeviceNet models.
- Short body with depth of only 95 mm (from behind the front panel), or 97 mm for DeviceNet models.
- UL certification approval (Certification Mark License).
- CE Marking conformance by third party assessment body.
- Water-resistant enclosure conforms to NEMA 4X (equivalent to IP66).
- Capable of high-speed sampling at 50 times per second (20 ms).
- High-resolution of 0.01°C with platinum-resistance thermometer Pt100 input. Thermocouple sensor inputs also support a resolution of 0.1°C for all ranges.
- Temperature input shift is easily set using two points.



## Model Number Structure

### Model Number Legend

Base Units and Optional Boards can be ordered individually.

#### Base Units

K3HB-H    
1 2

##### 1. Input Sensor Codes

TA: Temperature input,  
Thermocouple input/Platinum resistance  
Thermometer input

##### 2. Supply Voltage

100240VAC: 100 to 240 VAC  
24VACVDC: 24 VAC/VDC

#### Optional Boards

##### Sensor Power Supply/Output Boards

K33-  
3

##### 3. Sensor Power Supply/Output Type Codes

None: None  
CPA: Relay output (PASS: SPDT) + Sensor power supply  
(12 VDC +/-10%, 80 mA) (See note 1.)  
CPB: Relay output (PASS: SPDT) + Sensor power supply  
(10 VDC +/-5%, 100 mA) (See note 1.)  
L1A: Linear current output (DC0(4) - 20 mA) + Sensor power supply  
(12 VDC +/-10%, 80 mA) (See note 2.)  
L1B: Linear current output (DC0(4) - 20 mA) + Sensor power supply  
(10 VDC +/-5%, 100 mA) (See note 2.)  
L2A: Linear voltage output (DC0(1) - 5 V, 0 to 10 V) + Sensor power supply  
(12 VDC +/-10%, 80 mA) (See note 2.)  
L2B: Linear voltage output (DC0(1) - 5 V, 0 to 10 V) + Sensor power supply  
(10 VDC +/-5%, 100 mA) (See note 2.)  
A: Sensor power supply (12 VDC +/-10%, 80 mA)  
B: Sensor power supply (10 VDC +/-5%, 100 mA)  
FLK1A: Communications (RS-232C) + Sensor power supply  
(12 VDC +/-10%, 80 mA) (See note 2.)  
FLK1B: Communications (RS-232C) + Sensor power supply  
(10 VDC +/-5%, 100 mA) (See note 2.)  
FLK3A: Communications (RS-485) + Sensor power supply  
(12 VDC +/-10%, 80 mA) (See note 2.)  
FLK3B: Communications (RS-485) + Sensor power supply  
(10 VDC +/-5%, 100 mA) (See note 2.)

- Note:** 1. CPA and CPB can be combined with relay outputs only.  
2. Only one of communications, BCD, or DeviceNet can be used by each Digital indicator.

## Relay/Transistor Output Boards

K34-□  
4

### 4. Relay/Transistor Output Type Codes

- None: None
- C1: Relay contact (H/L: SPDT each)
- C2: Relay contact (HH/H/LL/L: SPST-NO each)
- T1: Transistor (NPN open collector: HH/H/PASS/L/LL)
- T2: Transistor (PNP open collector: HH/H/PASS/L/LL)
- DRT: DeviceNet (See note 2.)

- Note:** 1. CPA and CPB can be combined with relay outputs only.  
2. Only one of communications, BCD, or DeviceNet can be used by each Digital indicator.

## ■ Accessories (Sold Separately)

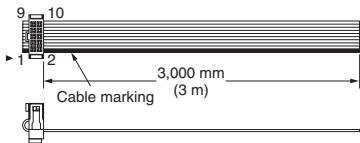
Name	Appearance	Wiring	Model																						
Special Cable (for event inputs with 8-pin connector)		<table border="1"> <thead> <tr> <th>Pin No.</th> <th>Signal name</th> </tr> </thead> <tbody> <tr><td>1</td><td>TIMING</td></tr> <tr><td>2</td><td>S-TMR</td></tr> <tr><td>3</td><td>HOLD</td></tr> <tr><td>4</td><td>RESET</td></tr> <tr><td>5</td><td>ZERO</td></tr> <tr><td>6</td><td>COM</td></tr> <tr><td>7</td><td>BANK4</td></tr> <tr><td>8</td><td>BANK2</td></tr> <tr><td>9</td><td>BANK1</td></tr> <tr><td>10</td><td>COM</td></tr> </tbody> </table>	Pin No.	Signal name	1	TIMING	2	S-TMR	3	HOLD	4	RESET	5	ZERO	6	COM	7	BANK4	8	BANK2	9	BANK1	10	COM	K32-DICN
Pin No.	Signal name																								
1	TIMING																								
2	S-TMR																								
3	HOLD																								
4	RESET																								
5	ZERO																								
6	COM																								
7	BANK4																								
8	BANK2																								
9	BANK1																								
10	COM																								

## Event Input Boards

K35-□  
5

### 5. Event input Type Codes

- None: None
- 1: 5 points (M3 terminal blocks) NPN open collector
- 2: 8 points (10-pin MIL connector) NPN open collector
- 3: 5 points (M3 terminal blocks) PNP open collector
- 4: 8 points (10-pin MIL connector) PNP open collector

# Specifications

## ■ Ratings

<b>Power supply voltage</b>		100 to 240 VAC (50/60 Hz), 24 VAC/VDC, DeviceNet power supply: 24 VDC
<b>Allowable power supply voltage range</b>		85% to 110% of the rated power supply voltage, DeviceNet power supply: 11 to 25 VDC
<b>Power consumption (See note 1.)</b>		100 to 240 V: 18 VA max. (max. load) 24 VAC/DC: 11 VA/7 W max. (max. load)
<b>Current consumption</b>		DeviceNet power supply: 50 mA max. (24 VDC)
<b>Input</b>		Platinum-resistance thermometer: Pt100 Thermocouple: K, J, T, E, L, U, N, R, S, B, W
<b>A/D conversion method</b>		Delta-Sigma method
<b>External power supply</b>		See Sensor Power Supply/Output Type Codes
<b>Event inputs (See note 2.)</b>	<b>Timing input</b>	NPN open collector or no-voltage contact signal ON residual voltage: 3 V max.
	<b>Startup compensation timer input</b>	ON current at 0 $\Omega$ : 17 mA max. Max. applied voltage: 30 VDC max. OFF leakage current: 1.5 mA max.
	<b>Hold input</b>	NPN open collector or no-voltage contact signal ON residual voltage: 2 V max.
	<b>Reset input</b>	ON current at 0 $\Omega$ : 4 mA max.
	<b>Bank input</b>	Max. applied voltage: 30 VDC max. OFF leakage current: 0.1 mA max.
<b>Output ratings (depends on the model)</b>	<b>Relay output</b>	250 VAC, 30 VDC, 5 A (resistive load) Mechanical life expectancy: 5,000,000 operations, Electrical life expectancy: 100,000 operations
	<b>Transistor output</b>	Maximum load voltage: 24 VDC, Maximum load current: 50 mA, Leakage current: 100 $\mu$ A max.
	<b>Linear output</b>	Linear output 0 to 20 mA DC, 4 to 20 mA: Load: 500 $\Omega$ max, Resolution: Approx. 10,000, Output error: $\pm$ 0.5% FS Linear output 0 to 5 VDC, 1 to 5 VDC, 0 to 10 VDC: Load: 5 k $\Omega$ max, Resolution: Approx. 10,000, Output error: $\pm$ 0.5% FS (1 V or less: $\pm$ 0.15 V; not output for 0 V or less)
<b>Display method</b>		Negative LCD (backlit LED) display 7-segment digital display (Character height: PV: 14.2 mm (green/red); SV: 4.9 mm (green))
<b>Main functions</b>		Scaling function, measurement operation selection, averaging, previous average value comparison, zero-limit, output hysteresis, output OFF delay, output test, display value selection, display color selection, key protection, bank selection, display refresh period, maximum/minimum hold, reset
<b>Ambient operating temperature</b>		-10 to 55°C (with no icing or condensation)
<b>Ambient operating humidity</b>		25% to 85%
<b>Storage temperature</b>		-25 to 65°C (with no icing or condensation)
<b>Altitude</b>		2,000 m max.
<b>Accessories</b>		Watertight packing, 2 fixtures, terminal cover, unit stickers, instruction manual. DeviceNet models also include a DeviceNet connector (Hirose HR31-5.08P-5SC(01)) and crimp terminals (Hirose HR31-SC-121) (See note 3.)

- Note:**
1. DC power supply models require a control power supply capacity of approximately 1 A per Unit when power is turned ON. Particular attention is required when using two or more DC power supply models. The OMRON S8VS-series DC Power Supply Unit is recommended.
  2. PNP input types are also available
  3. For K3HB-series DeviceNet models, use only the DeviceNet Connector included with the product. The crimp terminals provided are for Thin Cables.



## ■ Characteristics

<b>Display range</b>	-19,999 to 99,999	
<b>Accuracy</b>	Thermocouple input: ( $\pm 0.3\%$ PV or $\pm 1^\circ\text{C}$ , whichever is larger) $\pm 1$ digit max. (See note.) Platinum resistance thermometer input: ( $\pm 0.2\%$ PV or $\pm 0.8^\circ\text{C}$ , whichever is larger) $\pm 1$ digit max.	
<b>Sampling period</b>	20 ms (50 times/second)	
<b>Comparative output response time</b>	Platinum-resistance thermometer input range: 120 ms max. Thermocouple input range: 180 ms max.	
<b>Linear output response time</b>	Platinum-resistance thermometer input range: 170 ms max. Thermocouple input range: 230 ms max.	
<b>Insulation resistance</b>	20 M $\Omega$ min. (at 500 VDC)	
<b>Dielectric strength</b>	2,300 VAC for 1 min between external terminals and case	
<b>Noise immunity</b>	100 to 240 VAC models: $\pm 1,500$ V at power supply terminals in normal or common mode (waveform with 1-ns rising edge and pulse width of 1 $\mu\text{s}/100$ ns) 24 VAC/VDC models: $\pm 1,500$ V at power supply terminals in normal or common mode (waveform with 1-ns rising edge and pulse width of 1 $\mu\text{s}/100$ ns)	
<b>Vibration resistance</b>	Frequency: 10 to 55 Hz; Acceleration: 50 m/s <sup>2</sup> , 10 sweeps of 5 min each in X, Y, and Z directions	
<b>Shock resistance</b>	150 m/s <sup>2</sup> (100 m/s <sup>2</sup> for relay outputs) 3 times each in 3 axes, 6 directions	
<b>Weight</b>	Approx. 300 g (Digital Indicator only)	
<b>Degree of protection</b>	<b>Front panel</b>	Conforms to NEMA 4X for indoor use (equivalent to IP66)
	<b>Rear case</b>	IP20
	<b>Terminals</b>	IP00 + finger protection (VDE0106/100)
<b>Memory protection</b>	EEPROM (non-volatile memory) Number of rewrites: 100,000	
<b>Applicable standards</b>	UL61010C-1, CSA C22.2 No. 1010.1 (approval pending) EN61010-1 (IEC61010-1): Pollution degree 2/Overvoltage category II EN61326: 1997, A1: 1998, A2: 2001	
<b>EMC</b>	EMI: EN61326+A1 industrial applications Electromagnetic radiation interference CISPR 11 Group 1, Class A: CISPR16-1/-2 Terminal interference voltage CISPR 11 Group 1, Class A: CISPR16-1/-2 EMS: EN61326+A1 industrial applications Electrostatic Discharge Immunity EN61000-4-2: 4 kV (contact), 8 kV (in air) Radiated Electromagnetic Field Immunity EN61000-4-3: 10 V/m 1 kHz sine wave amplitude modulation (80 MHz to 1 GHz) Electrical Fast Transient/Burst Immunity EN61000-4-4: 2 kV (power line), 1 kV (I/O signal line) Surge Immunity EN61000-4-5: 1 kV with line (power line), 2 kV with ground (power line) Conducted Disturbance Immunity EN61000-4-6: 3 V (0.15 to 80 MHz) Voltage Dips and Interruptions Immunity EN61000-4-11: 0.5 cycle, 0°/180°, 100% (rated voltage)	

**Note:** K, T, N ( $-100^\circ\text{C}$  or less):  $\pm 2^\circ\text{C} \pm 1$  digit max.  
U, L:  $\pm 2^\circ\text{C} \pm 1$  digit max.  
B (400 $^\circ\text{C}$  max.): Nothing specified.  
R, S (200 $^\circ\text{C}$  max.):  $\pm 3^\circ\text{C} \pm 1$  digit max.  
W: ( $\pm 0.3\%$  PV or  $\pm 3^\circ\text{C}$  whichever is larger)  $\pm 1$  digit max.

## Input Ranges

### Platinum-resistance Thermometer/Thermocouple

Input type	Platinum-resistance thermometer		Thermocouple												
Name	Pt100		K	J	T	E	L	U	N	R	S	B	W (W/Re 5-26)		
Connected terminals	(E5) - (E6)		(E4) - (E5) - (E6)												
Temperature range (°C)	2300												2300.0		
	1800												1800.0		
	1300		1300.0						1300.0				1300.0		
	900	850.0		850.0			850.0						900.0		
	800												800.0		
	700												700.0		
	600			500.0									600.0		
	500												500.0		
	400				400.0								400.0		
	300												300.0		
	200												200.0		
	100	150.00											100.0		
	0												0.0		
	-100												-100.0		
	-200	-200.0	-200.0	-20.0	-100.0	-20.0	-200.0	0.0	-100.0	-200.0	-200.0		-200.0		
Setting code	0-Pt	1-Pt	2-U	3-U	4-J	5-J	6-E	7-E	8-L	9-U	10-N	11-R	12-S	13-B	14-W
Minimum setting unit (comparative set value)	0.1°C	0.01°C	0.1°C												

The range shown in dark shading indicates the factory setting.

### Celsius/Fahrenheit Correlation Values and Setting/Specified Ranges

Input type	Setting range		Indication range	
	°C	°F	°C	°F
Pt100 (1)	-200.0 to 850.0	-300.0 to 1500.0	-305.0 to 955.0	-480.0 to 1680.0
Pt100 (2)	-150.00 to 150.00	-199.99 to 300.00	-180.00 to 180.00	-199.99 to 350.00
K (1)	-200.0 to 1300.0	-300.0 to 2300.0	-350.0 to 1450.0	-560.0 to 2560.0
K (2)	-20.0 to 500.0	0.0 to 900.0	-72.0 to 552.0	-90.0 to 990.0
J (1)	-100.0 to 850.0	-100.0 to 1500.0	-195.0 to 945.0	-260.0 to 1660.0
J (2)	-20.0 to 400.0	0.0 to 750.0	-62.0 to 442.0	-75.0 to 825.0
T	-200.0 to 400.0	-300.0 to 700.0	-260.0 to 460.0	-400.0 to 800.0
E	0.0 to 600.0	0.0 to 1100.0	-60.0 to 660.0	-110.0 to 1210.0
L	-100.0 to 850.0	-100.0 to 1500.0	-195.0 to 945.0	-260.0 to 1660.0
U	-200.0 to 400.0	-300.0 to 700.0	-260.0 to 460.0	-400.0 to 800.0
N	-200.0 to 1300.0	-300.0 to 2300.0	-350.0 to 1450.0	-560.0 to 2560.0
R	0.0 to 1700.0	0.0 to 3000.0	-170.0 to 1870.0	-300.0 to 3300.0
S	0.0 to 1700.0	0.0 to 3000.0	-170.0 to 1870.0	-300.0 to 3300.0
B	100.0 to 1800.0	300.0 to 3200.0	-70.0 to 1970.0	10.0 to 3490.0
W	0.0 to 2300.0	0.0 to 4100.0	-230.0 to 2530.0	-410.0 to 4510.0

# K3HB-S Linear Sensor Indicator

## A Linear Sensor Indicator Capable of High-speed Response at 2,000 Times per Second

- Effective for high-speed measurement and discrimination from 1 or 2 analog inputs with a sampling period of 0.5 ms and output response time of 1 ms max.
- Easy recognition of judgement results using color display that can be switched between red and green.
- Equipped with a position meter that represents measured amounts and relative positions.
- Zero calibration can be performed easily with the forced zero function.
- Series expanded to include DeviceNet models.
- Short body with depth of only 95 mm (from behind the front panel), or 97 mm for DeviceNet models.
- UL certification approval (Certification Mark License).
- CE Marking conformance by third party assessment body.
- Water-resistant enclosure conforms to NEMA 4X (equivalent to IP66).



## Model Number Structure

### ■ Model Number Legend

Base Units and Optional Boards can be ordered individually.

#### Base Units

K3HB-S    
1 2

- 1. Input Sensor Codes**  
SD: DC process input
- 2. Supply Voltage**  
100240VAC: 100 to 240 VAC  
24VACVDC: 24 VAC/VDC

#### Optional Boards

##### Sensor Power Supply/Output Boards

K33-  
3

- 3. Sensor Power Supply/Output Type Codes**  
None: None  
CPA: Relay output (PASS: SPDT) + Sensor power supply (12 VDC +/-10%, 80 mA) (See note 1.)  
CPB: Relay output (PASS: SPDT) + Sensor power supply (10 VDC +/-5%, 100 mA) (See note 1.)  
L1A: Linear current output (DC0(4) - 20 mA) + Sensor power supply (12 VDC +/-10%, 80 mA) (See note 2.)  
L1B: Linear current output (DC0(4) - 20 mA) + Sensor power supply (10 VDC +/-5%, 100 mA) (See note 2.)  
L2A: Linear voltage output (DC0(1) - 5 V, 0 to 10 V) + Sensor power supply (12 VDC +/-10%, 80 mA) (See note 2.)  
L2B: Linear voltage output (DC0(1) - 5 V, 0 to 10 V) + Sensor power supply (10 VDC +/-5%, 100 mA) (See note 2.)  
A: Sensor power supply (12 VDC +/-10%, 80 mA)  
B: Sensor power supply (10 VDC +/-5%, 100 mA)  
FLK1A: Communications (RS-232C) + Sensor power supply (12 VDC +/-10%, 80 mA) (See note 2.)  
FLK1B: Communications (RS-232C) + Sensor power supply (10 VDC +/-5%, 100 mA) (See note 2.)  
FLK3A: Communications (RS-485) + Sensor power supply (12 VDC +/-10%, 80 mA) (See note 2.)  
FLK3B: Communications (RS-485) + Sensor power supply (10 VDC +/-5%, 100 mA) (See note 2.)

- Note:** 1. CPA and CPB can be combined with relay outputs only.  
2. Only one of communications, BCD, or DeviceNet can be used by each Digital indicator.

## Relay/Transistor Output Boards

K34-□  
4

### 4. Relay/Transistor Output Type Codes

- None: None
- C1: Relay contact (H/L: SPDT each)
- C2: Relay contact (HH/H/LL/L: SPST-NO each)
- T1: Transistor (NPN open collector: HH/H/PASS/L/LL)
- T2: Transistor (PNP open collector: HH/H/PASS/L/LL)
- DRT: DeviceNet (See note 2.)

**Note:** 1. CPA and CPB can be combined with relay outputs only.

- 2. Only one of communications, BCD, or DeviceNet can be used by each Digital indicator.

## Event Input Boards

K35-□  
5

### 5. Event input Type Codes

- None: None
- 1: 5 points (M3 terminal blocks) NPN open collector
- 2: 8 points (10-pin MIL connector) NPN open collector
- 3: 5 points (M3 terminal blocks) PNP open collector
- 4: 8 points (10-pin MIL connector) PNP open collector

## ■ Accessories (Sold Separately)

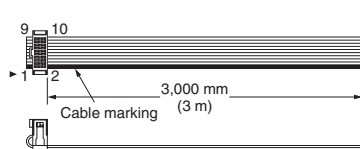
Name	Appearance	Wiring	Model																						
Special Cable (for event inputs with 8-pin connector)		<table border="1"> <thead> <tr> <th>Pin No.</th> <th>Signal name</th> </tr> </thead> <tbody> <tr><td>1</td><td>TIMING</td></tr> <tr><td>2</td><td>S-TMR</td></tr> <tr><td>3</td><td>HOLD</td></tr> <tr><td>4</td><td>RESET</td></tr> <tr><td>5</td><td>ZERO</td></tr> <tr><td>6</td><td>COM</td></tr> <tr><td>7</td><td>BANK4</td></tr> <tr><td>8</td><td>BANK2</td></tr> <tr><td>9</td><td>BANK1</td></tr> <tr><td>10</td><td>COM</td></tr> </tbody> </table>	Pin No.	Signal name	1	TIMING	2	S-TMR	3	HOLD	4	RESET	5	ZERO	6	COM	7	BANK4	8	BANK2	9	BANK1	10	COM	K32-DICN
Pin No.	Signal name																								
1	TIMING																								
2	S-TMR																								
3	HOLD																								
4	RESET																								
5	ZERO																								
6	COM																								
7	BANK4																								
8	BANK2																								
9	BANK1																								
10	COM																								

## Specifications

### ■ Ratings

<b>Power supply voltage</b>	100 to 240 VAC (50/60 Hz), 24 VAC/VDC, DeviceNet power supply: 24 VDC	
<b>Allowable power supply voltage range</b>	85% to 110% of the rated power supply voltage, DeviceNet power supply: 11 to 25 VDC	
<b>Power consumption</b> (See note 1.)	100 to 240 V: 18 VA max. (max. load) 24 VAC/DC: 11 VA/7 W max. (max. load)	
<b>Current consumption</b>	DeviceNet power supply: 50 mA max. (24 VDC)	
<b>Input</b>	DC voltage/current	
<b>A/D conversion method</b>	Sequential comparison system	
<b>External power supply</b>	See Sensor Power Supply/Output Type Codes	
<b>Event inputs</b> (See note 2.)	<b>Timing input</b>	NPN open collector or no-voltage contact signal
	<b>Startup compensation timer input</b>	ON residual voltage: 3 V max. ON current at 0 Ω: 17 mA max. Max. applied voltage: 30 VDC max. OFF leakage current: 1.5 mA max.
	<b>Hold input</b>	NPN open collector or no-voltage contact signal
	<b>Reset input</b>	ON residual voltage: 2 V max. ON current at 0 Ω: 4 mA max.
	<b>Forced-zero input</b>	Max. applied voltage: 30 VDC max.
	<b>Bank input</b>	OFF leakage current: 0.1 mA max.

<b>Output ratings (depends on the model)</b>	<b>Relay output</b>	250 VAC, 30 VDC, 5 A (resistive load) Mechanical life expectancy: 5,000,000 operations, Electrical life expectancy: 100,000 operations
	<b>Transistor output</b>	Maximum load voltage: 24 VDC, Maximum load current: 50 mA, Leakage current: 100 $\mu$ A max.
	<b>Linear output</b>	Linear output 0 to 20 mA DC, 4 to 20 mA: Load: 500 $\Omega$ max, Resolution: Approx. 10,000, Output error: $\pm$ 0.5% FS Linear output 0 to 5 VDC, 1 to 5 VDC, 0 to 10 VDC: Load: 5 k $\Omega$ max, Resolution: Approx. 10,000, Output error: $\pm$ 0.5% FS (1 V or less: $\pm$ 0.15 V; not output for 0 V or less)
<b>Display method</b>	Negative LCD (backlit LED) display 7-segment digital display (Character height: PV: 14.2 mm (green/red); SV: 4.9 mm (green))	
<b>Main functions</b>	Scaling function, 2-input calculation function, measurement operation selection, averaging, previous average value comparison, forced-zero, zero-limit, output hysteresis, output OFF delay, output test, teaching, display value selection, display color selection, key protection, bank selection, display refresh period, maximum/minimum hold, reset	
<b>Ambient operating temperature</b>	-10 to 55°C (with no icing or condensation)	
<b>Ambient operating humidity</b>	25% to 85%	
<b>Storage temperature</b>	-25 to 65°C (with no icing or condensation)	
<b>Altitude</b>	2,000 m max.	
<b>Accessories</b>	Watertight packing, 2 fixtures, terminal cover, unit stickers, instruction manual. DeviceNet models also include a DeviceNet connector (Hirose HR31-5.08P-5SC(01)) and crimp terminals (Hirose HR31-SC-121) (See note 3.)	

- Note:**
1. DC power supply models require a control power supply capacity of approximately 1 A per Unit when power is turned ON. Particular attention is required when using two or more DC power supply models. The OMRON S8VS-series DC Power Supply Unit is recommended.
  2. PNP input types are also available
  3. For K3HB-series DeviceNet models, use only the DeviceNet Connector included with the product. The crimp terminals provided are for Thin Cables.

## ■ Characteristics

<b>Display range</b>		-19,999 to 99,999
<b>Sampling period</b>		One input: 0.5 ms; Two inputs: 1.0 ms
<b>Comparative output response times (transistor outputs)</b>	<b>One input</b>	OFF to ON: 1 ms max., ON to OFF: 1.5 ms max.
	<b>Two inputs</b>	OFF to ON: 2 ms max., ON to OFF: 2.5 ms max.
<b>Linear output response time</b>	<b>One input</b>	51 ms max.
	<b>Two inputs</b>	52 ms max.
<b>Insulation resistance</b>		20 M $\Omega$ min. (at 500 VDC)
<b>Dielectric strength</b>		2,300 VAC for 1 min between external terminals and case
<b>Noise immunity</b>		100 to 240 VAC models: ±1,500 V at power supply terminals in normal or common mode (waveform with 1-ns rising edge and pulse width of 1 $\mu$ s/100 ns) 24 VAC/VDC models: ±1,500 V at power supply terminals in normal or common mode (waveform with 1-ns rising edge and pulse width of 1 $\mu$ s/100 ns)
<b>Vibration resistance</b>		Frequency: 10 to 55 Hz; Acceleration: 50 m/s <sup>2</sup> , 10 sweeps of 5 min each in X, Y, and Z directions
<b>Shock resistance</b>		150 m/s <sup>2</sup> (100 m/s <sup>2</sup> for relay outputs) 3 times each in 3 axes, 6 directions
<b>Weight</b>		Approx. 300 g (Digital Indicator only)
<b>Degree of protection</b>	<b>Front panel</b>	Conforms to NEMA 4X for indoor use (equivalent to IP66)
	<b>Rear case</b>	IP20
	<b>Terminals</b>	IP00 + finger protection (VDE0106/100)
<b>Memory protection</b>		EEPROM (non-volatile memory) Number of rewrites: 100,000
<b>Applicable standards</b>		UL61010C-1, CSA C22.2 No. 1010.1 EN61010-1 (IEC61010-1): Pollution degree 2/Overvoltage category II EN61326: 1997, A1: 1998, A2: 2001
<b>EMC</b>		EMI: EN61326+A1 industrial applications Electromagnetic radiation interference CISPR 11 Group 1, Class A: CISPRL16-1/-2 Terminal interference voltage CISPR 11 Group 1, Class A: CISPRL16-1/-2 EMS: EN61326+A1 industrial applications Electrostatic Discharge Immunity EN61000-4-2: 4 kV (contact), 8 kV (in air) Radiated Electromagnetic Field Immunity EN61000-4-3: 10 V/m 1 kHz sine wave amplitude modulation (80 MHz to 1 GHz) Electrical Fast Transient/Burst Immunity EN61000-4-4: 2 kV (power line), 1 kV (I/O signal line) Surge Immunity EN61000-4-5: 1 kV with line (power line), 2 kV with ground (power line) Conducted Disturbance Immunity EN61000-4-6: 3 V (0.15 to 80 MHz) Voltage Dips and Interruptions Immunity EN61000-4-11: 0.5 cycle, 0°/180°, 100% (rated voltage)

## ■ Input Ranges (Measurement Ranges and Accuracy)

Input	Input type	Measurement range	Indication range	Input impedance	Accuracy (at 23±5°C)	Maximum absolute rated input
K3HB-SSD DC voltage/current input	0 to 20 mA	0.000 to 20.000 mA	-2.000 to 22.000 mA	120 $\Omega$ max.	One input: ±0.1% F.S. ±1 digit max.	±31 mA
	4 to 20 mA	4.000 to 20.000 mA	2.000 to 22.000 mA			
	0 to 5 V	0.000 to 5.000 V	-0.500 to 5.500 mA	1 M $\Omega$ min.	Two inputs: ±0.2% F.S. ±1 digit max.	±10 V
	1 to 5 V	1.000 to 5.000 V	0.500 to 5.500 V			
	±5 V	±5.000 V	± 5.500 V			
	±10 V	±10.000 V	± 11.000 V			

**Note:** The accuracy is for an ambient temperature of 23±5°C.

Input type		DC current input		Input type		DC voltage input			
Connected terminals		0-20	4-20	Connected terminals		0-5	1-5	5	10
Input A	0-1A	(E2) - (E3)		Input A	0-1A	(E4) - (E3)			
Input B	0-1A	(E1) - (E3)		Input B	0-1A	(E5) - (E3)			
DC current range (mA)	24.000	22.000	22.000	DC voltage range (V)					
	20.000				10.000				
	16.000			5.000	5.500	5.500	5.500		
	12.000			0.000	-0.500	0.500			
	8.000			-5.000			-5.500		
	4.000			-10.000					
	0.000								
	-4.000								
		-2.000	2.000						

The range shown in dark shading indicates the factory setting.

## Sampling and Comparative Output Response Times

The K3HB-S sampling and comparative output response times depend on the calculation methods, timing hold type, and, for simple averaging, the averaging times. Refer to the following description for details.

### Output Refresh Period

The K3HB-S repeats input reads, calculation, and judgement output processing. The output refresh period differs depending on whether there are one or two inputs, as outlined below.

#### One Input

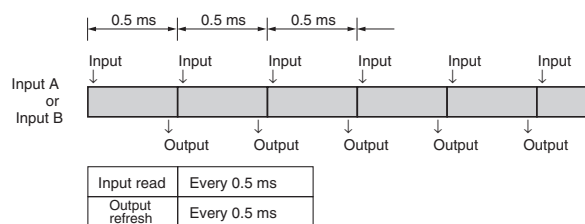

#### Two Inputs

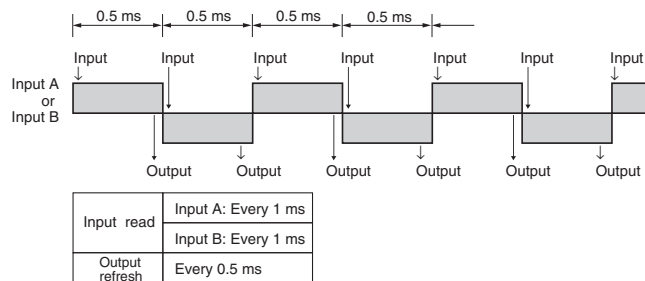

### Output Response Time

The comparative output response time is the sum of the data processing time and the output (relay or transistor) response time.

#### One Input

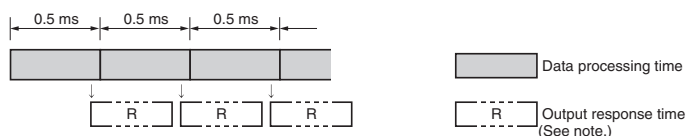

#### Two Inputs

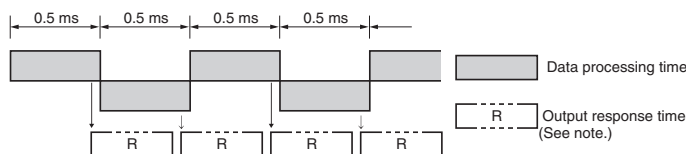

**Note:** For transistor outputs:

For one input: OFF to ON 1 ms and ON to OFF 1.5 ms

For two inputs: OFF to ON 2 ms and ON to OFF 2.5 ms

For relay outputs:

The relay operation time of 15 ms is added to the transistor output response times.

# Common Specifications

## ■ Event Input Ratings

Input type	S-TMR, HOLD, RESET, ZERO, BANK1, BANK2, BANK4	Timing
Contact	ON: 1 kΩ max., OFF: 100 kΩ min.	---
No-contact	ON residual voltage: 2 V max. OFF leakage current: 0.1 mA max. Load current: 4 mA max. Maximum applied voltage: 30 VDC max.	ON residual voltage: 3 V max. OFF leakage current: 1.5 mA max. Load current: 17 mA max. Maximum applied voltage: 30 VDC max.

## ■ Output Ratings

### Contact Output

Item	Resistive loads (250 VAC, cosφ=1; 30 VDC, L/R=0 ms)	Inductive loads (250 VAC, closed circuit, cosφ=0.4; 30 VDC, L/R=7 ms)
Rated load	5 A at 250 VAC 5 A at 30 VDC	1 A at 250 VAC 1 A at 30 VDC
Rated through current	5A	
Mechanical life expectancy	5,000,000 operations	
Electrical life expectancy	100,000 operations	

### Transistor Output

Maximum load voltage	24 VDC
Maximum load current	50 mA
Leakage current	100 μA max.

### Linear Output

Item	0 to 20 mA	4 to 20 mA	0 to 5 V	1 to 5 V	0 to 10 V
Allowable load impedance	500 Ω max.		5 kΩ min.		
Resolution	Approx. 10,000				
Output error	±0.5%FS				

### Serial Communications Output

Item	RS-232C, RS-485
Communications method	Half duplex
Synchronization method	Start-stop synchronization
Baud rate	9,600, 19,200, or 38,400 bps
Transmission code	ASCII
Data length	7 bits or 8 bits
Stop bit length	2 bits or 1 bit
Error detection	Vertical parity and FCS
Parity check	Odd, even

**Note:** For details on serial and DeviceNet communications, refer to the *Digital Indicator K3HB Communications User's Manual* (Cat.No. N129).



## DeviceNet Communications

<b>Communications protocol</b>		Conforms to DeviceNet																	
<b>Supported communications</b>	<b>Remote I/O communications</b>	Master-Slave connection (polling, bit-strobe, COS, cyclic) Conforms to DeviceNet communications standards.																	
	<b>I/O allocations</b>	Allocate any I/O data using the Configurator. Allocate any data, such as DeviceNet-specific parameters and variable area for Digital Indicators. Input area: 2 blocks, 60 words max. Output area: 1 block, 29 words max. (The first word in the area is always allocated for the Output Execution Enabled Flags.)																	
	<b>Message communications</b>	Explicit message communications CompoWay/F communications commands can be executed (using explicit message communications)																	
<b>Connection methods</b>		Combination of multi-drop and T-branch connections (for trunk and drop lines)																	
<b>Baud rate</b>		DeviceNet: 500, 250, or 125 Kbps (automatic follow-up)																	
<b>Communications media</b>		Special 5-wire cable (2 signal lines, 2 power supply lines, 1 shield line)																	
<b>Communications distance</b>		<table border="1"> <thead> <tr> <th>Baud rate</th> <th>Network length (max.)</th> <th>Drop line length (max.)</th> <th>Total drop line length (max.)</th> </tr> </thead> <tbody> <tr> <td>500 Kbps</td> <td>100 m (100 m)</td> <td>6 m</td> <td>39 m</td> </tr> <tr> <td>250 Kbps</td> <td>100 m (250 m)</td> <td>6 m</td> <td>78 m</td> </tr> <tr> <td>125 Kbps</td> <td>100 m (500 m)</td> <td>6 m</td> <td>156 m</td> </tr> </tbody> </table> <p>The values in parentheses are for Thick Cable.</p>		Baud rate	Network length (max.)	Drop line length (max.)	Total drop line length (max.)	500 Kbps	100 m (100 m)	6 m	39 m	250 Kbps	100 m (250 m)	6 m	78 m	125 Kbps	100 m (500 m)	6 m	156 m
Baud rate	Network length (max.)	Drop line length (max.)	Total drop line length (max.)																
500 Kbps	100 m (100 m)	6 m	39 m																
250 Kbps	100 m (250 m)	6 m	78 m																
125 Kbps	100 m (500 m)	6 m	156 m																
<b>Communications power supply</b>		24-VDC DeviceNet power supply																	
<b>Allowable voltage fluctuation range</b>		11 to 25-VDC DeviceNet power supply																	
<b>Current consumption</b>		50 mA max. (24 VDC)																	
<b>Maximum number of nodes</b>		64 (DeviceNet Configurator is counted as one node when connected)																	
<b>Maximum number of slaves</b>		63																	
<b>Error control checks</b>		CRC errors																	
<b>DeviceNet power supply</b>		Supplied from DeviceNet communications connector																	

## Power Supply Derating Curve for Sensor (Reference Value)

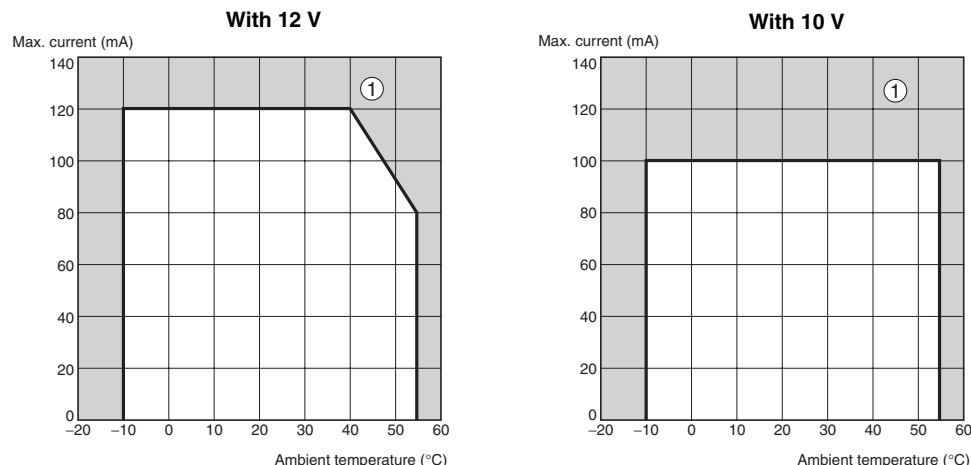

- Note:** 1. The above values are for standard mounting. The derating curve differs depending on the mounting conditions.  
 2. Do not use the Sensor outside of the derating area (i.e., do not use it in the area labeled ① in the above graphics). Doing so may occasionally cause deterioration or damage to internal components.

## Component Names and Functions

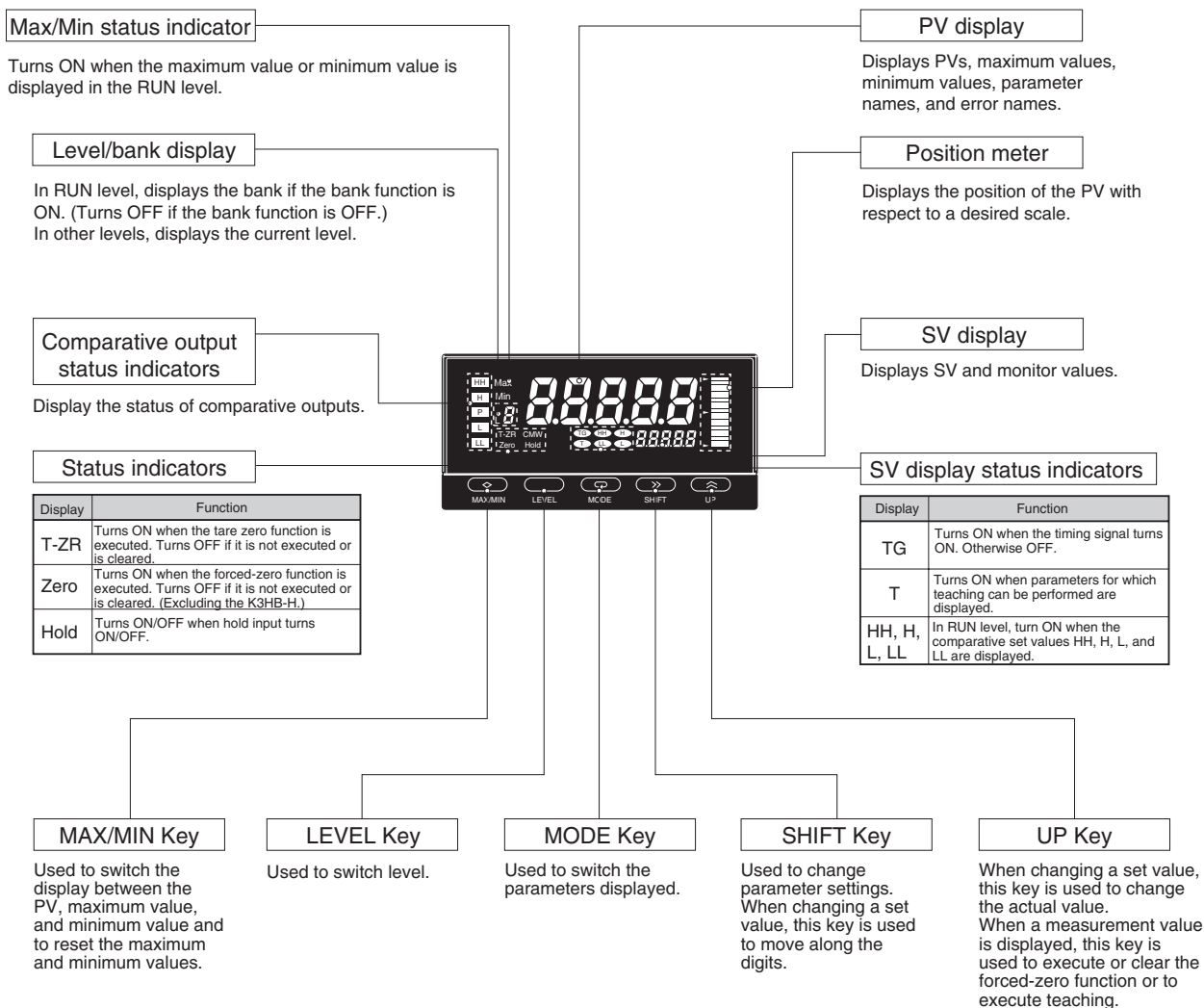

# Connections

## Terminal Arrangement

**Note:** Insulation is used between signal input, event input, output, and power supply terminals.

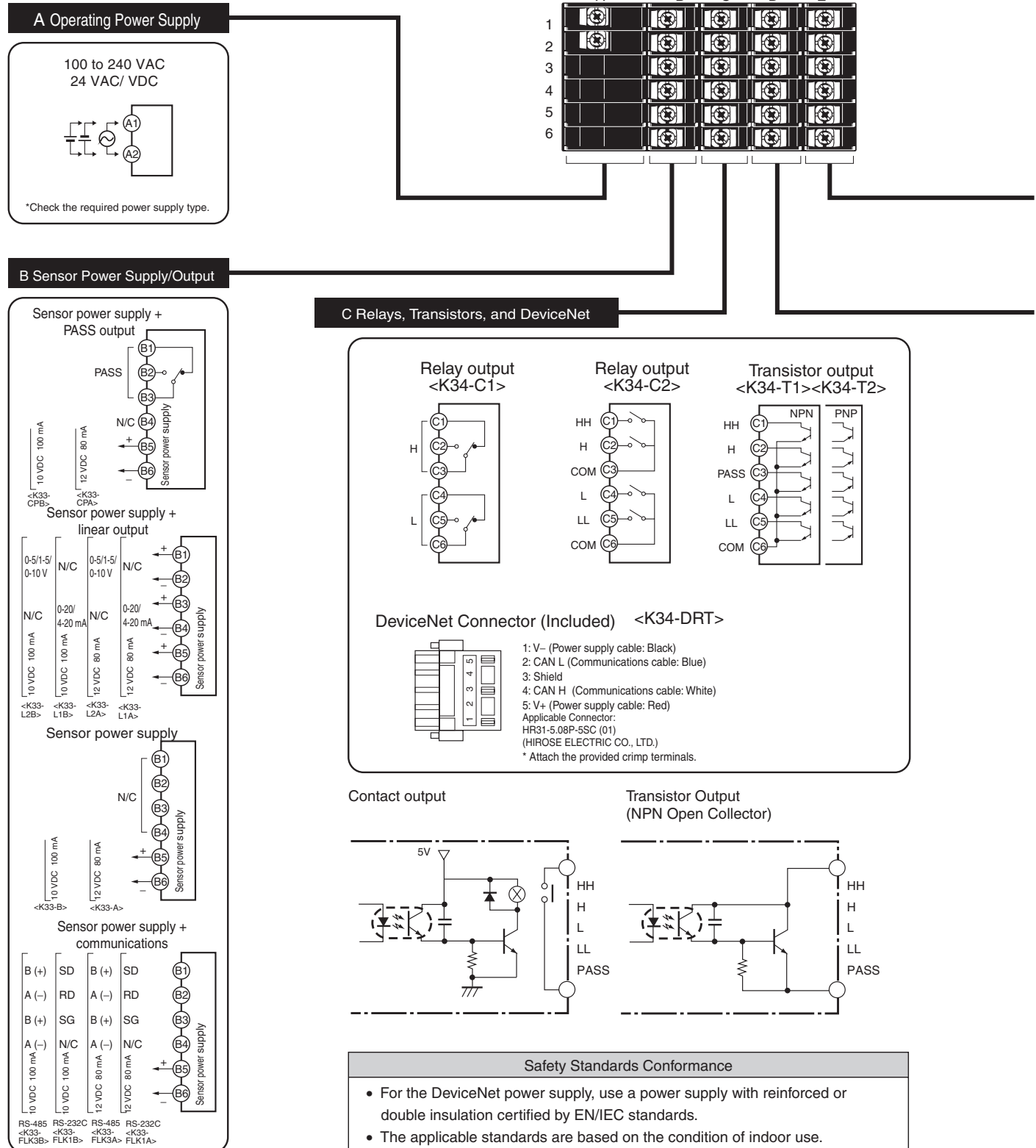

**E Analog Input**

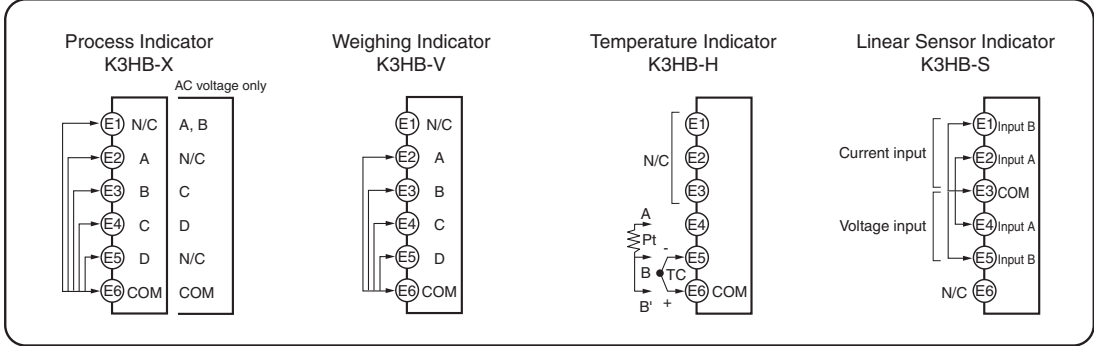

**D Event Input**

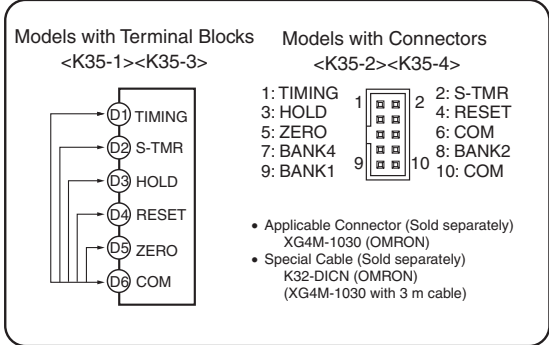

- Use terminal pin D6 as the common terminal.
- Use NPN open collector or no-voltage contacts for event input.  
PNP types are also available.

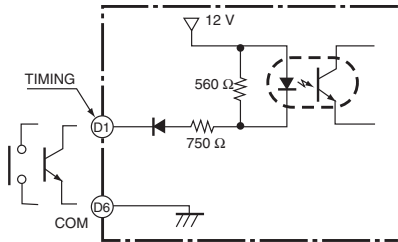
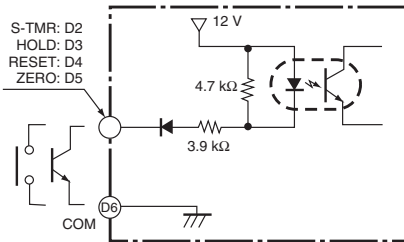

# Main Functions

## Measurement

### Input Calculation **S**

- Two input circuits are provided. The input ranges for these circuits can be set independently. For example, one can be set to 4 to 20 mA and the other can be set to 1 to 5 V.
- In addition to calculations such as K (constant)-A (input for one circuit), it is possible to perform calculations based on the inputs for both circuits, such as A+B and A-B, making it possible to perform thickness measurement and level-difference measurement using displacement and length-measuring sensors.

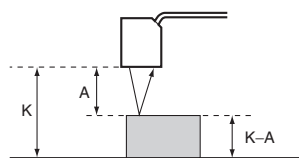

### Timing Hold **X V H S**

#### Normal

- Continuously performs measurement and always outputs based on comparative results.

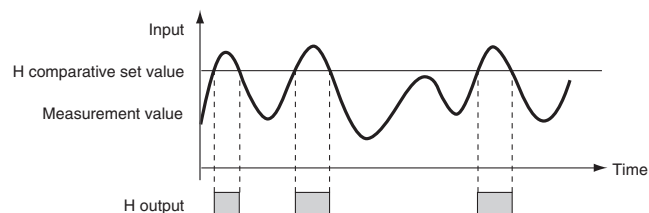

#### Sampling Hold

- Holds the measurement at the rising edge of the TIMING signal.

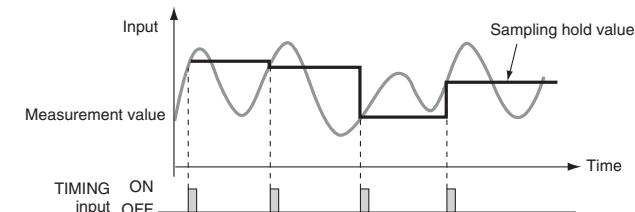

#### Peak Hold/Bottom Hold

- Measures the maximum (or minimum) value in a specified period.

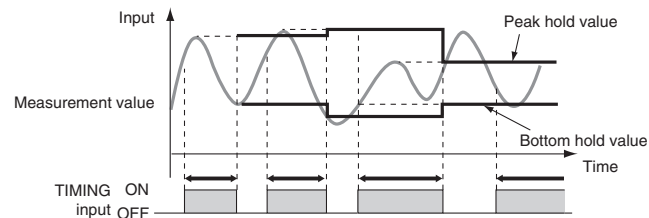

#### Peak-to-peak Hold

- Measures the difference between the maximum and minimum values in a specified period.

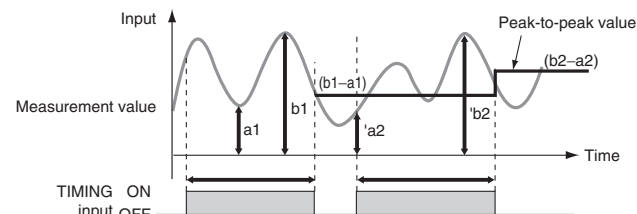

### Scaling **X V S**

Scaling converts input signals in any way required before displaying them. The values can be manipulated by shifting, inverting, or +/- reversing.

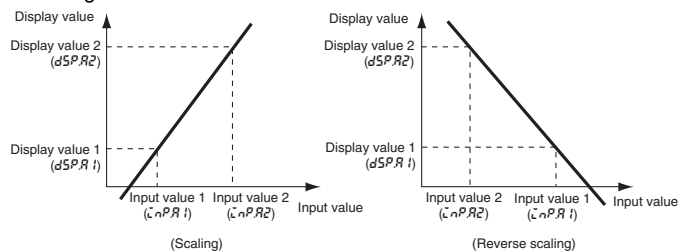

### Average Processing **X V H S**

Average processing of input signals with extreme changes or noise smooths out the display and makes control stable.

### Previous Average Value Comparison **X V H S**

Slight changes can be removed from input signals to detect only extreme changes.

### Temperature Input Shift **H**

Shifts the temperature input value.

### Teaching **X V S**

Settings for scaling can be made using the present measurement values instead of inputting values with the SHIFT and UP Keys. This is a convenient function for making the settings while monitoring the operating status.

### Standby Sequence **X V H S**

Turns the comparative output OFF until the measurement value enters the PASS range.

**Supported Models**

The models that support the functions shown here are indicated by symbols as follows:

- X** K3HB-X
- V** K3HB-V
- H** K3HB-H
- S** K3HB-S

## Input Compensation/Display

### Forced-zero

X V S

Forces the present value to 0. (Convenient for setting reference values or deducting tares for weight measurement.)

### Tare Zero

V S

Shifts the current value measured with a forced zero to 0 again. It is possible to measure two or more compounds separately and then, by releasing the tare zero and forced-zero, measure the combined total.

### Zero-trimming

X V H S

Compensates for mild fluctuations in input signals due to factors such as sensor temperature drift, based on OK (PASS) data at measurement. (This function can be used with sampling hold, peak hold, or bottom hold.)

### Zero-limit

X V H S

Changes the display value to 0 for input values less than the set value. It is enabled in normal mode only. (This function can be used, for example, to stop negative values being displayed or to eliminate flickering and minor inconsistencies near 0.)

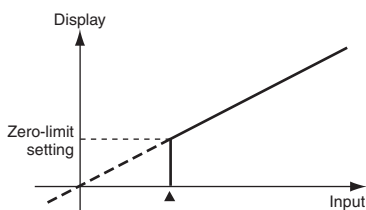

### Display Refresh Period

X V H S

The display refresh period can be lengthened to reduce flickering and thereby make the display easier to read.

### Display Color Selection

X V H S

Values can be displayed in either red or green. With comparative output models, the display color can also be set to change according to the status of comparative outputs (e.g., green to red or red to green).

Example) Setting:  $\overline{G}rrr$

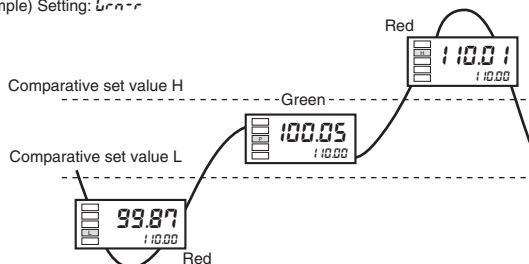

### Display Value Selection

X V H S

The current display value can be selected from the present value, the maximum value, and the minimum value.

### Step Value

X V H S

It is possible to specify (i.e., restrict) the values that the smallest displayed digit can change by. For example, if the setting is 2, the smallest digit will only take the values 0, 2, 4, 6, or 8 and if the setting is 5, it will only take the values 0 or 5. If the setting is 10, it will only take the value of 0.

# Output

## Comparative Output Pattern

X V H S

The output pattern for comparative outputs can be selected. In addition to high/low comparison with set values, output based on level changes is also possible. (Use the type of output pattern appropriate for the application.)

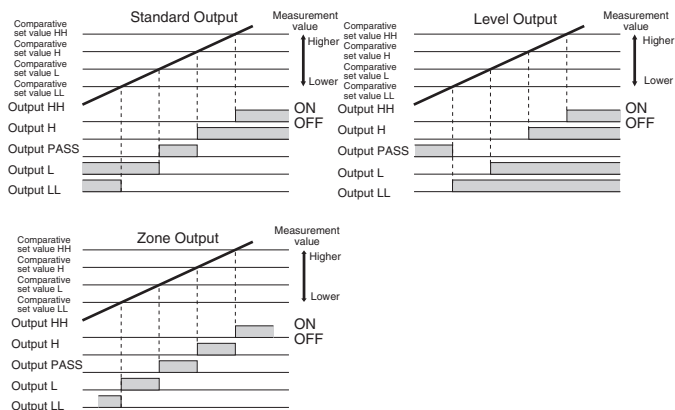

## Output Logic

X V H S

Reverses the output operation of comparative outputs for comparative results.

## Hysteresis

X V H S

Prevents comparative output chattering when the measurement value fluctuates slightly near the set value.

Example: Comparative Output Pattern (Standard Output)

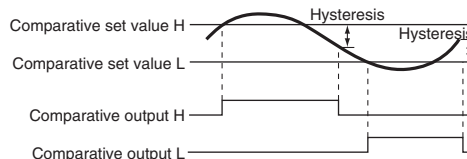

## Startup Compensation Timer

X V H S

Measurement can be stopped for a set time using external input.

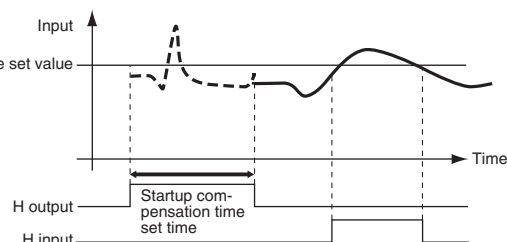

## PASS Output Change

X V H S

Comparative results other than PASS and error signals can be output from the PASS output terminal.

# Dimensions

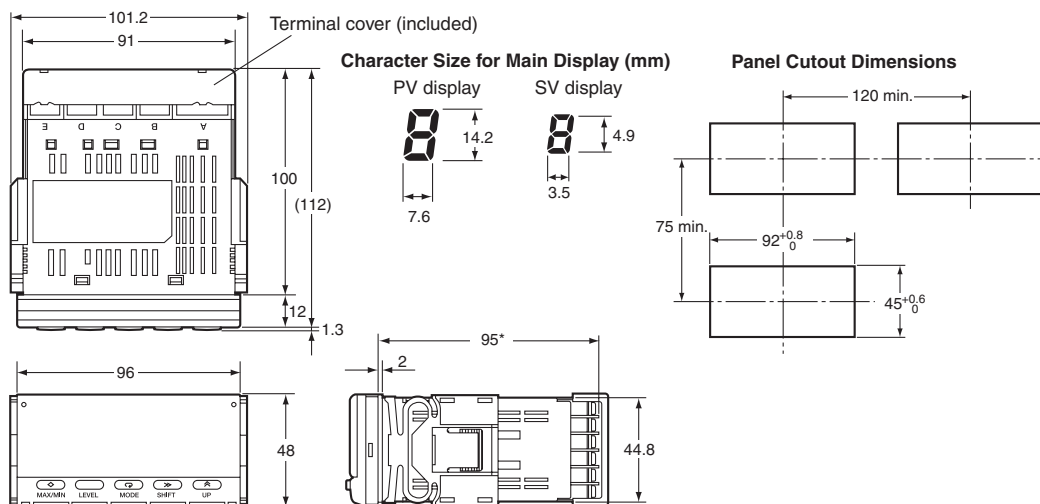

\*DeviceNet models: 97 mm  
Terminal: M3, Terminal Cover: Accessory

## ■ Wiring Precautions

- For terminal blocks, use the crimp terminals suitable for M3 screws.
- Tighten the terminal screws to the recommended tightening torque of approx. 0.5 N·m.
- To prevent inductive noise, separate the wiring for signal lines from that for power lines.

## Wiring

- Use the crimp terminals suitable for M3 screws shown below.

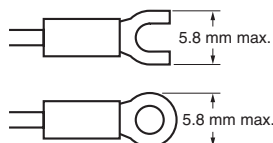

## Unit Stickers

- Select the appropriate units from the unit sticker sheets provided and attach the sticker to the Indicator.

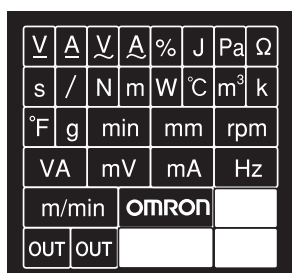

**Note:** When using for meters, such as weighing meters, use the units specified by regulations on weights and measures.

## ■ Mounting Method

1. Insert the K3HB into the mounting cutout in the panel.
2. Insert watertight packing around the Unit to make the mounting watertight.

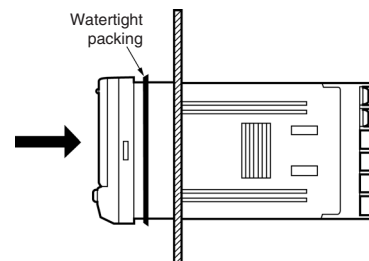

3. Insert the adapter into the grooves on the left and right sides of the rear case and push until it reaches the panel and is fixed in place.

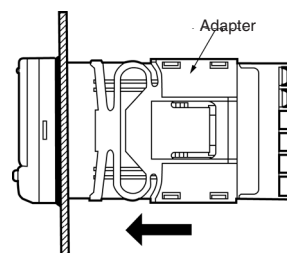

## ■ LCD Field of Vision

The K3HB is designed to have the best visibility at the angles shown in the following diagram.

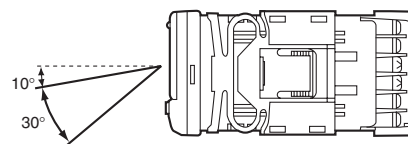

## ■ Waterproof Packing

The waterproof packing ensures a level of waterproofing that conforms to NEMA 4X. Depending on the operating environment, deterioration, contraction, or hardening may occur and replacement may be necessary. In this case, consult your OMRON representative.



## ■ Precautions

### WARNING

Do not touch the terminals while power is being supplied. Doing so may possibly result in electric shock. Make sure that the terminal cover is installed before using the product.



Always provide protective circuits in the network. Without protective circuits, malfunctions may possibly result in accidents that cause serious injury or significant property damage.



Provide double or triple safety measures in external control circuits, such as emergency stop circuits, interlock circuits, or limit circuits, to ensure safety in the system if an abnormality occurs due to malfunction of the product or another external factor affecting the product's operation.

### CAUTION

Do not allow pieces of metal, wire clippings, or fine metallic shavings or filings from installation to enter the product. Doing so may occasionally result in minor electric shock, fire, or malfunction.



Do not use the product in locations where flammable or explosive gases are present. Doing so may occasionally result in explosion, causing minor or moderate injury, or property damage.



Do not use the equipment for measurements within Measurement Categories III and IV for K3HB-X and II, III, and IV for K3HB-S, K3HB-V, and K3HB-H (according to IEC61010-1). Doing so may occasionally cause unexpected operation, resulting in minor or moderate injury, or damage to the equipment. Use the equipment for measurements only within the Measurement Category for which the product is designed.



Perform correct setting of the product according to the application. Failure to do so may occasionally cause unexpected operation, resulting in minor or moderate injury, or damage to the equipment.



Ensure safety in the event of product failure by taking safety measures, such as installing a separate monitoring system. Product failure may occasionally prevent operation of comparative outputs, resulting in damage to the connected facilities and equipment.



Tighten the screws on the terminal block and the connector locking screws securely using a tightening torque within the following ranges. Loose screws may occasionally cause fire, resulting in minor or moderate injury, or damage to the equipment.



Terminal block screws: 0.43 to 0.58 N·m

Connector locking screws: 0.18 to 0.22 N·m

Make sure that the product will not be adversely affected if the DeviceNet cycle time is lengthened as a result of changing the program with online editing. Extending the cycle time may cause unexpected operation, occasionally resulting in minor or moderate injury, or damage to the equipment.



Before transferring programs to other nodes or changing I/O memory of other nodes, check the nodes to confirm safety. Changing the program or I/O memory of other nodes may occasionally cause unexpected operation, resulting in minor or moderate injury, or damage to the equipment.



Do not attempt to disassemble, repair, or modify the product. Doing so may occasionally result in minor or moderate injury due to electric shock.



## Precautions for Safe Use

- Do not use the product in the following locations.
  - Locations subject to direct radiant heat from heating equipment
  - Locations where the product may come into contact with water or oil
  - Locations subject to direct sunlight
  - Locations where dust or corrosive gases (in particular, sulfuric or ammonia gas) are present
  - Locations subject to extreme temperature changes
  - Locations where icing or condensation may occur
  - Locations subject to excessive shocks or vibration
- Do not use the product in locations subject to temperatures or humidity levels outside the specified ranges or in locations prone to condensation. If the product is installed in a panel, ensure that the temperature around the product (not the temperature around the panel) does not go outside the specified range.
- Provide sufficient space around the product for heat dissipation.
- Use and store the product within the specified temperature and humidity ranges. If several products are mounted side-by-side or arranged in a vertical line, the heat dissipation will cause the internal temperature of the products to rise, shortening the service life. If necessary, cool the products using a fan or other cooling method.
- The service life of the output relays depends on the switching capacity and switching conditions. Consider the actual application conditions and use the product within the rated load and electrical service life. Using the product beyond its service life may result in contact welding or burning.
- Install the product horizontally.
- Mount to a panel between 1 and 8-mm thick.
- Use the specified size of crimp terminals (M3, width: 5.8 mm max.) for wiring. To connect bare wires, use AWG22 (cross section: 0.326 mm<sup>2</sup>) to AWG14 (cross section: 2.081 mm<sup>2</sup>) to wire the power supply terminals and AWG28 (cross section: 0.081 mm<sup>2</sup>) to AWG16 (cross section: 1.309 mm<sup>2</sup>) for other terminals. (Length of exposed wire: 6 to 8 mm)
- In order to prevent inductive noise, wire the lines connected to the product separately from power lines carrying high voltages or currents. Do not wire in parallel with or in the same cable as power lines. Other measures for reducing noise include running lines along separate ducts and using shield lines.
- Ensure that the rated voltage is achieved no longer than 2 s after turning the power ON.
- Allow the product to operate without load for at least 15 minutes after the power is turned ON.
- Do not install the product near devices generating strong high-frequency waves or surges. When using a noise filter, check the voltage and current and install it as close to the product as possible.
- Do not use thinner to clean the product. Use commercially available alcohol.
- Be sure to confirm the name and polarity for each terminal before wiring the terminal block and connectors.
- Use the product within the noted supply voltage and rated load.
- Do not connect anything to unused terminals.
- Output turns OFF when the mode is changed or settings are initialized. Take this into consideration when setting up the control system.
- Install an external switch or circuit breaker that complies with applicable IEC60947-1 and IEC60947-3 requirements and label them clearly so that the operator can quickly turn OFF the power.
- Use the specified cables for the communications lines and stay within the specified DeviceNet communications distances. Refer to the User's Manual (Cat. No. N129) for details on communications distance specifications and cables.
- Do not pull the DeviceNet communications cables with excessive force or bend them past their natural bending radius.

- 21. Do not connect or remove connectors while the DeviceNet power is being supplied. Doing so will cause product failure or malfunction.
- 22. Use cables with a heat resistance of 70°C min.

## ■ Noise Countermeasures

- 1. Do not install the product near devices generating strong high-frequency waves or surges, such as high-frequency welding and sewing machines.
- 2. Mount a surge suppressor or noise filter to peripheral devices generating noise, in particular, motors, transformers, solenoids, and magnet coils.

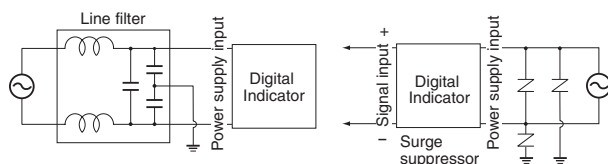

- 3. In order to prevent inductive noise, wire the lines connected to the terminal block separately from power lines carrying high voltages or currents. Do not wire in parallel with or in the same cable as power lines. Other measures for reducing noise include running lines along separate ducts and using shield lines.

### Example of Countermeasures for Inductive Noise on Input Lines

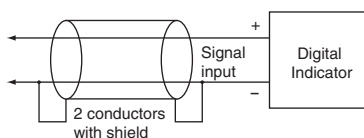

- 4. If a noise filter is used for the power supply, check the voltage and current, and install the noise filter as close to the product as possible.
- 5. Reception interference may occur if the product is used close to a radio, television, or wireless.

## Certain Terms and Conditions of Sale

1. **Offer; Acceptance.** These terms and conditions (these "Terms") are deemed part of all catalogs, manuals or other documents, whether electronic or in writing, relating to the sale of goods or services (collectively, the "Goods") by Omron Electronics LLC and its subsidiary companies ("Seller"). Seller hereby objects to any terms or conditions proposed in Buyer's purchase order or other documents which are inconsistent with, or in addition to, these Terms. Please contact your Omron representative to confirm any additional terms for sales from your Omron company.
2. **Prices.** All prices stated are current, subject to change without notice by Seller. Buyer agrees to pay the price in effect at time of shipment.
3. **Discounts.** Cash discounts, if any, will apply only on the net amount of invoices sent to Buyer after deducting transportation charges, taxes and duties, and will be allowed only if (i) the invoice is paid according to Seller's payment terms and (ii) Buyer has no past due amounts owing to Seller.
4. **Orders.** Seller will accept no order less than \$200 net billing.
5. **Governmental Approvals.** Buyer shall be responsible for, and shall bear all costs involved in, obtaining any government approvals required for the importation or sale of the Goods.
6. **Taxes.** All taxes, duties and other governmental charges (other than general real property and income taxes), including any interest or penalties thereon, imposed directly or indirectly on Seller or required to be collected directly or indirectly by Seller for the manufacture, production, sale, delivery, importation, consumption or use of the Goods sold hereunder (including customs duties and sales, excise, use, turnover and license taxes) shall be charged to and remitted by Buyer to Seller.
7. **Financial.** If the financial position of Buyer at any time becomes unsatisfactory to Seller, Seller reserves the right to stop shipments or require satisfactory security or payment in advance. If Buyer fails to make payment or otherwise comply with these Terms or any related agreement, Seller may (without liability and in addition to other remedies) cancel any unshipped portion of Goods sold hereunder and stop any Goods in transit until Buyer pays all amounts, including amounts payable hereunder, whether or not then due, which are owing to it by Buyer. Buyer shall in any event remain liable for all unpaid accounts.
8. **Cancellation; Etc.** Orders are not subject to rescheduling or cancellation unless Buyer indemnifies Seller fully against all costs or expenses arising in connection therewith.
9. **Force Majeure.** Seller shall not be liable for any delay or failure in delivery resulting from causes beyond its control, including earthquakes, fires, floods, strikes or other labor disputes, shortage of labor or materials, accidents to machinery, acts of sabotage, riots, delay in or lack of transportation or the requirements of any government authority.
10. **Shipping; Delivery.** Unless otherwise expressly agreed in writing by Seller:
  - a. Shipments shall be by a carrier selected by Seller;
  - b. Such carrier shall act as the agent of Buyer and delivery to such carrier shall constitute delivery to Buyer;
  - c. All sales and shipments of Goods shall be FOB shipping point (unless otherwise stated in writing by Seller), at which point title to and all risk of loss of the Goods shall pass from Seller to Buyer, provided that Seller shall retain a security interest in the Goods until the full purchase price is paid by Buyer;
  - d. Delivery and shipping dates are estimates only.
  - e. Seller will package Goods as it deems proper for protection against normal handling and extra charges apply to special conditions.
11. **Claims.** Any claim by Buyer against Seller for shortage or damage to the Goods occurring before delivery to the carrier must be presented in writing to Seller within 30 days of receipt of shipment and include the original transportation bill signed by the carrier noting that the carrier received the Goods from Seller in the condition claimed.
12. **Warranties.** (a) **Exclusive Warranty.** Seller's exclusive warranty is that the Goods will be free from defects in materials and workmanship for a period of twelve months from the date of sale by Seller (or such other period expressed in writing by Seller). Seller disclaims all other warranties, express or implied. (b) **Limitations.** SELLER MAKES NO WARRANTY OR REPRESENTATION, EXPRESS OR IMPLIED, ABOUT NON-INFRINGEMENT, MERCHANTABILITY OR FITNESS FOR A PARTICULAR PURPOSE OF THE GOODS. BUYER ACKNOWLEDGES THAT IT ALONE HAS DETERMINED THAT THE GOODS WILL SUITABLY MEET THE REQUIREMENTS OF THEIR INTENDED USE. Seller further disclaims all warranties and responsibility of any type for claims or expenses based on infringement by the Goods or otherwise of any intellectual property right. (c) **Buyer Remedy.** Seller's sole obligation hereunder shall be to replace (in the form originally shipped with Buyer responsible for labor charges for removal or replacement thereof) the non-complying Good or, at Seller's election, to repay or credit Buyer an amount equal to the purchase price of the Good; provided that in no event shall Seller be responsible for warranty, repair, indemnity or any other claims or expenses regarding the Goods unless Seller's analysis confirms that the Goods were properly handled, stored, installed and maintained and not subject to contamination, abuse, misuse or inappropriate modification. Return of any goods by Buyer must be approved in writing by Seller before shipment. Seller shall not be liable for the suitability or unsuitability or the results from the use of Goods in combination with any electrical or electronic components, circuits, system assemblies or any other materials or substances or environments. Any advice, recommendations or information given orally or in writing, are not to be construed as an amendment or addition to the above warranty.
13. **Damage Limits; Etc.** SELLER SHALL NOT BE LIABLE FOR SPECIAL, INDIRECT OR CONSEQUENTIAL DAMAGES, LOSS OF PROFITS OR PRODUCTION OR COMMERCIAL LOSS IN ANY WAY CONNECTED WITH THE GOODS, WHETHER SUCH CLAIM IS BASED IN CONTRACT, WARRANTY, NEGLIGENCE OR STRICT LIABILITY. Further, in no event shall liability of Seller exceed the individual price of the Good on which liability is asserted.
14. **Indemnities.** Buyer shall indemnify and hold harmless Seller, its affiliates and its employees from and against all liabilities, losses, claims, costs and expenses (including attorney's fees and expenses) related to any claim, investigation, litigation or proceeding (whether or not Seller is a party) which arises or is alleged to arise from Buyer's acts or omissions under these Terms or in any way with respect to the Goods. Without limiting the foregoing, Buyer (at its own expense) shall indemnify and hold harmless Seller and defend or settle any action brought against Seller to the extent that it is based on a claim that any Good made to Buyer specifications infringed intellectual property rights of another party.
15. **Property; Confidentiality.** The intellectual property embodied in the Goods is the exclusive property of Seller and its affiliates and Buyer shall not attempt to duplicate it in any way without the written permission of Seller. Notwithstanding any charges to Buyer for engineering or tooling, all engineering and tooling shall remain the exclusive property of Seller. All information and materials supplied by Seller to Buyer relating to the Goods are confidential and proprietary, and Buyer shall limit distribution thereof to its trusted employees and strictly prevent disclosure to any third party.
16. **Miscellaneous.** (a) **Waiver.** No failure or delay by Seller in exercising any right and no course of dealing between Buyer and Seller shall operate as a waiver of rights by Seller. (b) **Assignment.** Buyer may not assign its rights hereunder without Seller's written consent. (c) **Amendment.** These Terms constitute the entire agreement between Buyer and Seller relating to the Goods, and no provision may be changed or waived unless in writing signed by the parties. (d) **Severability.** If any provision hereof is rendered ineffective or invalid, such provision shall not invalidate any other provision. (e) **Setoff.** Buyer shall have no right to set off any amounts against the amount owing in respect of this invoice. (f) As used herein, "including" means "including without limitation".

## Certain Precautions on Specifications and Use

1. **Suitability of Use.** Seller shall not be responsible for conformity with any standards, codes or regulations which apply to the combination of the Good in the Buyer's application or use of the Good. At Buyer's request, Seller will provide applicable third party certification documents identifying ratings and limitations of use which apply to the Good. This information by itself is not sufficient for a complete determination of the suitability of the Good in combination with the end product, machine, system, or other application or use. The following are some examples of applications for which particular attention must be given. This is not intended to be an exhaustive list of all possible uses of this Good, nor is it intended to imply that the uses listed may be suitable for this Good:
  - (i) Outdoor use, uses involving potential chemical contamination or electrical interference, or conditions or uses not described in this document.
  - (ii) Energy control systems, combustion systems, railroad systems, aviation systems, medical equipment, amusement machines, vehicles, safety equipment, and installations subject to separate industry or government regulations.
  - (iii) Systems, machines and equipment that could present a risk to life or property. Please know and observe all prohibitions of use applicable to this Good.
2. **Programmable Products.** Seller shall not be responsible for the user's programming of a programmable Good, or any consequence thereof.
3. **Performance Data.** Performance data given in this catalog is provided as a guide for the user in determining suitability and does not constitute a warranty. It may represent the result of Seller's test conditions, and the user must correlate it to actual application requirements. Actual performance is subject to the Seller's Warranty and Limitations of Liability.
4. **Change in Specifications.** Product specifications and accessories may be changed at any time based on improvements and other reasons. It is our practice to change part numbers when published ratings or features are changed, or when significant construction changes are made. However, some specifications of the Good may be changed without any notice. When in doubt, special part numbers may be assigned to fix or establish key specifications for your application. Please consult with your Seller's representative at any time to confirm actual specifications of purchased Good.
5. **Errors and Omissions.** The information in this catalog has been carefully checked and is believed to be accurate; however, no responsibility is assumed for clerical, typographical or proofreading errors, or omissions.

NEVER USE THE PRODUCT FOR AN APPLICATION INVOLVING SERIOUS RISK TO LIFE OR PROPERTY WITHOUT ENSURING THAT THE SYSTEM AS A WHOLE HAS BEEN DESIGNED TO ADDRESS THE RISKS, AND THAT THE SELLER'S PRODUCT IS PROPERLY RATED AND INSTALLED FOR THE INTENDED USE WITHIN THE OVERALL EQUIPMENT OR SYSTEM.

Complete "Terms and Conditions of Sale" for product purchase and use are on Omron's website at [www.omron.com/oei](http://www.omron.com/oei) – under the "About Us" tab, in the Legal Matters section.

**ALL DIMENSIONS SHOWN ARE IN MILLIMETERS.**

To convert millimeters into inches, multiply by 0.03937. To convert grams into ounces, multiply by 0.03527.

---

**OMRON**<sup>®</sup>**OMRON ELECTRONICS LLC**

One Commerce Drive  
Schaumburg, IL 60173

**847-843-7900**

For US technical support or other inquiries:

**800-556-6766****OMRON CANADA, INC.**

885 Milner Avenue  
Toronto, Ontario M1B 5V8

**416-286-6465****OMRON ON-LINE**

Global - <http://www.omron.com>  
USA - <http://www.omron.com/oei>  
Canada - <http://www.omron.ca>