

**Ordering number CA11016\_TINA2-RS**

Family	Tina2	FWHM	16 degrees
Type	Assembly	Efficiency	91 %
LED	3535 Ceramic (LEMWA33)	3W cd/lm	8.000
Color	Black	Gerber File	Available
Diameter	16.1 mm		
Height	9.7 mm		
Style	Round		
Optic Material	PMMA		
Holder Material	PC		
Fastening	Tape		
Status	Ready		

**Ordering number CA11017\_TINA2-M**

Family	Tina2	FWHM	30 degrees
Type	Assembly	Efficiency	85 %
LED	3535 Ceramic (LEMWA33)	3W cd/lm	2.550
Color	Black	Gerber File	Available
Diameter	16.1 mm		
Height	9.7 mm		
Style	Round		
Optic Material	PMMA		
Holder Material	PC		
Fastening	Tape		
Status	Ready		

**Ordering number CA11052\_TINA2-O**

Family	Tina2	FWHM	33+17 degrees
Type	Assembly	Efficiency	86 %
LED	3535 Ceramic (LEMWA33)	3W cd/lm	3.500
Color	Black	Gerber File	Available
Diameter	16.1 mm		
Height	9.7 mm		
Style	Round		
Optic Material	PMMA		
Holder Material	PC		
Fastening	Tape		
Status	Ready		

**NOTE: The typical divergence will be changed by different color, chip size and chip position tolerance. The typical total divergence is the full angle measured where the luminous intensity is half of the peak value.**



## PRODUCT DATASHEET Tina2 series

last update 28/1/2013

### GENERAL INFORMATION

- Product series especially designed & optimized for 3535 Ceramic 3W (LEMWA33) series of LEDs.
- Special care taken to make light distribution as uniform as possible.
- Lens material optical grade PMMA with high UV and temperature resistance. Allows use of high current and temperature conditions.

Please find more information about used material from below:

[http://ledil.fi/sites/default/files/Documents/Technical/Material/PMMA%20N%20UL94\\_Yellow%20Card.pdf](http://ledil.fi/sites/default/files/Documents/Technical/Material/PMMA%20N%20UL94_Yellow%20Card.pdf)

<http://ledil.fi/sites/default/files/Documents/Technical/Material/PMMA%20N%20PLEXIGLAS-Datasheet.pdf>

- Optic holder molded by high quality PC material (120 degrees of Celcius / 248 degrees of Fahrenheit).

- Fastening to heat sink with a PU foam adhesive tape of automotive grade. Please find fastening details by clicking link: [http://www.ledil.com/datasheets/DataSheet\\_TAPE.pdf](http://www.ledil.com/datasheets/DataSheet_TAPE.pdf)

**NOTE 1: We advise customer to ensure the suitability and sufficiency of the bond in the end product. For example, mechanical stress, vibration and holes on the surface of the circuit board weaken the strength of the tape.**

**NOTE 2: Assembly to the surface must be made straight, so the tape bonds constant and balanced with fastening surface. Slanted assembly might cause unbalanced bond to the surface. All surfaces where tape is applied must be clean, dry and free from grease and dirt.**

**If cleaning of PCB surfaces is needed, please follow strictly the cleaning instructions of your LED manufacturer - this is important as cleaning shall under no circumstances damage LEDs or other electronics components on the PCB.**

**Further note that optical components shall not be cleaned with any chemicals - only micro fiber cloth may be used to remove fingerprints or other traces from handling.**

Relative intensity of CA11052\_Tina2-Z5-O

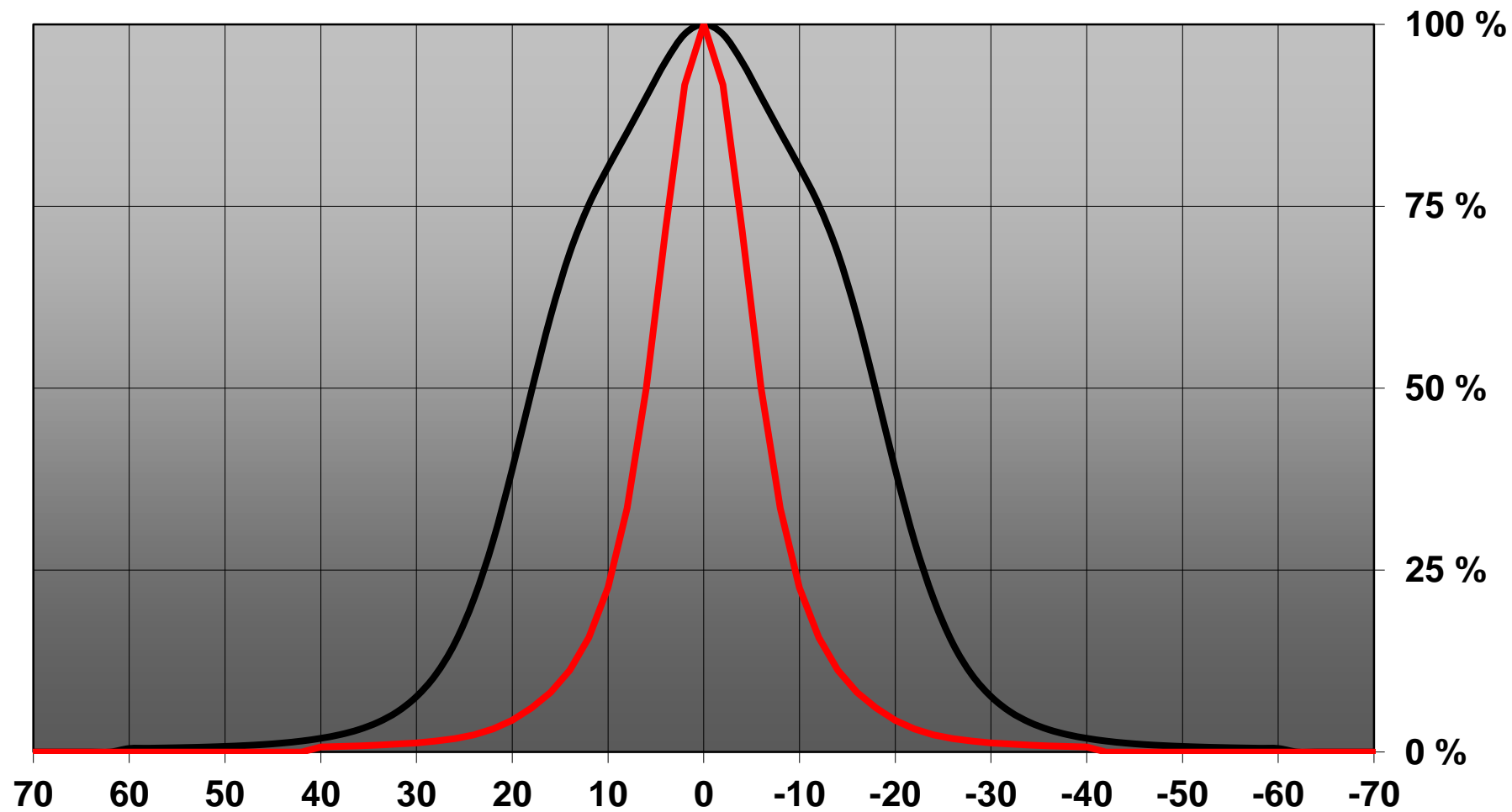

D C B A

4

Oval beam direction

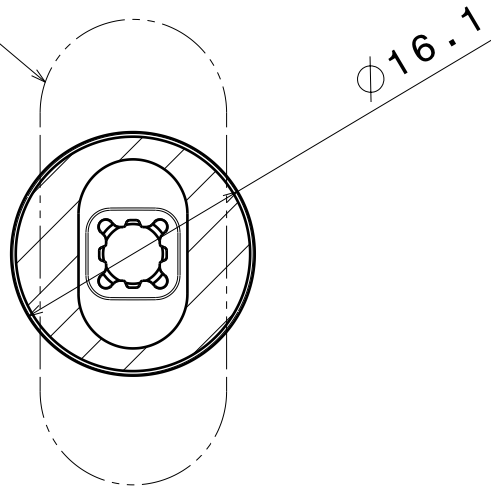

4

3

Lens

Holder

Tape

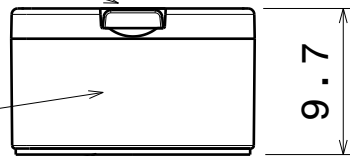

3

2

**MATERIALS**

Lens: PMMA  
 Holder: PC  
 Tape: PU Foam with PSA

**Part no.s:**

CA11016\_Tina2-XP-RS  
 CA11017\_Tina2-XP-M  
 CA11052\_Tina2-XP-O  
 CA11420\_Tina2-XP-D

2

1

This drawing is our property.  
 It can't be reproduced  
 or communicated without  
 our written agreement.



L  
T  
F  
F

e  
e  
i  
i  
N  
n

d

**DRAWING TITLE**

Datasheet Tina2-XP Tape series

1

**DRAWN BY**

p

**DATE**

v20.3.2012

**CHECKED BY**

s

n

**DATE**

28.07.2010

**SIZE**

A4

**DRAWING NUMBER**

-

**REV**

3

**DESIGNED BY**

HH

**DATE**

09.11.2009

**SCALE**

2:1

**WEIGHT (g)**

-

**SHEET**

1/1

D

A

# LEDiL Oy CA11016\_TINA2-RS\_(3535\_Ceramic)\_2 Eff.90.7% / LDC (Linear)

Luminaire: LEDiL Oy CA11016\_TINA2-RS\_(3535\_Ceramic)\_2 Eff.90.7%

Lamps: 1 x LG 3535 Ceramic (95lm@250mA)

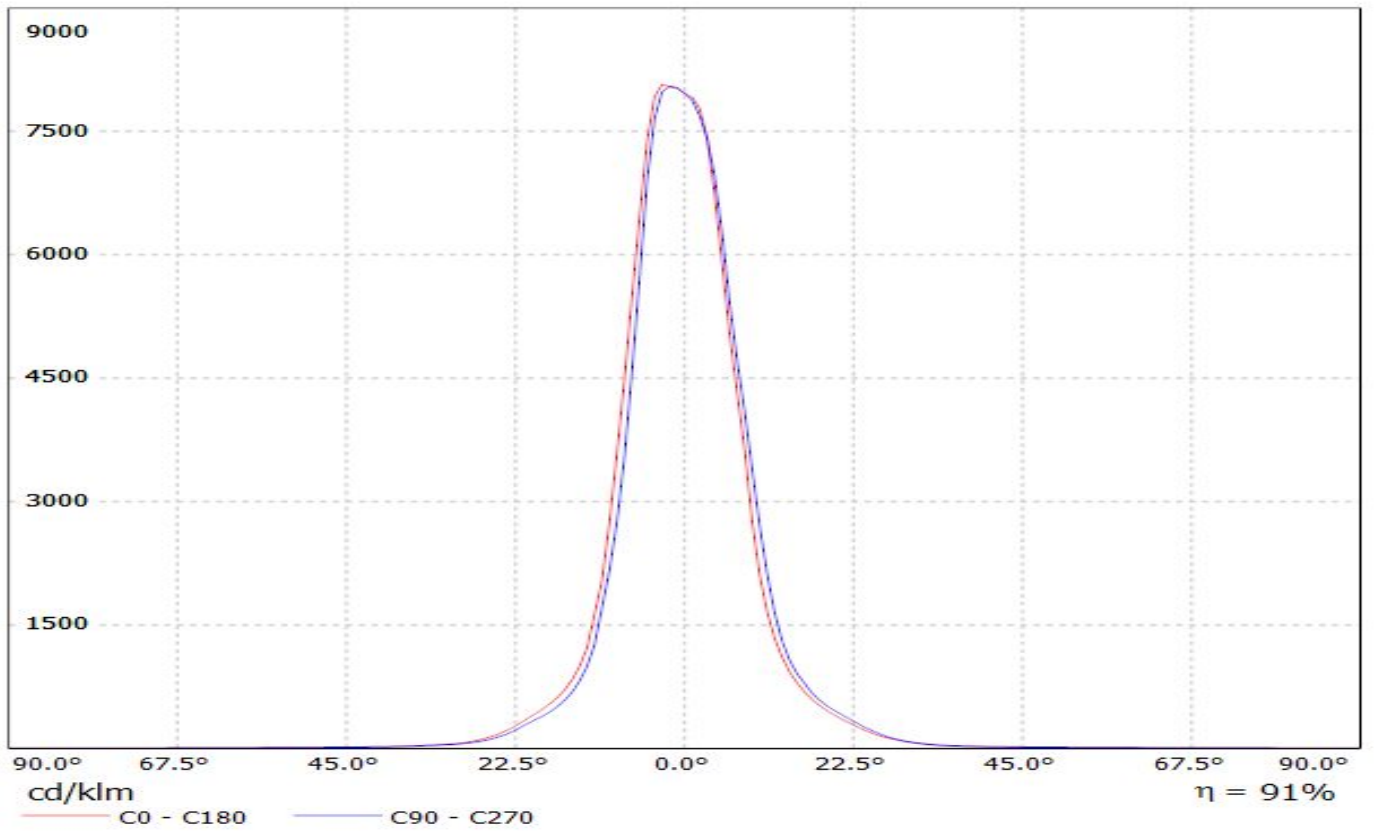

**LEDiL Oy CA11017\_TINA2-M\_(3535\_Ceramic)\_1 Eff.84.1% / LDC (Linear)**

Luminaire: LEDiL Oy CA11017\_TINA2-M\_(3535\_Ceramic)\_1 Eff.84.1%  
Lamps: 1 x LG 3535 Ceramic (95lm@250mA)

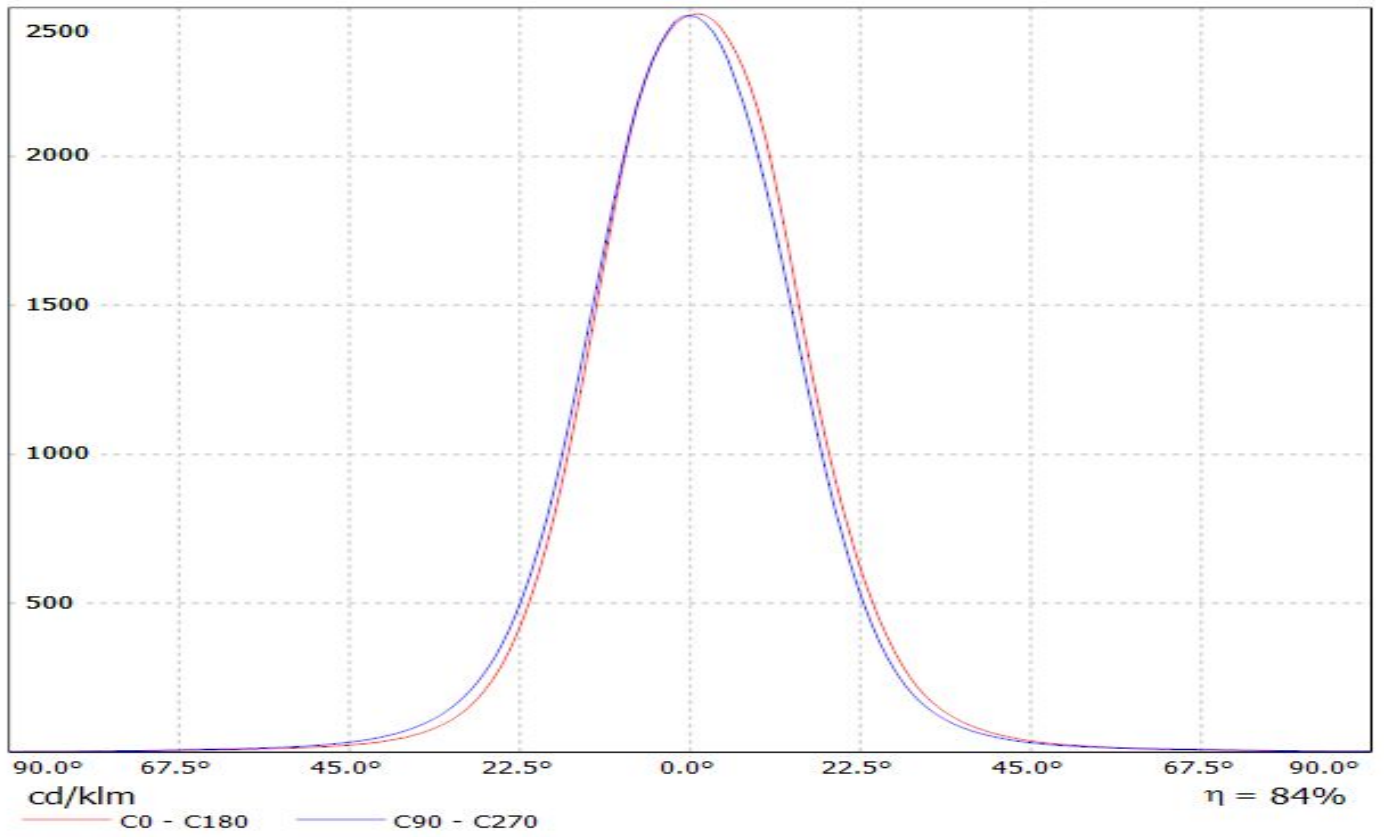

# LEDiL Oy CA11052\_TINA2-O\_(3535\_Ceramic)\_2 Eff.85.5% / LDC (Linear)

Luminaire: LEDiL Oy CA11052\_TINA2-O\_(3535\_Ceramic)\_2 Eff.85.5%

Lamps: 1 x LG 3535 Ceramic (95lm@250mA)

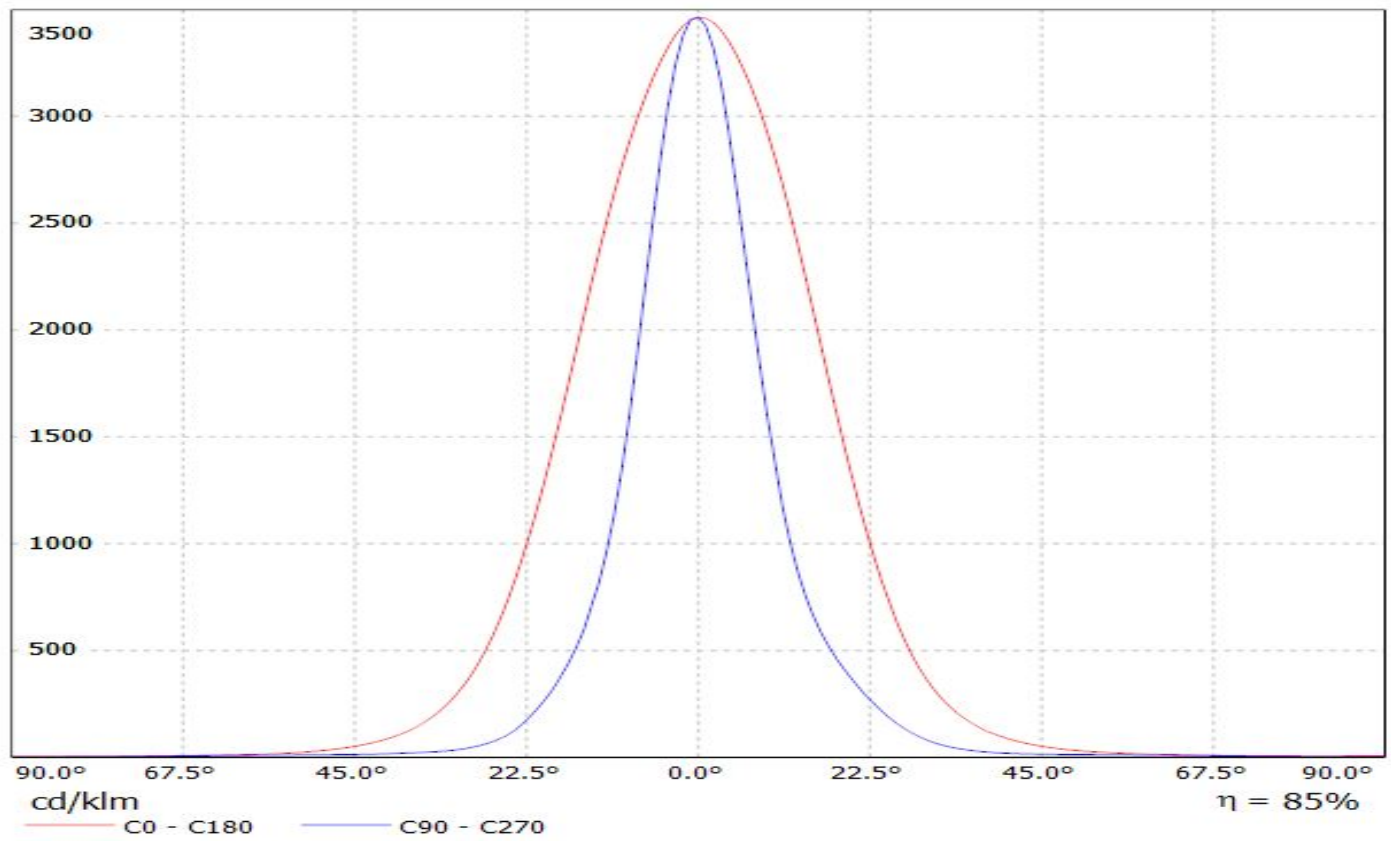

# LEDiL Oy CA11016\_TINA2-RS\_(3535\_Ceramic)\_2 Eff.90.7% / LDC (Polar)

Luminaire: LEDiL Oy CA11016\_TINA2-RS\_(3535\_Ceramic)\_2 Eff.90.7%

Lamps: 1 x LG 3535 Ceramic (95lm@250mA)

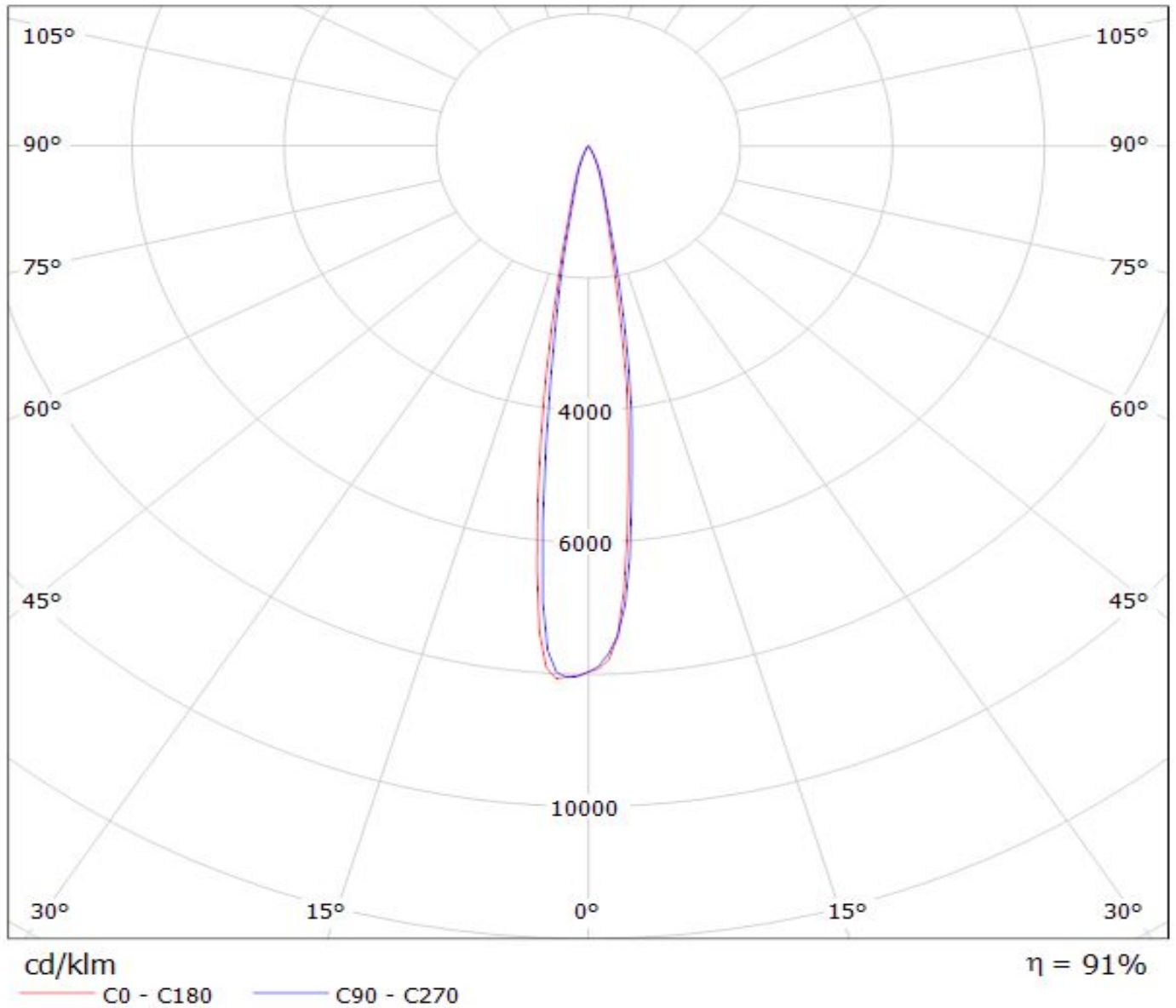



# LEDiL Oy CA11017\_TINA2-M\_(3535\_Ceramic)\_1 Eff.84.1% / LDC (Polar)

Luminaire: LEDiL Oy CA11017\_TINA2-M\_(3535\_Ceramic)\_1 Eff.84.1%

Lamps: 1 x LG 3535 Ceramic (95lm@250mA)

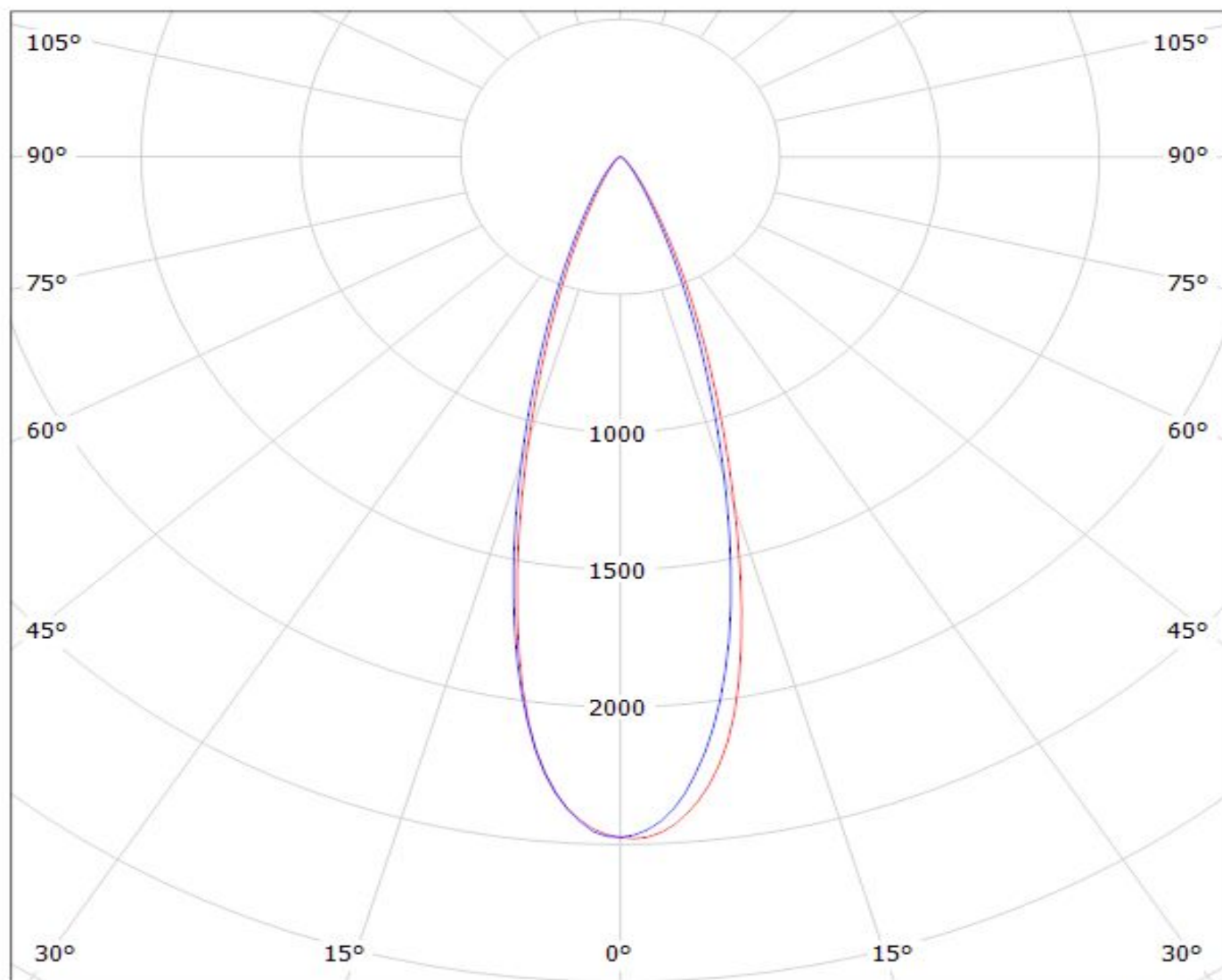

cd/klm

— C0 - C180

— C90 - C270

$\eta = 84\%$

# LEDiL Oy CA11052\_TINA2-O\_(3535\_Ceramic)\_2 Eff.85.5% / LDC (Polar)

Luminaire: LEDiL Oy CA11052\_TINA2-O\_(3535\_Ceramic)\_2 Eff.85.5%

Lamps: 1 x LG 3535 Ceramic (95lm@250mA)

