

Time Delay Values (A, B, C & D-Series)

AC

DC

Instantaneous

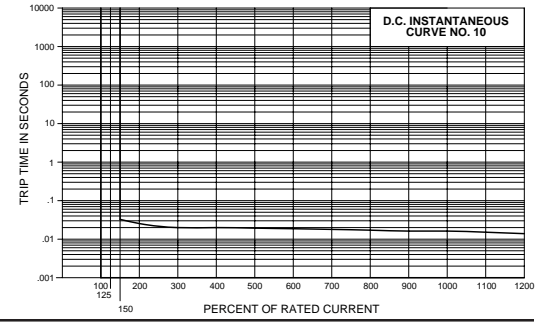
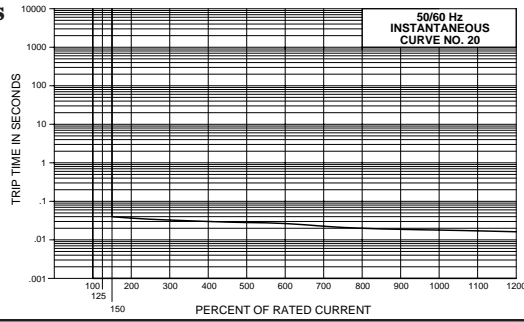

Ultrashort

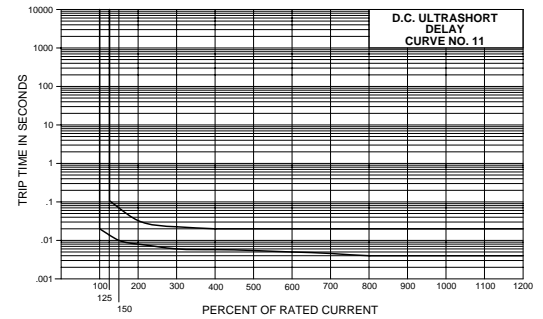
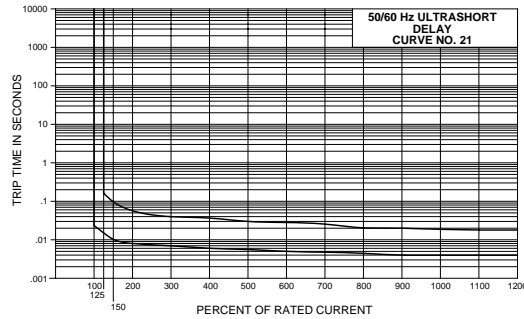

Short

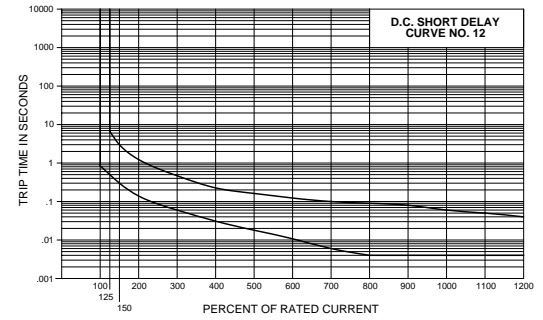
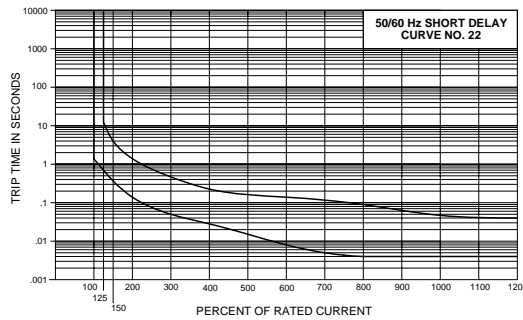

Medium

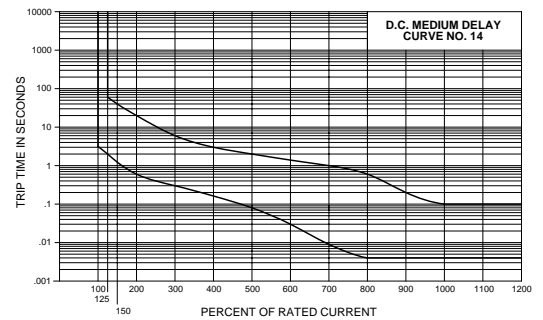
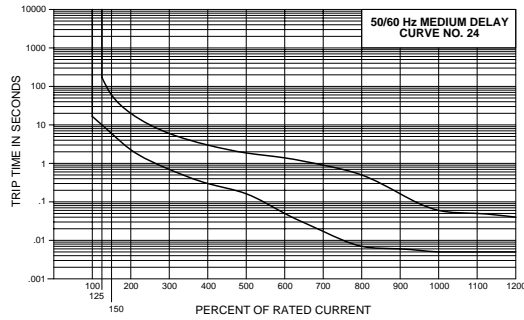

Long

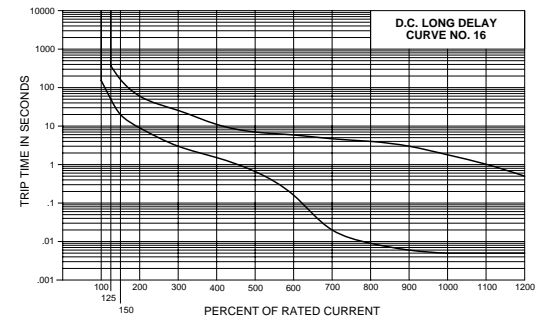
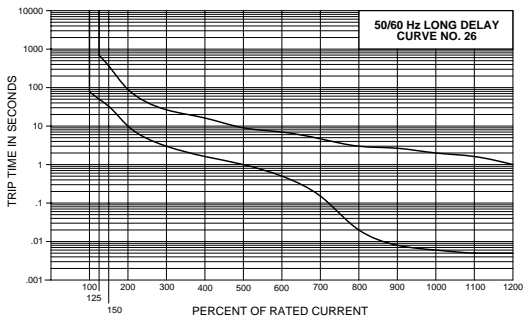

NOTES

UL489 C-Series Breakers available with Delay Curves 11, 12, 14, 16, 21, 22, 24, 26, 42, 44, 46

Delay Curves 11,12,14,16,21,22,24,26,42,44,46: Breakers to hold 100% and must trip at 125% of rated current and greater within the time limit shown in this curve.

Delay Curves 32,34,36: Breakers to hold 100% and must trip at 135% of rated current and greater within the time limit shown in this curve.

Delay Curves 10,20: Breakers to hold 100% and must trip at 150% of rated current and greater within the time limit shown in this curve.

All Curves: Curve data shown represents breaker response at ambient temperature of 77°F (25°C) with no preloading. Breakers are mounted in standard wall-mount position.

On 50 amp and less current ratings, the minimum inrush pulse tolerance handling capability is 12 times the rated current on standard delays and 25 times the rated current on high inrush delays. These values are based on a 60 Hz 1/2 cycle, 8 ms pulse. High inrush delays should be specified for applications with high initial surge currents of short duration such as switching power supplies, highly capacitive and transformer loads.

Time Delay Values (A, B, C & D-Series)

HI-INRUSH AC Delay Curves

Dual Rated AC/DC Delay Curves

Short

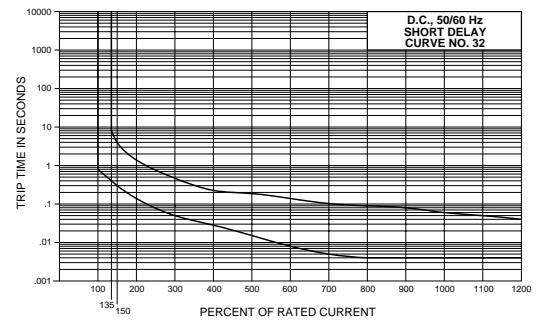
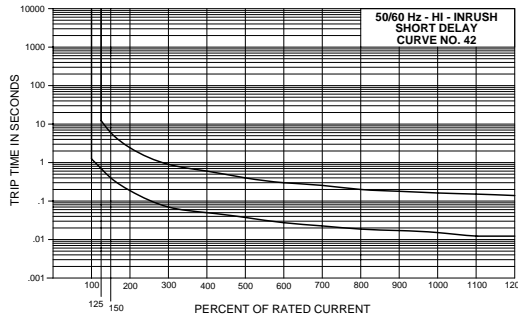

Medium

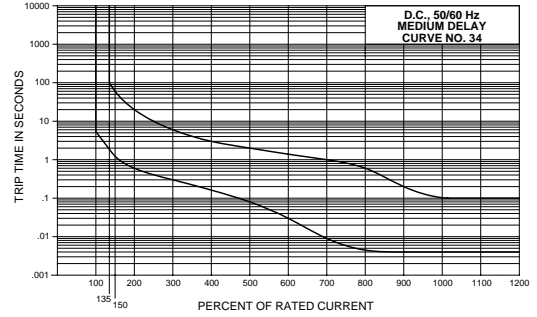
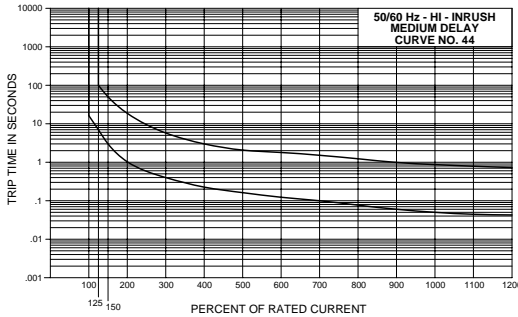

Long

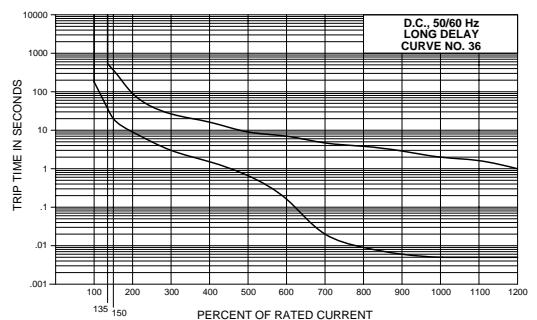
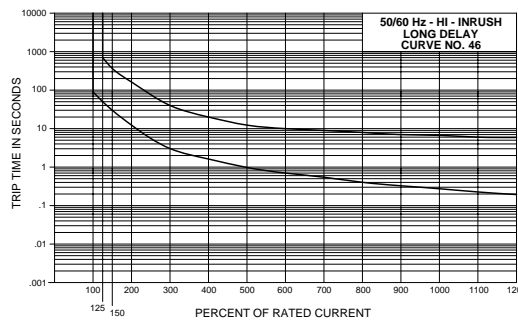

		PERCENT OF RATED CURRENT										
		DELAY	100%	125%	135%	150%	200%	400%	600%	800%	1000%	1200%
TRIP TIME (SECONDS)	10	NO TRIP	MAY TRIP	---	.032 MAX	.024 MAX	.020 MAX	.018 MAX	.016 MAX	.015 MAX	.013 MAX	
	11	NO TRIP	.013 - .125	---	.010 - .070	.008 - .032	.006 - .020	.005 - .020	.004 - .020	.004 - .020	.004 - .020	
	12	NO TRIP	.500 - 6.50	---	.300 - 3.00	.130 - 1.20	.031 - .220	.011 - .120	.004 - .090	.004 - .060	.004 - .040	
	14	NO TRIP	2.00 - 60.0	---	1.20 - 40.0	.600 - 20.0	.150 - 3.00	.030 - 1.30	.004 - .600	.004 - .100	.004 - .100	
	16	NO TRIP	45.0 - 345	---	20.0 - 150	9.00 - 60.0	1.40 - 11.4	.150 - 5.80	.009 - 3.70	.005 - 1.70	.005 - 5.00	
	20	NO TRIP	MAY TRIP	---	.040 MAX	.035 MAX	.030 MAX	.025 MAX	.020 MAX	.017 MAX	.015 MAX	
	21	NO TRIP	.014 - .150	---	.011 - .095	.008 - .055	.006 - .035	.005 - .027	.005 - .021	.004 - .018	.004 - .017	
	22	NO TRIP	.700 - 12.0	---	.350 - 4.00	.130 - 1.30	.027 - .220	.008 - .130	.004 - .090	.004 - .045	.004 - .040	
	24	NO TRIP	10.0 - 160	---	6.00 - 60.0	2.20 - 20.0	.300 - 3.00	.050 - 1.30	.007 - .500	.005 - .060	.005 - .040	
	26	NO TRIP	50.0 - 700	---	32.0 - 350	10.0 - 90.0	1.50 - 15.0	.500 - 7.00	.020 - 3.00	.006 - 2.00	.005 - 1.00	
	32	NO TRIP	MAY TRIP	.400 - 8.00	.300 - 4.00	.130 - 1.30	.027 - .220	.008 - .130	.004 - .090	.004 - .060	.004 - .040	
	34	NO TRIP	MAY TRIP	1.80 - 100	1.20 - 60.0	.600 - 20.0	.150 - 3.00	.030 - 1.30	.004 - .600	.004 - .110	.004 - .100	
	36	NO TRIP	MAY TRIP	35.0 - 520	20.0 - 350	9.00 - 90.0	1.40 - 15.0	.150 - 7.00	.009 - 3.70	.005 - 2.00	.004 - 1.00	
	42	NO TRIP	.700 - 12.0	---	.400 - 6.00	.180 - 2.30	.050 - .600	.026 - .300	.018 - .200	.014 - .150	.012 - .130	
44	NO TRIP	7.00 - 100	---	3.00 - 50.0	1.10 - 18.0	.220 - 3.00	.120 - 1.70	.075 - 1.20	.050 - .850	.042 - .720		
46	NO TRIP	50.0 - 700	---	31.0 - 350	12.0 - 150	1.50 - 20.0	.700 - 10.0	.404 - 7.90	.260 - 6.50	.198 - 5.80		
52	NO TRIP	.500 - 6.50	---	.340 - 4.50	.180 - 2.30	.051 - .600	.030 - .320	.018 - .220	.014 - .200	.012 - .130		
54	NO TRIP	1.50 - 50.0	---	.750 - 35.0	.350 - 18.0	.110 - 3.00	.070 - 1.70	.045 - 1.40	.039 - 1.30	.035 - 1.30		
56	NO TRIP	45.0 - 345	---	19.0 - 170	8.50 - 100	1.24 - 15.0	.410 - 9.00	.256 - 8.00	.210 - 5.50	.198 - 2.90		

NOTES

UL489 C-Series Breakers available with Delay Curves 11, 12, 14, 16, 21, 22, 24, 26, 42, 44, 46.

Delay Curves 11,12,14,16,21,22,24,26,42,44,46: Breakers to hold 100% and must trip at 125% of rated current and greater within the time limit shown in this curve.

Delay Curves 32,34,36: Breakers to hold 100% and must trip at 135% of rated current and greater within the time limit shown in this curve.

Delay Curves 10,20: Breakers to hold 100% and must trip at 150% of rated current and greater within the time limit shown in this curve.

All Curves: Curve data shown represents breaker response at ambient temperature of 77°F (25°C) with no preloading. Breakers are mounted in standard wall-mount position.

On 50 amp and less current ratings, the minimum inrush pulse tolerance handling capability is 12 times the rated current on standard delays and 25 times the rated current on high inrush delays. These values are based on a 60 Hz 1/2 cycle, 8 ms pulse. High inrush delays should be specified for applications with high initial surge currents of short duration such as switching power supplies, highly capacitive and transformer loads.

Time Delay Values (A, B, C & D-Series) HI-INRUSH DC Delay Curves

Short

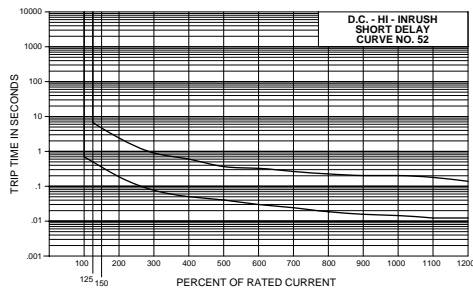

Medium

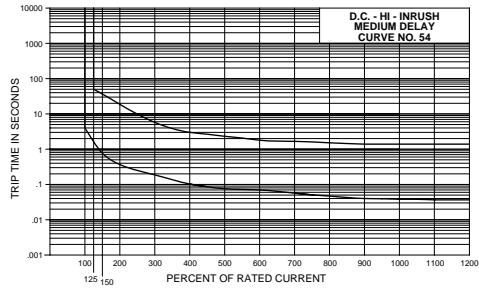

Long

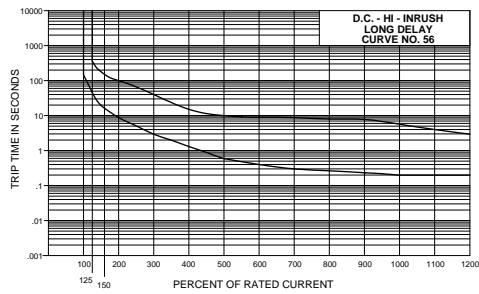

A-Series – Handle Actuator

Compact, temperature stable, magnetic design for precision operation in domestic market applications.

1-6 poles (handle), 1-3 poles (rocker), 0.02 - 50 amps, up to 277 VAC or 80 VDC, with a choice of time delays, terminals and actuator colors.

When front panel operation and aesthetics demand a clean contemporary design, the unique visi-rocker two-color actuator can be specified to indicate either the ON or the TRIPPED/OFF mode. Available in three Visi-Rocker color combinations and seven solid colors. *New* A-Series Rockerguard and push-to-reset bezel help prevent inadvertent actuation.

Agency Approvals

UL Recognized under the Component Recognition Program as Protectors, Supplementary (Guide QVNU2, File E75596), UL Standard 1077. Switches, Industrial Control (Guide NRNT2, File E148683), UL Standard 508. Protectors, Supplementary for Marine Electrical and Fuel Systems (Guide PEQZ2, File E75596), UL Standard 1500 (Ignition - Protection).

CSA Certified under Class 909101, File LR47848.

VDE Certified to DIN VDE 0660, Part 101/09.82 under VDE - Reg.- Nr. 2495. (VDE on rocker style only)

A-Series – Rocker Actuator

General Specifications

ELECTRICAL

Table A: Lists UL Recognized, CSA & VDE Certified configurations & performance capabilities as a Component Supplementary Protector. (VDE for rocker style only.)

AS A COMPONENT SUPPLEMENTARY PROTECTOR							
CIRCUIT CONFIGURATION	VOLTAGE			CURRENT RATING FULL LOAD AMPS	INTERRUPTING CAPACITY, AMPS		
	MAX RATING	FREQUENCY	PHASE		with BACKUP FUSE	without BACKUP FUSE	
					UL/CSA	UL/CSA ¹ .	VDE 1.
SERIES	65	D.C.	--	31 - 50	--	3000	--
	80	D.C.	--	0.02 - 30	--	3000	1500
	250	50/60 Hz	1 & 3 Ø	0.02 - 20	5000 (•)	--	1500
	250	50/60 Hz	1 & 3 Ø	21 - 30	2000 (•)	--	1500
	125/250	50/60 Hz	1 Ø	0.02 - 30	[5000] (**)	3000	--
	125/250	50/60 Hz	1 Ø	31 - 50	--	2000	--
	250	50/60 Hz	1 Ø, (**)	31 - 50	2000 (•)	--	--
	277	50/60 Hz	1 Ø	0.02 - 30	5000 (•)	--	--
DUAL COIL	80	D.C.	--	0.02 - 30	--	3000	3000(****)
	250	50/60 Hz	1 & 3 Ø	0.02 - 20	5000 (•)	--	1500(****)
	250	50/60 Hz	1 & 3 Ø	21 - 30	2000 (•)	--	1500(****)
	277	50/60 Hz	1 Ø	0.02 - 30	[5000] (**)	--	--
SHUNT	80	D.C.	--	0.02 - 30	3500 (•)	3000	1500
	250	50/60 Hz	1 & 3 Ø	0.02 - 20	5000 (•)	--	1500
	250	50/60 Hz	1 & 3 Ø	21 - 30	2000 (•)	--	1500
	277	50/60 Hz	1 Ø	0.02 - 30	[5000] (**)	--	--
RELAY	80	D.C.	--	0.02 - 30	3500 (•)	3000	--
	250	50/60 Hz	1 & 3 Ø	0.02 - 20	5000 (•)	--	--
	250	50/60 Hz	1 & 3 Ø	21 - 30	2000 (•)	--	--
	277	50/60 Hz	1 Ø	0.02 - 30	[5000] (**)	--	--
SWITCH ONLY	65	D.C.	--	0.02 - 50			
	80	D.C.	--	0.02 - 30			
	250	50/60 Hz	1 & 3 Ø	0.02 - 50			
	277 (**)	50/60 Hz	1 Ø	0.02 - 30			

Table B: Lists UL Recognized, CSA Certified configurations and performance capabilities as Protectors, Supplementary for Marine Electrical and Fuel Systems (Guide PEQZ2, File E75596). Ignition Protected per UL Standard 1500. UL Classified Small Craft Electrical Devices, Marine in accordance with ISO8846 (Guide UZMK, File MQ1515) as Marine Supplementary Protectors.

UL - 1500 (MARINE IGNITION PROTECTED)					
CIRCUIT CONFIGURATION	VOLTAGE			CURRENT RATING	INTERRUPTING CAPACITY AMPS
	MAX RATING	FREQ.	PHASE	FULL LOAD AMPS	
SERIES	65	D.C.	-	0.02 - 50	1500 (1)
	125/250	50/60 Hz	1Ø	0.02 - 50	1500 (1)
	250	50/60 Hz	1Ø	0.02 - 30	1000 (1)

Maximum Voltage 277VAC 50/60 Hz, 80VDC
 Current Ratings Standard current coils: 0.100, 0.250, 0.500, 0.750, 1.00, 2.50, 5.00, 7.50, 10.0, 15.0, 20.0, 25.0, 30.0, 35.0, 40.0, 50.0. Other ratings available - consult factory.
 Standard Voltage Coils DC - 6V, 12V; AC - 120V, other ratings available, consult factory.
 Auxiliary Switch Rating SPDT; 10.1 AMPS - 250VAC, 5.0 AMPS-30VDC, 0.1 Amps - 125VAC (with gold contacts).
 Insulation Resistance Minimum of 100 Megohms at 500 VDC.
 Dielectric Strength UL, CSA - 1500V 60 Hz for one minute between all electrically isolated terminals. A-Series rocker circuit breakers comply with the 8mm spacing and 3750V dielectric requirements from hazardous voltage to operator accessible surfaces per IEC Publications 950, EN 60950 and VDE 0805.

NOTES FOR TABLE A:
 1. Interrupting capacities are without backup series fusing.
 (•) Requires branch-circuit backup with a UL LISTED Type K5 or RK5 fuse at no more than four times the rating of the highest rated protector (15A minimum).
 (**) Same as above (•) except that the backup fuse is limited to 80A max.
 (***) 2 pole protector required (with one pole per power line): for 250/125VAC, 125/250VAC and 208Y 120VAC Power Systems. 1 pole protector required: for 125VAC, 1Ø Power System.
 (****) Dual coil shunt trip only, VDE Certified

NOTES FOR TABLE B:
 1. Units do not require backup (series) fusing.

General Specifications (cont.)

Resistance, Impedance

Values from Line to Load Terminal - based on Series Trip Circuit Breaker

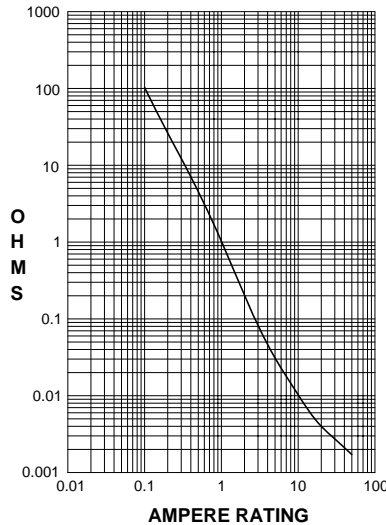

CURRENT (AMPS)	TOLERANCE (%)
0.100 - 5.0	±15
5.1 - 20.0	±25
20.1 - 50.0	±35

Pulse Tolerance Curves

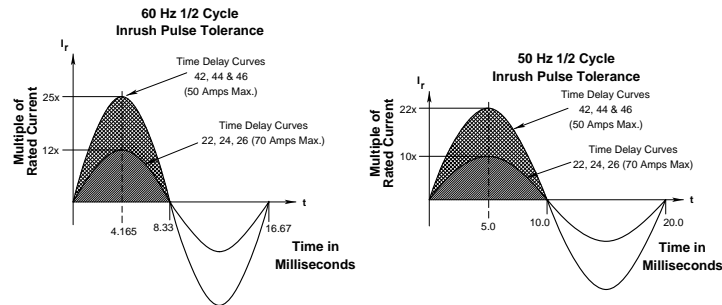

MECHANICAL

Endurance

10,000 ON-OFF operations @ 6 per minute; with rated Current and Voltage

Trip Free

All A-Series Circuit Breakers will trip on overload, even when the actuator is forcibly held in the ON position.

Trip Indication

The operating actuator moves positively to the OFF position when an overload causes the circuit breaker to trip. When mid-trip handle is specified, the handle moves to the mid position on electrical trip of the circuit breaker. When mid-trip handle with alarm switch is specified, the handle moves to the mid position and the alarm switch actuates when the circuit breaker is electrically tripped.

ENVIRONMENTAL

Environmental

Designed and tested in accordance with requirements of specification MIL-C-55629 and MIL-STD-202 as follows:

Shock

Withstands 100 Gs, 6ms, sawtooth while carrying rated current per Method 213, Test Condition "I". Instantaneous and ultra-short curves tested @ 90% of rated current.

Vibration

Withstands 0.060" excursion from 10-55 Hz, and 10 Gs 55-500 Hz, at rated current per Method 204C, Test Condition A. Instantaneous and ultrashort curves tested at 90% of rated current.

Moisture Resistance

Method 106D; ten 24-hour cycles @ +25°C to +65°C, 80-98% RH. 56 days @ +85°C, 85% RH.

Salt Spray

Method 101, Condition A (90-95% RH @ 5% NaCl Solution, 96 hrs).

Thermal Shock

Method 107D, Condition A (Five cycles @ -55°C to +25°C to +85°C to +25°C).

Operating Temperature

-40° C to +85° C

PHYSICAL

Number of Poles

1 - 6 Poles (handle) and 1-3 poles (rocker) at 30 Amps or less. 1 and 2 poles at 31 Amps thru 50 Amps.

Internal Circuit Configurations

Series, (with or without auxiliary switch), Shunt and Relay with current or voltage trip coils, Dual Coil, Switch Only with or without auxiliary switch.

Weight

Approximately 65 grams/pole (Approximately 2.32 ounces/pole)

Standard Colors

Housing - Black; Actuator- See Ordering Scheme.

Circuit and Terminal Diagrams

CIRCUIT BREAKER PROFILE	CIRCUIT SCHEMATIC		CIRCUIT SCHEMATIC			
	ANSI	CIRCUIT CODE AUX SWITCH CODE	ANSI	CIRCUIT CODE AUX SWITCH CODE		
2 TERMINALS 	SWITCH ONLY (NO COIL) 	A	0	SERIES TRIP 	B C	0
5 TERMINALS 	SWITCH ONLY (NO COIL) WITH AUXILIARY SWITCH 	A	1 2 3 4	SERIES TRIP WITH (3) AUXILIARY/ALARM SWITCH 	B C	1 2 3 4
3 TERMINALS 	SHUNT TRIP 	D E	0	DUAL COIL: SERIES TRIP CURRENT COIL, SHUNT TRIP VOLTAGE COIL 	H	0
4 TERMINALS 	RELAY TRIP 	F G	0	DUAL COIL: SERIES TRIP CURRENT COIL, RELAY TRIP VOLTAGE COIL 	K	0

NOTES

- 1 All dimensions are in inches [millimeters].
- 2 Tolerance $\pm .015$ [.38] unless otherwise specified.
- 3 Alarm Switch available with .110 x .020 Q.C. & Solder Lug Terminals Only.

Circuit and Terminal Diagrams

HANDLE POSITION VS. AUX/ALARM SWITCH MODE				
STANDARD C/B			MID TRIP C/B	
CIRCUIT BREAKER MODE	HANDLE POSITION	AUX. SWITCH MODE	HANDLE POSITION	ALARM SWITCH MODE
OFF				
ON				
ELECTRICAL TRIP				

AUXILIARY/ALARM SWITCH TERMINAL DETAIL

TAB (Q.C.) **TAB (Q.C.)** **SOLDER TYPE**

TERMINAL DIMENSIONAL DETAIL & RATING

TAB (Q.C.) **UPTURN LUG** **BUS**

<=30 AMP #8-32 <= 30 AMP
#10-32 <= 30 AMP #10-32 <= 50 AMP
M5 <= 30 AMP

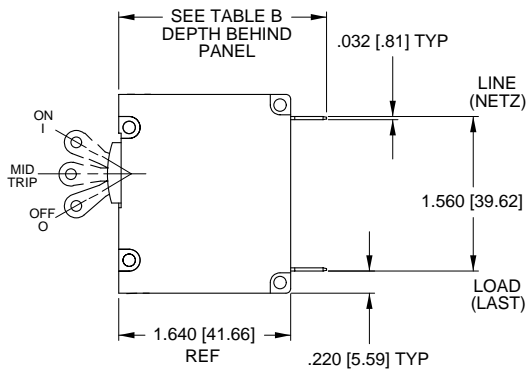

TABLE B		
TERMINAL DESCRIPTION		DEPTH BEHIND PANEL
MAIN	TAB (Q.C.)	2.000 [50.80]
	SCREW TYPE	2.032 [51.60]
SHUNT, RELAY & DUAL COIL	TAB (Q.C.)	2.207 [56.10]
	SCREW #8-32 W/UPTURNED LUGS	2.364 [60.05]
* AUX. SWITCH	.093 TAB (Q.C.)	2.095 [53.20]
	.110 TAB (Q.C.)	2.189 [55.60]
	SOLDER TYPE	1.970 [50.00]

* AVAILABLE ON SERIES TRIP AND SWITCH ONLY CIRCUITS. WHEN CALLED FOR ON MULTI-POLE UNITS, ONLY ONE AUX. SWITCH IS NORMALLY SUPPLIED, AS SHOWN IN MULTI-POLE IDENTIFICATION SCHEME. SEE PAGE

NOTES

- All dimensions are in inches [millimeters].
- Tolerance ±.015 [.38] unless otherwise specified.

Form and Fit Drawings

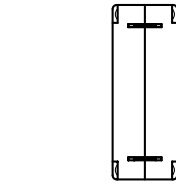
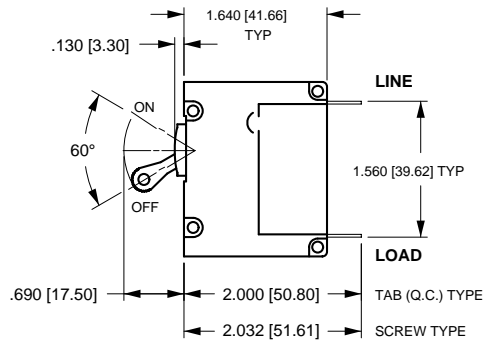
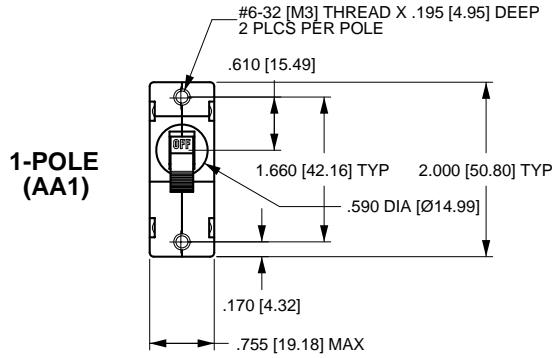

TAB (Q.C.) TYPE TERMINALS IN SERIES TRIP CIRCUIT CONFIGURATION SHOWN. FOR OTHER CONFIGURATIONS, SEE CIRCUIT AND TERMINAL DIAGRAMS.

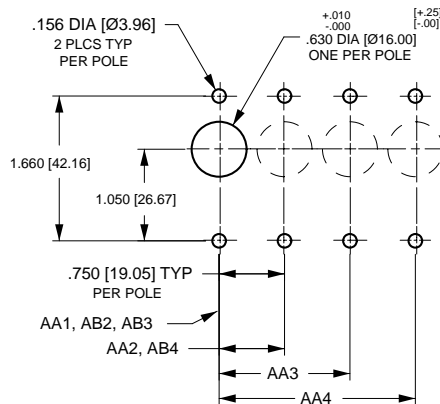
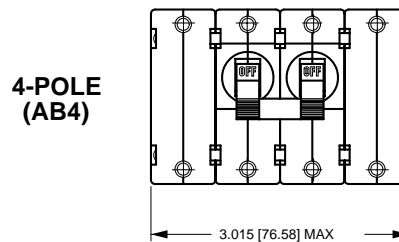
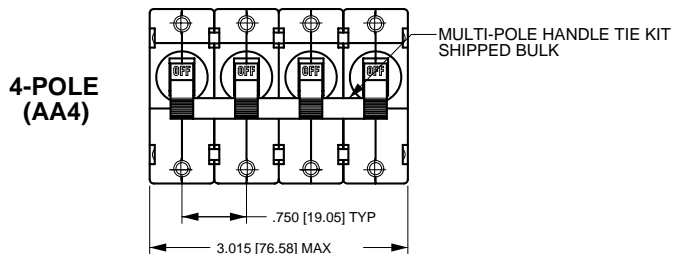
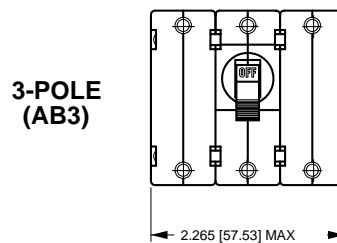
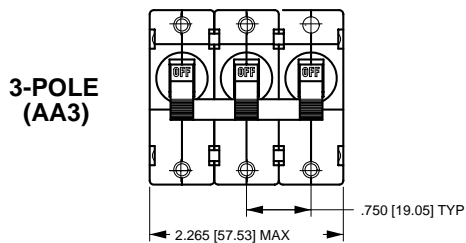
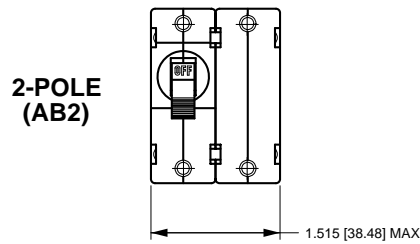
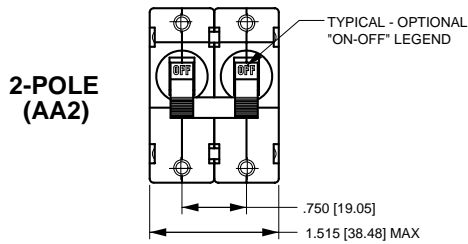

PANEL CUTOUT DETAIL

TOLERANCES ±.005 [±.12] UNLESS OTHERWISE SPECIFIED

NOTES

- All dimensions are in inches [millimeters].
- Tolerance ±.010 [.25] unless otherwise specified.

Form and Fit Drawings - Front Panel Snap-in Mounting Style 5

1 POLE
(AA1)

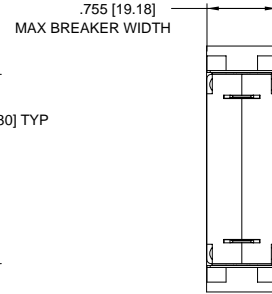
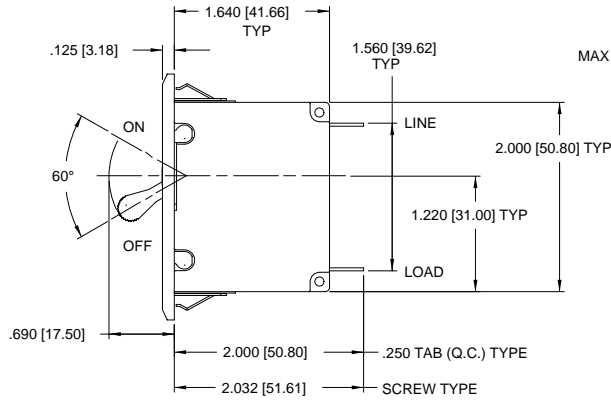
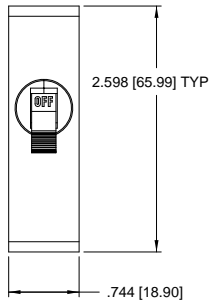

TAB (Q.C.) TYPE TERMINALS
IN SERIES TRIP CIRCUIT
CONFIGURATION SHOWN.
FOR OTHER CONFIGURATIONS,
SEE CIRCUIT AND TERMINAL
DIAGRAMS.

2 POLE
(AA2)

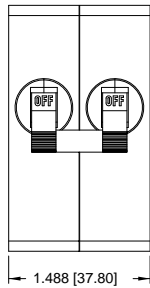

2 POLE
(AB2)

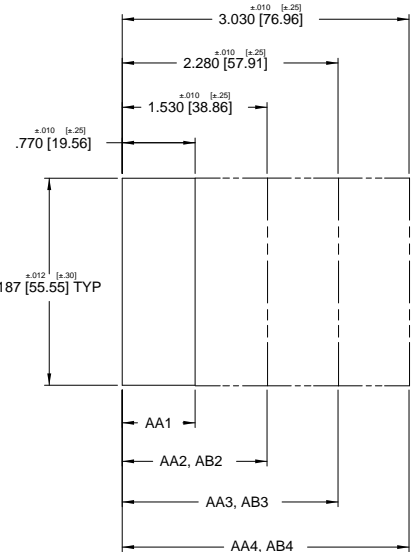
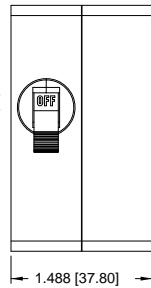

PANEL CUTOUT DETAIL

3 POLE
(AA3)

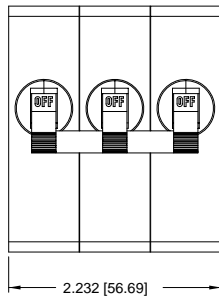

3 POLE
(AB3)

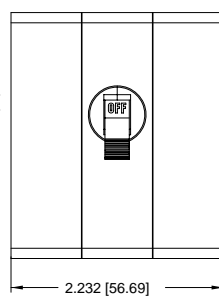

4 POLE
(AA4)

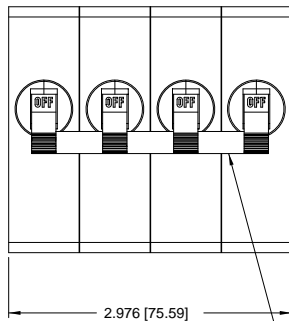

4 POLE
(AB4)

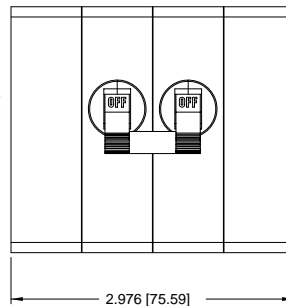

MULTI-POLE HANDLE
TIE KIT SHIPPED BULK

NOTES

- 1 All dimensions are in inches [millimeters].
- 2 Tolerance ± 0.010 [.25] unless otherwise specified.

Form and Fit Drawings - Front Panel Snap-in Mounting Style 7

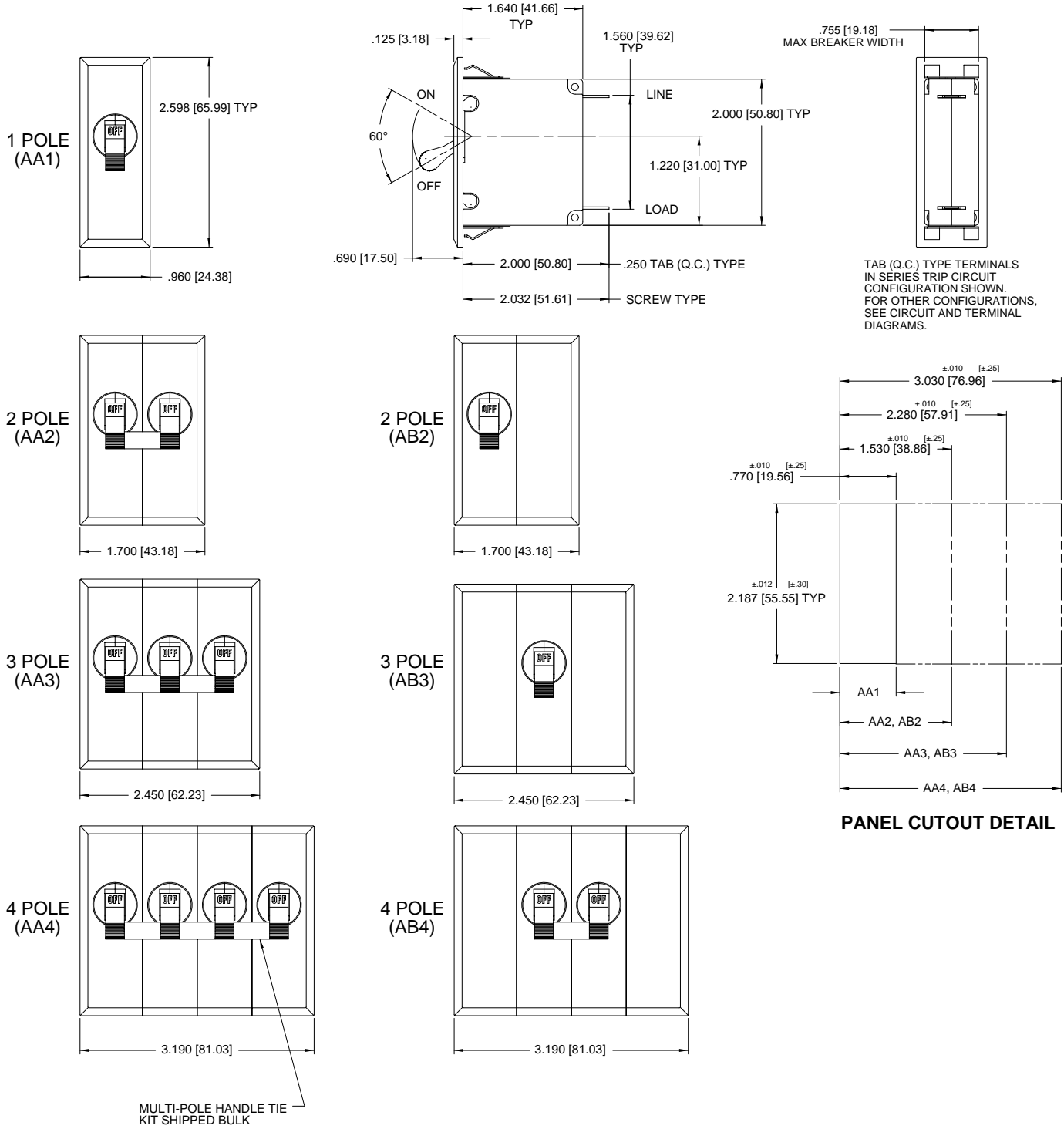

- NOTES
- 1 All dimensions are in inches [millimeters].
 - 2 Recommended panel thickness: .040 [1.02] to .100 [2.54].
 - 3 Tolerance ±.015 [±.38] unless otherwise specified.
 - 3 Schematic shown represents current trip circuit.

Circuit and Terminal Diagrams

CIRCUIT BREAKER PROFILE	CIRCUIT SCHEMATIC		CIRCUIT CODE	AUX SWITCH CODE	CIRCUIT SCHEMATIC		CIRCUIT CODE	AUX SWITCH CODE
	ANSI	IEC			ANSI	IEC		
2 TERMINALS 	SWITCH ONLY (NO COIL) LINE LOAD LINE (NETZ) LOAD (LAST)		A	0	SERIES TRIP LINE LOAD LINE (NETZ) (3) LOAD (LAST)		B	0
5 TERMINALS 	SWITCH ONLY (NO COIL) WITH AUXILIARY SWITCH LINE LOAD LINE (NETZ) LOAD (LAST)		A	1 2 3 4	SERIES TRIP WITH AUXILIARY SWITCH LINE LOAD LINE (NETZ) (3) LOAD (LAST)		B C	1 2 3 4
3 TERMINALS 	SHUNT TRIP LINE LOAD LINE (NETZ) (3) SHUNT (NEBENSCHLUSS) LOAD (LAST)		D E	0	DUAL COIL: SERIES TRIP CURRENT COIL, SHUNT TRIP VOLTAGE COIL LINE LOAD LINE (NETZ) LOAD (LAST) VOLTAGE COIL		H	0
4 TERMINALS 	RELAY TRIP LINE LOAD RELAY RELAY RELAY (RELAIS) RELAY (RELAIS) LINE (NETZ) (3) LOAD (LAST)		F G	0	DUAL COIL: SERIES TRIP CURRENT COIL, RELAY TRIP VOLTAGE COIL LINE LOAD VOLTAGE COIL LINE (NETZ) LOAD (LAST) VOLTAGE COIL		K	0

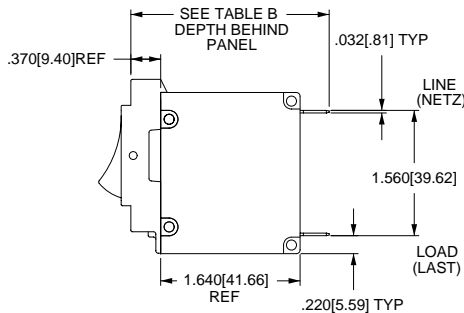

TERMINAL DESCRIPTION		DEPTH BEHIND PANEL
MAIN	TAB (Q.C.)	2.370 [60.20]
	SCREW TYPE	2.402 [61.01]
SHUNT, RELAY & DUAL COIL	TAB (Q.C.)	2.577 [65.46]
	SCREW #8-32 W/UPTURNED LUGS	2.734 [69.44]
* AUX. SWITCH	.093 TAB (Q.C.)	2.465 [62.61]
	.110 TAB (Q.C.)	2.559 [65.00]
	SOLDER TYPE	2.340 [59.44]

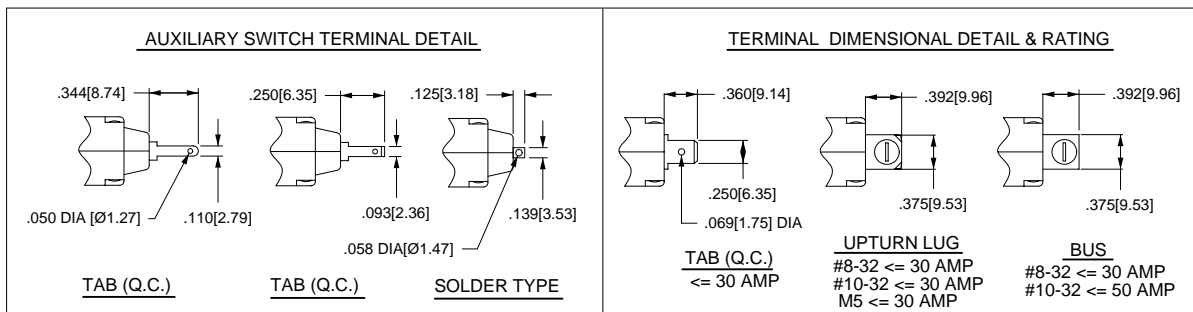

* AVAILABLE ON SERIES TRIP AND SWITCH ONLY CIRCUITS. WHEN CALLED FOR ON MULTI-POLE UNITS, ONLY ONE AUX. SWITCH IS NORMALLY SUPPLIED, AS VIEWED IN MULTI-POLE IDENTIFICATION SCHEME. SEE PAGE

NOTES

- All dimensions are in inches [millimeters].
- Tolerance ±.015 [.38] unless otherwise specified.
- Schematic shown represents current trip circuit.

Form and Fit Drawings

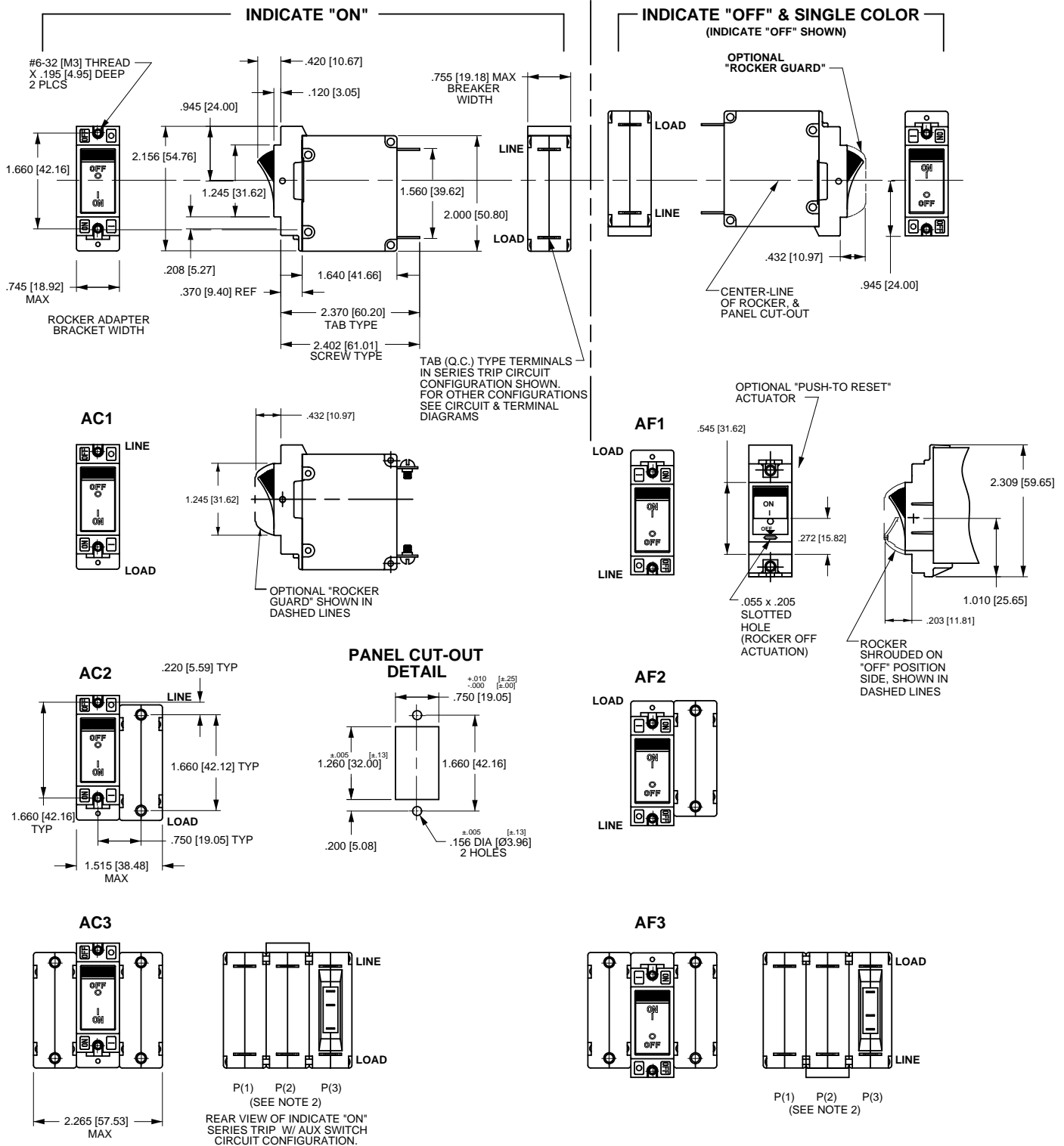

NOTES

- 1 Dimensions apply to all variations shown. Notice that circuit breaker line & load terminal orientation on indicate "OFF" is opposite of indicate "ON".
- 2 For pole orientation with horizontal legend rotate front view clockwise 90°.
- 3 All dimensions are in inches [millimeters].
- 4 Tolerance ±.010 [±.25] unless otherwise specified.

PC Terminal Diagrams

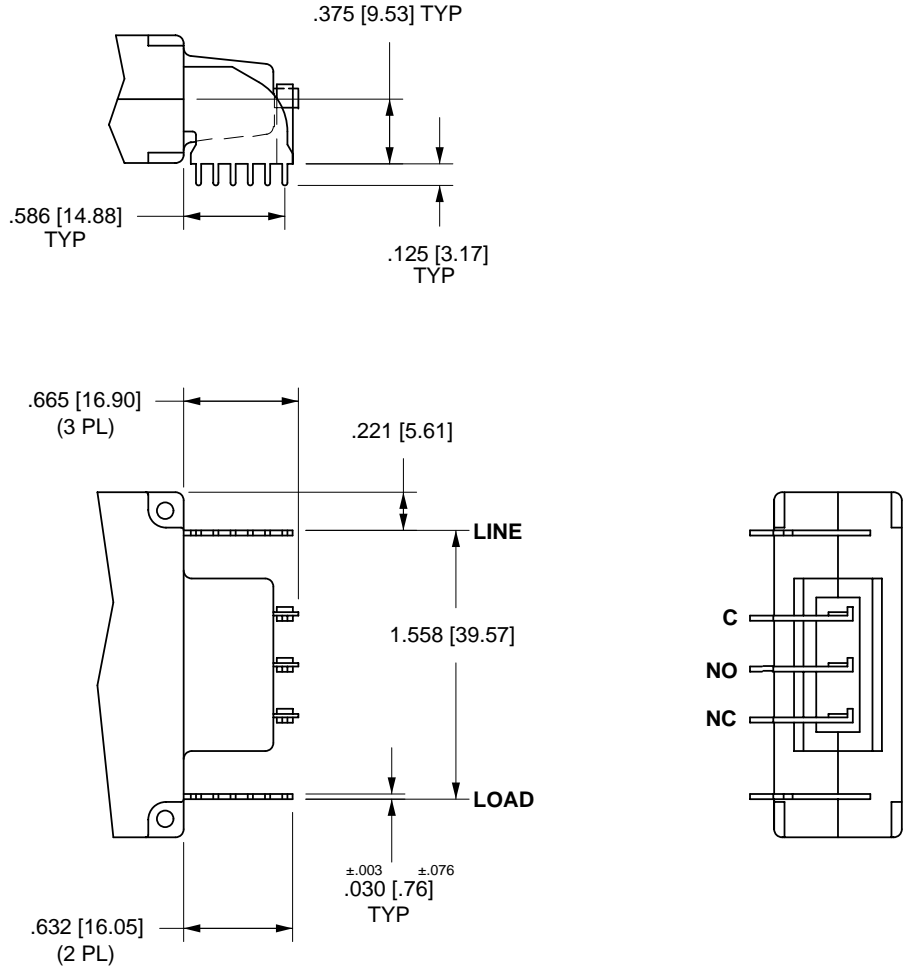

P.C. TERMINALS

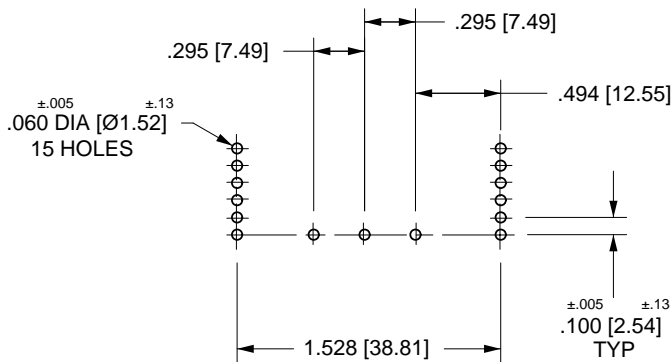

P.C. FOOT PRINT

NOTES

- 1 Drawing illustrates A-Series Rocker with VDE Certification. PC Terminals also available on A-Series Handle; consult factory.
- 2 All dimensions are in inches [millimeters].
- 3 Tolerance $\pm .010 [.25]$ unless otherwise specified.

Ordering Scheme

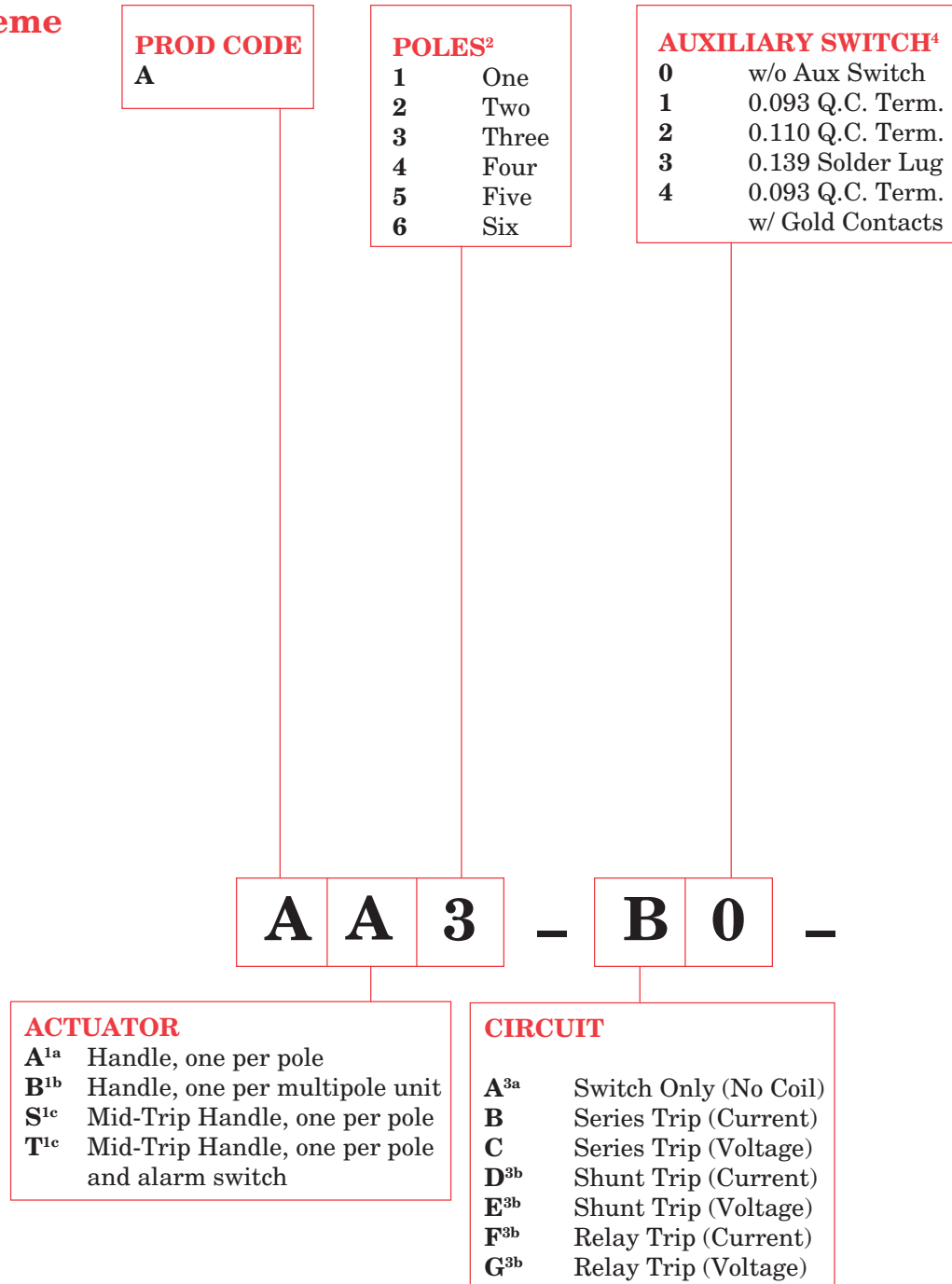

NOTES

- 1a. Actuator Option A: (One-Six Poles) Handle tie pin, spacer(s) and retainers provided unassembled with multipole units.
- 1b. Actuator Option B: Handle location as viewed from front of panel: 2 pole - left pole; 3 pole - center pole; 4 pole - two handles at center poles; 5 pole - three handles at center poles; 6 pole - four handles at center poles.
- 1c. Handle moves to mid-position only upon electrical trip of circuit breaker. Actuator code S available with circuit codes B, C, D, E, F, G, H & K. When actuator code T is specified, handle moves to mid-position and alarm switch activates only upon electrical trip of circuit breaker. Available with circuit codes B & C only.
2. Standard multipole units have all poles identical except when specifying auxiliary switch - (see Note 4 and Fig. A) and/or mixed poles (consult factory).
- 3a. "Switch Only" available to 50 amps and six poles. For 30 amps and less, select Current Rating Code 630. For 31-50 amps, select Current Rating Code 650.
- 3b. Available with Terminal Codes 1 and 2 only. Current type limited to 30 amps maximum.
4. Auxiliary switch available on Series Trip and Switch Only circuits to 30 amps. On multipole units, only one auxiliary switch is normally supplied, mounted in extreme right pole per Fig. A.
- 5a. Voltage coils not rated for continuous duty. Available only with Delay Codes 10 and 20.
- 5b. Available to 50 amps max. and with Circuit Codes B & D only.
6. For non-standard voltage or current ratings consult factory.
7. Series Trip current ratings of 35, 40 and 50 amps limited to a maximum of two poles.
8. Screw terminals are recommended on current ratings greater than 20 amps. Ratings 35, 40 and 50 amps available with Terminal Code 5 only.
9. Standard actuator colors are black and white.
10. Terminal barriers available, consult factory.

COIL RATING⁶

CURRENT COIL

	AMPERES
210	0.100
225	0.250
250	0.500
275	0.750
410	1.000
425	2.500
450	5.000
475	7.500
610	10.000
615	15.000
620	20.000
625	25.000
630	30.000
635⁷	35.000
640⁷	40.000
650⁷	50.000

VOLTAGE COIL^{5a}

	RATED MIN. TRIP	
	VOLTS	VOLTS
A06	6 DC	5 DC
A12	12 DC	10 DC
K20	120 AC	65 AC

ACTUATOR COLOR⁹

COLOR	LEGEND
B White	ON-OFF (Black)
D Black	ON-OFF (White)
G Red	ON-OFF (White)
N Yellow	ON-OFF (Black)

AGENCY APPROVAL

A	W/O Approval
B	UL Recognized
C	UL Recognized; CSA Certified
I	UL Recognized Standard 1077; UL Recognized Standard 1500 Ignition protected; CSA Certified

10 - 450 - 1 B 1 - C

FREQUENCY AND DELAY

03	DC, 50/60Hz When Delay is not applicable, i.e. Switch Only circuit option.
10^{5a}	DC Instantaneous
11	DC Ultra Short
12	DC Short
14	DC Medium
16	DC Long
20^{5a}	50/60Hz Instantaneous
21	50/60Hz Ultra Short
22	50/60Hz Short
24	50/60Hz Medium
26	50/60Hz Long
32	DC, 50/60Hz Short
34	DC, 50/60Hz Medium
36	DC, 50/60Hz Long
42^{5b}	50/60Hz Short (Hi-Inrush)
44^{5b}	50/60Hz Medium (Hi-Inrush)
46^{5b}	50/60Hz Long (Hi-Inrush)
52^{5b}	DC Short (Hi-Inrush)
54^{5b}	DC Medium (Hi-Inrush)
56^{5b}	DC Long (Hi-Inrush)

TERMINAL^{8, 10}

- 1 Push-On; 0.250 Tab (Q.C.)
- 2 Screw 8-32 w/Upturned Lugs
- 3 Screw 8-32 (Bus Type)
- 4 Screw 10-32 w/Upturned Lugs
- 5 Screw 10-32 (Bus Type)

PRINTED CIRCUIT BOARD
TERMINAL AVAILABLE;
CONSULT FACTORY

MOUNTING

1	Threaded insert 6-32 x 0.195 inches deep 2/pole
2¹⁰	Threaded insert ISO M3 x 5mm deep 2/pole
5	Front panel Snap-in, 0.75 inch wide bezel/pole
7¹⁰	Front panel Snap-in, 0.96 inch wide bezel on single pole units. .105 inch bezel overhang/side on multi-pole units

Ordering Scheme

PROD CODE
A

POLES²
1 One
2 Two
3 Three

AUXILIARY SWITCH⁴
0 w/o Aux Switch
1 0.093 Q.C. Term.
2 0.110 Q.C. Term.
3 0.139 Solder Lug
4 0.093 Q.C. Term.
w/ Gold Contacts

Figure B

ROCKER STYLE DESCRIPTIONS			
	INDICATE "ON"	INDICATE "OFF"	SINGLE COLOR
VERTICAL STYLE	<p>CODE "C"</p>	<p>CODE "F"</p>	<p>CODE "J"</p>
HORIZONTAL STYLE	<p>CODE "D"</p>	<p>CODE "G"</p>	<p>CODE "K"</p>

SHADED AREAS IDENTIFY INDICATE COLOR LOCATION

A F 1 - B 0 -

ACTUATOR¹

VISI-ROCKER¹⁰

C Indicate ON, Vertical Legends
D Indicate ON, Horizontal Legends
F Indicate OFF, Vertical legends
G Indicate OFF, Horizontal Legends

SINGLE COLOR ROCKER¹⁰

J Vertical Legends
K Horizontal Legends

PUSH TO RESET (VISI-ROCKER)^{9E}

N Indicate Off, Vertical Legends
O Indicate Off, Horizontal Legends

SINGLE COLOR ROCKER^{9E}

R Vertical Legends
U Horizontal Legends

CIRCUIT

A^{3a} Switch Only (No Coil)
B Series Trip (Current)
C Series Trip (Voltage)
D^{3b} Shunt Trip (Current)
E^{3b} Shunt Trip (Voltage)
F^{3b} Relay Trip (Current)
G^{3b} Relay Trip (Voltage)
Dual coil construction available - consult factory.

NOTES

- For description of actuator styles and legend positions refer to Figure B. Push to Reset actuators have Off portion of rocker shrouded.
- Multipole units have one rocker per unit. Rocker location as viewed from front of panel as follows: 2 pole - left pole; 3 pole - center pole. Standard multipole units have all poles identical except when specifying auxiliary switch (See note 4 and Fig A) and/or mixed poles.
- "Switch Only" available to 50 amps and three poles. For 30 amps and less, select Current Rating Code 630. For 31- 50 amps, select Current Rating Code 650.
- Available with Terminal Codes 1 and 2 only. Current type limited to 30 amps maximum.
- Auxiliary switch available on Series Trip and Switch Only circuits to 30 amps. On multipole units, only one auxiliary switch is normally supplied, mounted in extreme right pole per Fig. A.
- Voltage coils can be used on Series, Shunt, or Relay trip Dump circuit applications. These voltage coils are rated for intermittent pulse duty and are only available with delay codes 10 & 20.
- Available to 50A (UL/CSA), 30A (VDE) and Circuit Codes B & D only.
- For other voltage or current ratings consult factory.
- Screw terminals are recommended by Carlingswitch and are required by VDE on current ratings greater than 20 amps.
- Ratings 35, 40 & 50 amps available with Terminal Code 5 only.
- Color shown is Visi and Legend color with remainder of rocker black.
- DUAL=ON-OFF/I-O legend.
- Legend on Push-To-Reset Bezel/Shroud is white when single color rocker type is ordered. When visi-rocker types are ordered, the legend matches the visi-color.
- Rockerguard available with actuator codes: C,D,F,G,J, and K.
- Push-To-Reset available with actuator codes: N,O,R and U.
- Consult factory for VDE certified constructions.
- Terminal Barrier available; consult factory.

COIL RATING⁶

CURRENT COIL

AMPERES

210	0.100
225	0.250
250	0.500
275	0.750
410	1.000
425	2.500
450	5.000
475	7.500
610	10.000
615	15.000
620	20.000
625⁷	25.000
630⁷	30.000
635^{7,8}	35.000
640^{7,8}	40.000
650^{7,8}	50.000

VOLTAGE COIL^{5a}

	VOLTS	MIN. TRIP VOLTS
A06	6 DC	5 DC
A12	12 DC	10 DC
K20	120 AC	65 AC
L40	240 AC	130 AC

ACTUATOR COLOR¹

SELECT ONE

SINGLE COLOR ROCKER

VISI-ROCKER

ROCKER		VISI	
ROCKER	COLOR LEGEND ^{9b}	COLOR ^{9a}	LEGEND ^{9b}
C	Black I-O (White)	A	White I-O (White)
D	Black ON-OFF (White)	B	White ON-OFF (White)
2	Black Dual (White)	1	White Dual (White)
F	Red I-O (White)	F	Red I-O (Red)
G	Red ON-OFF (White)	G	Red ON-OFF (Red)
3	Red Dual (White)	3	Red Dual (Red)
H	Green I-O (White)	H	Green I-O (Green)
J	Green ON-OFF (White)	J	Green ON-OFF (Green)
4	Green Dual (White)	4	Green Dual (Green)
K	Blue I-O (White)		
L	Blue ON-OFF (White)		
5	Blue Dual (White)		
M	Yellow I-O (Black)		
N	Yellow ON-OFF (Black)		
6	Yellow Dual (Black)		
P	Gray I-O (Black)		
Q	Gray ON-OFF (Black)		
7	Gray Dual (Black)		
R	Orange I-O (Black)		
S	Orange ON-OFF (Black)		
8	Orange Dual (Black)		

AGENCY APPROVAL

A	W/O Approval
B	UL Recognized
C	UL Recognized; CSA Certified
D¹⁰	UL Recognized; CSA & VDE Certified
I	UL 1500 Ignition Protected; UL Recognized; CSA Certified

24

630

2

3

1

D

FREQUENCY AND DELAY

03	DC, 50/60Hz When Delay is not applicable, i.e. Switch Only circuit option.
10^{5a}	DC Instantaneous
11	DC Ultra Short
12	DC Short
14	DC Medium
16	DC Long
20^{5a}	50/60Hz Instantaneous
21	50/60Hz Ultra Short
22	50/60Hz Short
24	50/60Hz Medium
26	50/60Hz Long
32	DC, 50/60Hz Short
34	DC, 50/60Hz Medium
36	DC, 50/60Hz Long
42^{5b}	50/60Hz Short (Hi-Inrush)
44^{5b}	50/60Hz Medium (Hi-Inrush)
46^{5b}	50/60Hz Long (Hi-Inrush)
52^{5b}	DC Short (Hi-Inrush)
54^{5b}	DC Medium (Hi-Inrush)
56^{5b}	DC Long (Hi-Inrush)

TERMINAL^{7,11}

1	Push-On 0.250 Tab (Q.C.)
2	Screw 8-32 w/ Upturned Lugs
3	Screw 8-32 (Bus Type)
4	Screw 10-32 w/ Upturned Lugs
5⁸	Screw 10-32 (Bus Type)

PRINTED CIRCUIT BOARD TERMINAL AVAILABLE; CONSULT FACTORY

MOUNTING¹¹

STANDARD ROCKER BEZEL	
1	Threaded insert 6-32x0.195 in. deep
2	Threaded insert ISO M3x5mm deep
ROCKERGUARD BEZEL^{9D} or PUSH-TO-RESET BEZEL^{9C,9E}	
3	Threaded insert 6-32 x0.195 in. deep
4	Threaded insert ISO M3x5mm deep

Panel Hole Plug

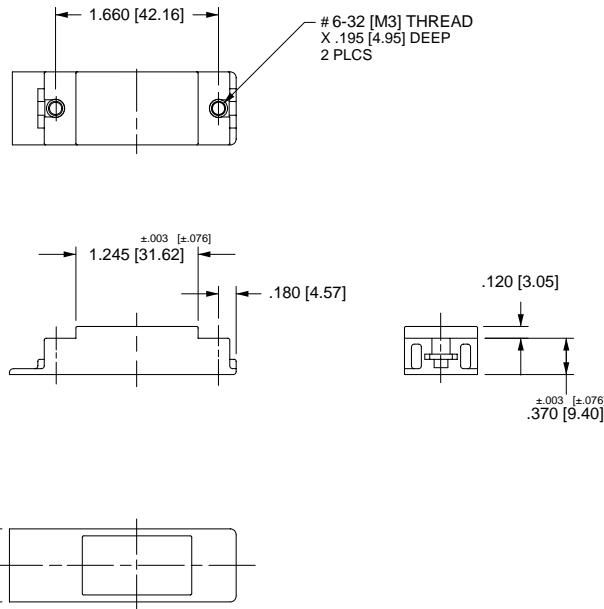
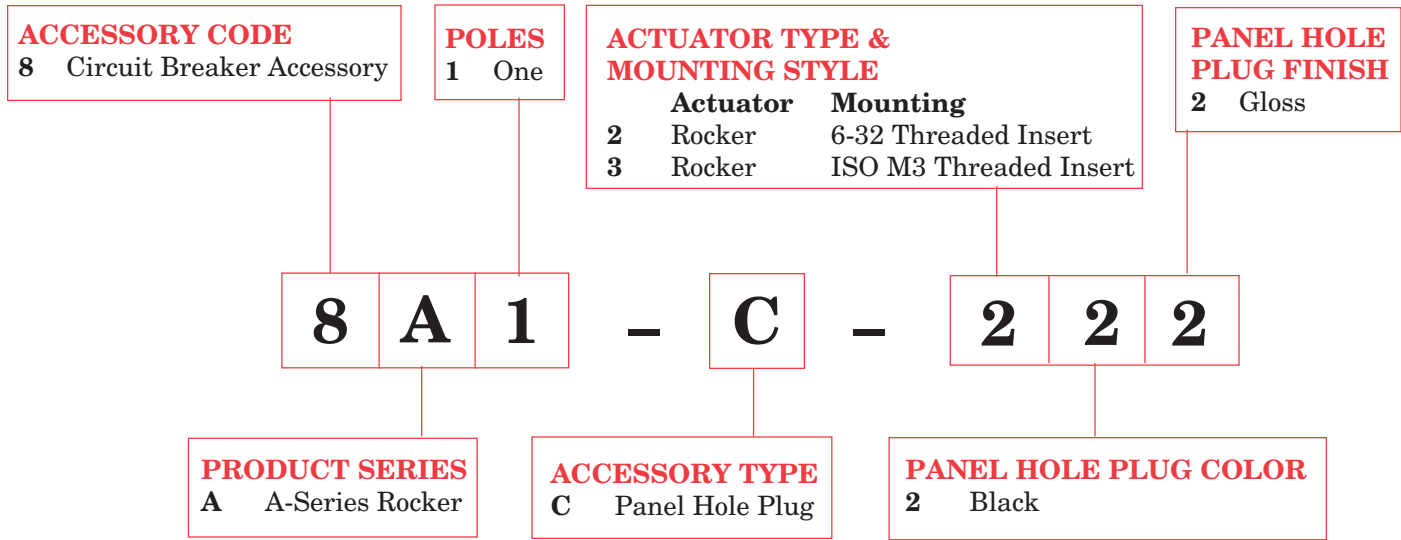

**PANEL CUT-OUT
DETAIL**

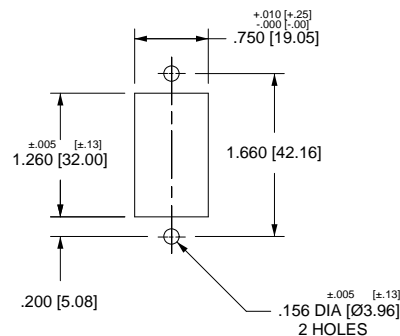

- NOTES
- All dimensions are in inches [millimeters].
 - Tolerance ±.010 [.25] unless otherwise specified.