



## FEATURES

- RoHS compliant
- Maxim MAX250/MAX251/MAX253 compatible
- BS EN 60950 approved
- Isolation to 6kV<sub>DC</sub>
- Toroidal construction
- Industry-standard pinout
- UL 94 V-0 package materials
- Fully encapsulated
- Compatible with RoHS soldering systems
- Backward compatible with Sn/Pb soldering systems

## DESCRIPTION

The 76250ENC converter transformer is specifically designed for use with Maxim chipsets to provide isolated RS232 interfaces. A carefully controlled turns ratio ensures consistent performance whilst a toroidal construction minimises EMI.

The 76253/XXENC converter transformers are specifically designed for use with the MAX253 chip set to provide isolated power supplies. The 5V version can supply 1W and the 3.3V version can supply 500mW. A centre tapped secondary winding allows for full bridge, half bridge or voltage doubling.

The devices are fully approved to BS EN 60950 for use in telecoms applications.

## SELECTION GUIDE

Order Code	Input Voltage	Output Voltage	Max. Output Current	Isolation Voltage	Turns Ratio
	V	V	mA	V <sub>DC</sub>	
<b>76250ENC</b>	-	-	-	6000	1CT:1
<b>76253/35ENC</b>	3.3	5.0	100	6000	1:√5
<b>76253/55ENC</b>	5.0	5.0	200	6000	1:1.33

## 76250ENC CHARACTERISTICS

Parameter	Conditions	Min.	Typ.	Max.	Units
Primary Inductance, L <sub>p</sub> (1&5)	10kHz, 100mV	1.0	2.0	2.5	mH
Leakage Inductance, L <sub>L</sub> (1&5) <sup>2</sup>	100kHz, 100mV		35	40	μH
Interwinding Capacitance, C <sub>ww</sub> (1&2)	100kHz, 100mV		1.5	3.0	pF
D.C. Resistance, R <sub>DC</sub> (1&5)	<0.1V <sub>DC</sub>		1.0	2.0	Ω
Volt-time Product, E <sub>T</sub> (1&5)		50			Vμs

## 76253/35ENC CHARACTERISTICS

Parameter	Conditions	Min.	Typ.	Max.	Units
Primary Inductance, L <sub>p</sub> (1&5)	100kHz, 250mV	140	200		μH
Secondary Inductance, L <sub>s</sub> (2&6)	100kHz, 250mV	700	1000		μH
Leakage Inductance, L <sub>L</sub> (1&5) <sup>2</sup>	100kHz, 250mV		5.0	7.0	μH
Interwinding Capacitance, C <sub>ww</sub> (1&2)	100kHz, 250mV		2.7	3.5	pF
D.C. Resistance, R <sub>DC</sub> (1&5)	<0.1V <sub>DC</sub>		0.4	0.8	Ω
Volt-time Product, E <sub>T</sub> (1&5)		25	35		Vμs

## 76253/55ENC CHARACTERISTICS

Parameter	Conditions	Min.	Typ.	Max.	Units
Primary Inductance, L <sub>p</sub> (1&5)	100kHz, 250mV	80		150	μH
Secondary Inductance, L <sub>s</sub> (2&6)	100kHz, 250mV	142		267	μH
Leakage Inductance, L <sub>L</sub> (1&5) <sup>2</sup>	100kHz, 250mV		7.0	10.0	μH
Interwinding Capacitance, C <sub>ww</sub> (1&2)	100kHz, 250mV		2.7	3.5	pF
D.C. Resistance, R <sub>DC</sub> (1&5)	<0.1V <sub>DC</sub>		0.5	0.9	Ω
Volt-time Product, E <sub>T</sub> (1&5)		30	40		Vμs

## ABSOLUTE MAXIMUM RATINGS

Operating free air temperature range 76250EN	0°C to 70°C
Operating free air temperature range 76253/XXEN	-40°C to 85°C
Storage temperature range	-50°C to 125°C
Lead temperature 1.5mm from case for 10 seconds	300°C
Peak current, I <sub>PK</sub> 76250EN	300mA
Peak current, I <sub>PK</sub> 76253/XXEN	400mA
Isolation voltage (flash tested for 1 second)	6000V <sub>DC</sub>

## SOLDERING INFORMATION<sup>3</sup>

Peak wave solder temperature	300°C for 10 seconds
Pin finish	Matte tin

All specifications typical at T<sub>A</sub>=25°C

- 1 Refer to mechanical dimensions for pin locations shown in brackets.
- 2 With pins 2 & 6 short circuited.
- 3 For further information, please visit [www.murata-ps.com/rohs](http://www.murata-ps.com/rohs)



**TYPICAL CHARACTERISTICS (VOLTAGE CURVES)**

**VOLTAGE CURVES**

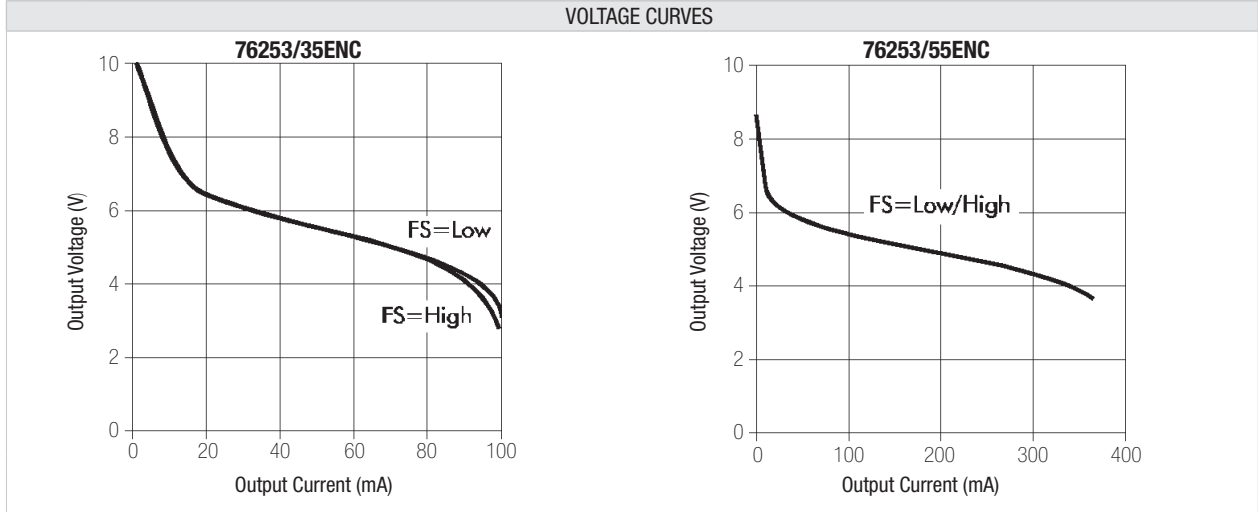

**EFFICIENCY CURVES**

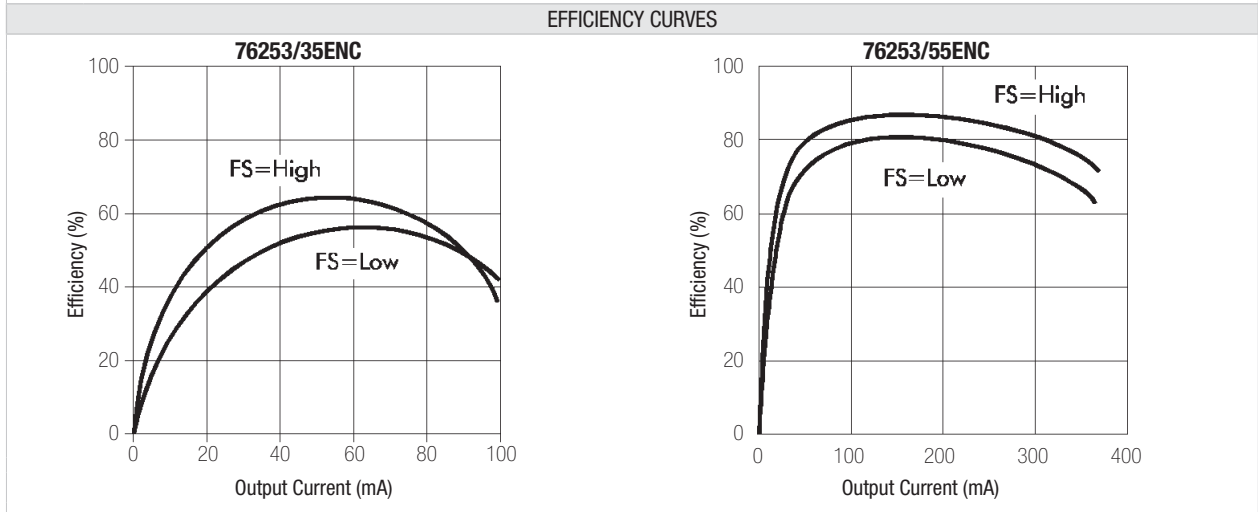

**VOLTAGE DEVIATION**

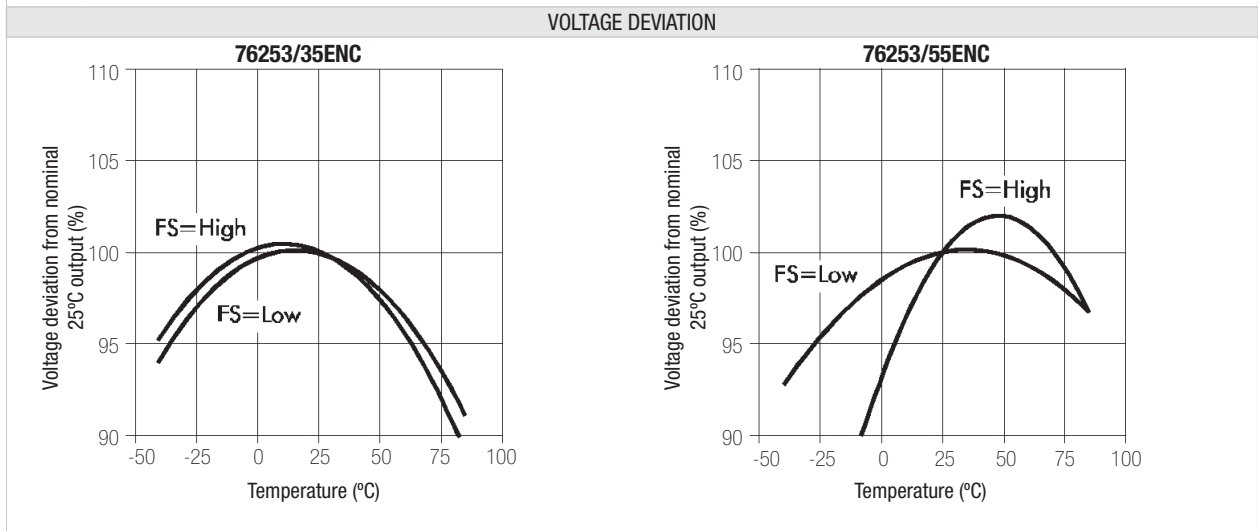

All curves are derived from testing with the Maxim MAX235 IC using the circuit shown in application note MPAN-03 (download at <http://www.murata-ps.com/data/apnotes/mpan-03.pdf>).

**PACKAGE SPECIFICATIONS**

**MECHANICAL DIMENSIONS**

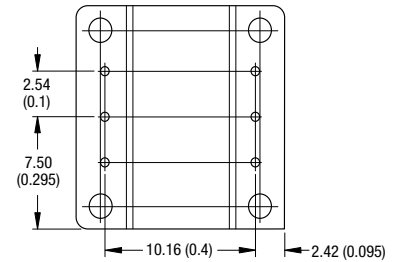
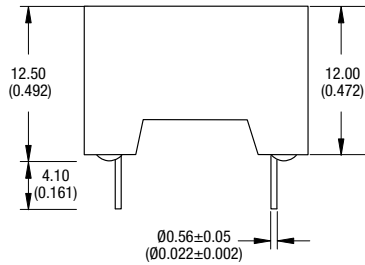
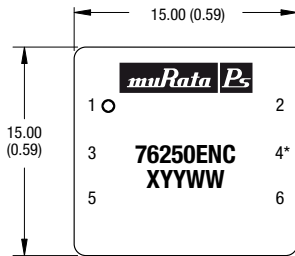

Pin Connections 76250EN (Top View)

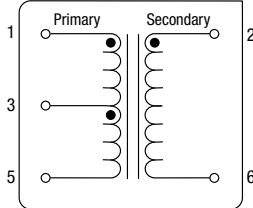

Pin Connections 76253/XXEN (Top View)

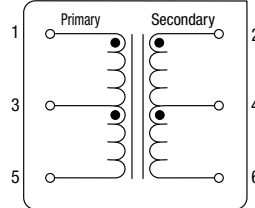

\* 76250EN Pin not fitted.  
Unless otherwise stated all dimensions in mm (inches)  $\pm 0.25\text{mm}$  ( $\pm 0.01$ ).  
All pins on a 2.54mm (0.1") pitch and within  $\pm 0.25\text{mm}$  (0.01") of true position.

**TUBE DIMENSIONS**

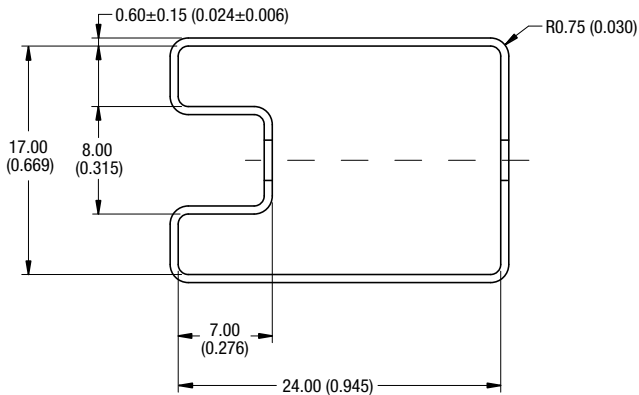

Tube length:  $480 \pm 2.00\text{mm}$  ( $18.90 \pm 0.079$ " ). Tube quantity: 30  
Tube material: Antistatic coated clear pvc.  
Unless otherwise stated all dimensions in mm (inches)  $-0.00 + 0.50$  ( $-0.00 + 0.020$ ).

**RECOMMENDED FOOTPRINT DETAILS**

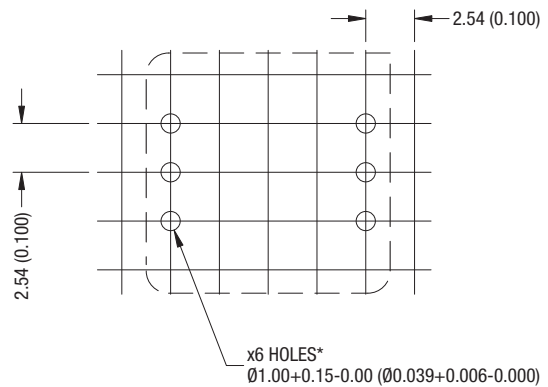

Holes may be omitted for variants with fewer than 6 pins.  
Unless otherwise stated all dimensions in mm (inches)  $\pm 0.25$  (0.01).  
All pins on a 2.54 (0.1) pitch and within  $\pm 0.25$  (0.01) of true position.

## TECHNICAL NOTES

### ISOLATION VOLTAGE

'Hi Pot Test', 'Flash Tested', 'Withstand Voltage', 'Proof Voltage', 'Dielectric Withstand Voltage' & 'Isolation Test Voltage' are all terms that relate to the same thing, a test voltage, applied for a specified time, across a component designed to provide electrical isolation, to verify the integrity of that isolation.

All products in this series are 100% production tested at their stated isolation voltage.

This series is recognised by the British Standards Institution to a working voltage of 300Vrms for Reinforced Insulation systems.

### REPEATED HIGH-VOLTAGE ISOLATION TESTING

It is well known that repeated high-voltage isolation testing of a barrier component can actually degrade isolation capability, to a lesser or greater degree depending on materials, construction and environment. We therefore strongly advise against repeated high voltage isolation testing, but if it is absolutely required, that the voltage be reduced by 20% from the specified test voltage.