

**KEMET Part Number: SSRH24NH-35086**  
(UALS24H3508600)

KEMET, SSRH24NV/NH, AC Line Filters, Common Mode, 8600 uH

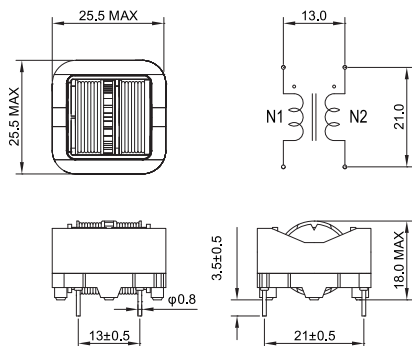

#### Dimensions

<b>L</b>	25.5mm MAX
<b>T</b>	25.5mm MAX
<b>H</b>	18mm MAX
<b>LL</b>	3.5mm +/-0.5mm
<b>S</b>	13mm NOM

#### Packaging Specifications

<b>Packaging:</b>	Tray
<b>Packaging Quantity:</b>	300
<b>Weight:</b>	22.5 g

#### General Information

<b>Series:</b>	SSRH24NV/NH
<b>Style:</b>	Through-Hole
<b>Features:</b>	Compact Size, Light Weight, Low Rdc, Ultra-High Impedance
<b>RoHS:</b>	Yes
<b>Miscellaneous:</b>	65 (K) Temperature Rise Max.

#### Specifications

<b>Voltage AC:</b>	250 VAC
<b>Inductance:</b>	8.6 mH (10 kHz)
<b>Current:</b>	3.5 A
<b>Temperature Range:</b>	-25/+120°C
<b>DC Resistance:</b>	78 mOhms