

## E2 mini | Series 10



Price index



Cleanroom Class 1 (ISO class 3)  
for Series 10, tested by the Dryden  
Engineering Company, California



Special equipment:  
Electrically conductive ESD/ATEX  
version upon request

- ❶ Large pins and double stop dog for superior life and long unsupported length
- ❷ Mounting bracket with integrated strain relief
- ❸ Dirt-repellent exterior
- ❹ Interior separation available
- ❺ One piece each link
- ❻ Easy to fill configuration
- ⬢ Series E14 Easy Chain®, page 3.32
- ❼ Snap-open configuration
- ⬢ Series 15 Zipper page, 4.18
- ⬢ Series R15 Zipper Tube, page 4.36
- ❽ Molded-in separator available  
Series 10.050.075.S



Easy to assemble and to disassemble



When to use the Series 10:

- If opening is not necessary
- If a small but very stable chain is required



When not to use it:

- If extremely quick opening of the links is necessary
  - ▶ Series 15 Zipper, page 4.18
- If quick insertion of cables with preassembled connectors is required
  - ▶ Series E14 Easy Chain®, page 3.32

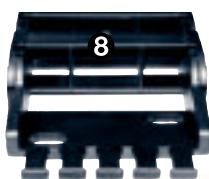

Order example complete E-Chain®

Please indicate chain-lengths or number of links Example: 1 m or 33 links

1 m 10.025.038.0



E-Chain®

with 2 separators 111 assembled every 2<sup>nd</sup> link

Interior separation

1 set 1025.12PZ



Mounting bracket



**Unsupported length**

$FL_G$  = with straight upper run

$FL_B$  = with permitted sag

Further information ► Design, page 1.12

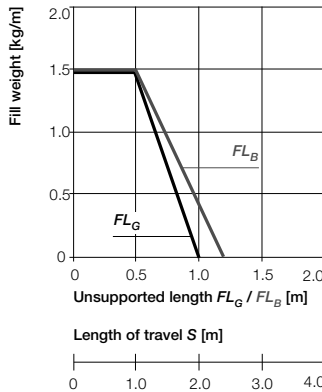
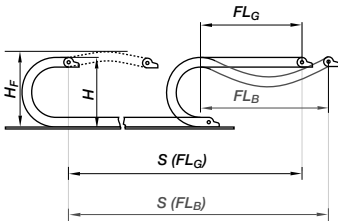

- $S$  = Length of travel
- $R$  = Bending radius
- $H$  = Nominal clearance height
- $H_F$  = Required clearance height
- $D$  = Overlength E-Chain® radius in final position
- $K = \pi \cdot R + \text{"safety"}$

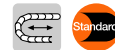
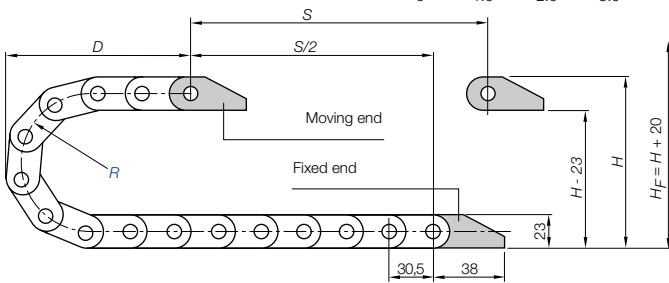

**Short travels - unsupported**

Unsupported E-Chains® feature positive camber over short travels. This must be accounted for when specifying the clearance height  $H_F$ . Please consult igus® if space is particularly restricted.

**Pitch = 30,5 mm/link Links/m = 33 (1.006,5 mm) Chain length =  $S/2 + K$**

R	028	038	048	075	100	110	125	145	180
H	80	100	120	175	225	245	275	315	385
D	70	80	90	120	145	155	170	190	225
K	150	185	215	300	375	410	455	520	630

The required clearance height:  
 $H_F = H + 20$  mm  
 (with 1,5 kg/m fill weight)

Speed / acceleration $FL_G$	max. 20 [m/s] / max. 200 [m/s <sup>2</sup> ]
Speed / acceleration $FL_B$	max. 3 [m/s] / max. 6 [m/s <sup>2</sup> ]
Gliding speed / acceleration (maximum)	max. 3 [m/s] / max. 10 [m/s <sup>2</sup> ]
Material - permitted temperature °C	igumid G / -40° up to +120° C
Flammability class, igumid G	VDE 0304 IIC UL94 HB

**Technical Data**



**Details of material properties**  
 ► page 1.38



E2 mini  
 Inner height: 18 mm

Phone +49- (0) 22 03-96 49-800  
 Fax +49- (0) 22 03-96 49-222



► page 5.47

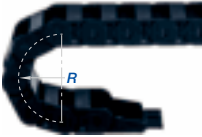
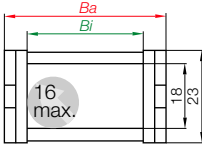

Series 10 E-Chain® - non snap-open

Part No.	Bi [mm]	Ba [mm]	R [mm]	Bending radii								Weight [kg/m]	
10.015.	.0	15	26	028	038	048	075	100	110	125	145	180	≈ 0,35
10.025.	.0	25	36	028	038	048	075	100	110	125	145	180	≈ 0,40
10.038.	.0	38	49	028	038	048	075	100	110	125	145	180	≈ 0,46
10.050.	.0	50	61	028	038	048	075	100	110	125	145	180	≈ 0,52
10.5.	.0	63	76	028	038	048	075	100	110	125	145	180	≈ 0,63
10.6.	.0	80	94	028	038	048	075	100	110	125	145	180	≈ 0,70
10.7.	.0	100	113	028	038	048	075	100	110	125	145	180	≈ 0,76

Supplement Part No. with required radius. Example: 10.025.038.0

0 = standard color, other colors ▶ page 1.39 · Pitch = 30,5 mm/link - Links/m = 33

Part No. structure

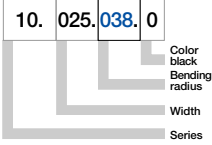

E2 mini | Series 10 | Accessories | Interior Separation

Vertical Separator

unassembled	101
assembled	111



Option 1: Vertical Separators

Vertical Separators are used if a vertical subdivision of the E-Chain® interior is required - By standard Vertical Separators are assembled every other E-Chain® link

- Standard subdivision with Vertical Separator 111

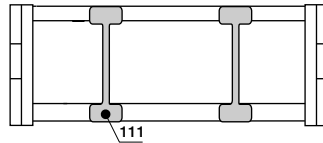

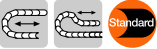

### The Standard - option polymer - pivoting

- Recommended for unsupported and gliding applications
- Well suited for tight installation conditions
- Strain relief for detachable tiwrap plates
- Variable traverse angle for flexible assembly
- The twistability of the E-Chain® and the option to assemble the mounting brackets on the fixed end and/or the moving end, enable various installation options

Moving end with bore  
(outer link) 10...3P(Z)

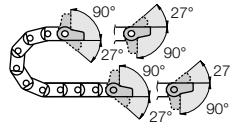

10...4P(Z) Fixed end  
with pin (inner link)

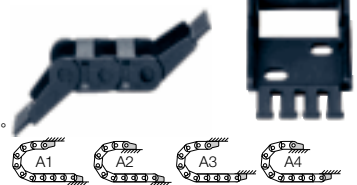

Possible installation conditions for assembled mounting brackets ▶ Order example "preassembled" below

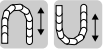

### Option polymer - locking

- Recommended for unsupported and gliding applications
- Furthermore:
- At very high speed and/or acceleration
  - If space is limited for height (the  $H_F$  measurement)
  - The twistability of the E-Chain® and the option to assemble the mounting brackets on the fixed end and/or the moving end, enable various installation options

Moving end with bore  
(outer link) 10...1P(Z)

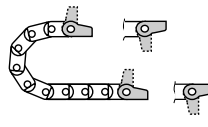

10...2P(Z) Fixed end  
with pin (inner link)



Possible installation conditions for assembled mounting brackets ▶ Order example "preassembled" below

10...3P(Z) Standard! (pivoting)  
10...1P(Z) (locking)

Standard! (pivoting) 10...4P(Z)  
(locking) 10...2P(Z)

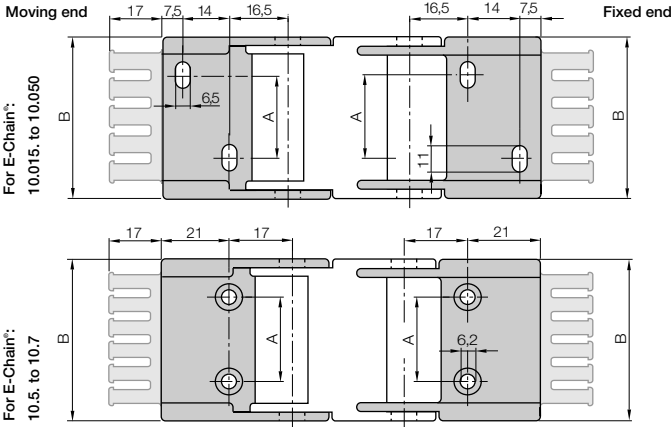

For E-Chain®	Part No. full set with tiwrap plate	Part No. full set without tiwrap plate	Dim. A [mm]	Dim. B [mm]
10.015. ▶	1015. <input type="checkbox"/> PZ	1015. <input type="checkbox"/> P	-	25,5
10.025. ▶	1025. <input type="checkbox"/> PZ	1025. <input type="checkbox"/> P	10	35,5
10.038. ▶	1038. <input type="checkbox"/> PZ	1038. <input type="checkbox"/> P	23	48,5
10.050. ▶	1050. <input type="checkbox"/> PZ	1050. <input type="checkbox"/> P	35	60,5
10.5. ▶	105. <input type="checkbox"/> PZ	105. <input type="checkbox"/> P	48	75,0
10.6. ▶	106. <input type="checkbox"/> PZ	106. <input type="checkbox"/> P	65	92,0
10.7. ▶	107. <input type="checkbox"/> PZ	107. <input type="checkbox"/> P	85	112,0

Please add the Part No. with the requested index - 34 for the pivoting configuration

e.g. 1025.  34 PZ or 12 for the locking configuration e.g. 1025.  12 PZ

For the preassembled mode please add the index  A1 ...  A4 e.g. 1025.  34  PZ  A1

### Dimensions and order configurations

Strain relief is possible on the moving end and/or the fixed end.

Part No. structure (pivoting)

1025.  34  PZ  A1

- A... must be indicated on preassembled configurations
- Full set with strain relief
- Full set pivoting = 34
- Mounting brackets for selected chain type

Full set, for both ends:

1025.  34  PZ +tiwrap plate

Single-part order:

1025.  3  PZ +tiwrap plate

Mounting bracket with bore

1025.  4  PZ +tiwrap plate

Mounting bracket with pin

Part No. structure (locking)

1025.  12  PZ  A1

- A... must be indicated on preassembled configurations
- Full set with strain relief
- Full set locking = 12
- Mounting brackets for selected chain type

Full set, for both ends:

1025.  12  PZ +tiwrap plate

Single-part order:

1025.  1  PZ +tiwrap plate

Mounting bracket with bore

1025.  2  PZ +tiwrap plate

Mounting bracket with pin

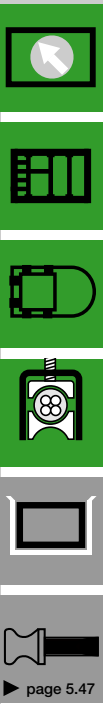

- $B_a$  = Outer width E-Chains\* / E-Tube  
 $B_i$  = Inner width E-Chains\* / E-Tube  
 $h_a$  = Outer height E-Chains\* / E-Tube  
 $H_{Ri}$  = Inner trough height  
 $H_{Ra}$  = Outer trough height  
 $B_{Ri}$  = Inner trough width ► depends on dim.  $B_a$   
 $B_{Ra}$  = Outer trough width  
 $n_{Mon}$  = Number of installation sets (left/right)  
 $n_{Ri}$  = Number of troughs sets (left/right)
- $H_{Ri} \geq 2 \cdot h_a$   
 $B_{Ri} \geq B_a + 4$
- = Guide trough set    ● = Glide bar  
● = Installation set "Basic"    ● = C-profile

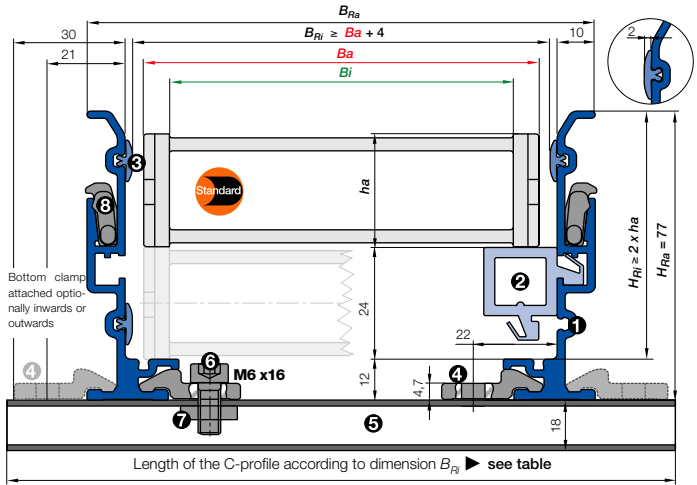

- **Components, trough "Basic":** ① Trough side parts, aluminum, 2 m ② Glide bar, plastic, 2 m ③ Glide strips, plastic, 2 m (without glide strips on request)
- **Components, installation set "Basic":** ④ Bottom clamp, aluminum ⑤ C-profile, steel galvanized ⑥ Screw M6 x 16 ⑦ Sliding nut M6 ⑧ Interface connector, plastic

### Installation set "Basic" with C-profile

Bottom Clamp attached optionally inwards or outwards

10.5.038.0 ► Order example

	$B_{Ri}$ [mm]	Part No. attached	
		inwards	outwards
.015	30	-	960.30.125
.025	40	-	960.30.150
.038	53	-	960.30.150
.050	65	960.30.125	960.30.175
.5	80	960.30.125	960.30.175
.6	98	960.30.150	960.30.200
.7	117	960.30.175	960.30.225



**Order example: Length of travel 30 m - Center mounted for Series 10.5.038.0 with  $B_{Ri} = 80$**

Guide trough set (set of 2 trough side parts, incl. glide strips) **without** glide bar

**Order text: 16 m guide trough without glide bar (8 x 2 m sections)**    **Part No. 970.30.SL**

Guide trough set (set of 2 trough side parts, incl. glide strips) **with** glide bar

**Order text: 16 m guide trough with glide bar (8 x 2 m sections)**    **Part No. 970.31.SL**

Installation set "Basic" complete (guide trough-sets + 1)

**Order text: 17 installation sets "Basic"**    **Part No. 960.30.125**

Module for the fixed end

**Order text: 1 set**    **Part No. 970.80**

**Option:** For an additional noise dampening with

silencer profile, please add Index A - Example:    **Part No. 970.30.SLA**

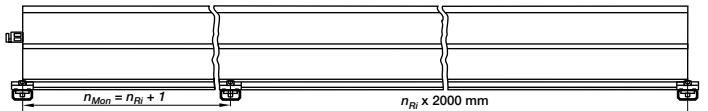

Principle sketch: Number of installation sets to be installed = **Number of trough sections + 1**

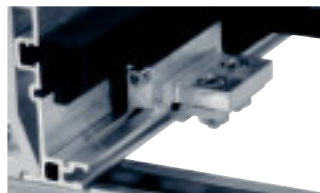

### A quick fix for mounting the stationary end of an E-Chain\*

With this module for the fixed end, fast and easy mounting onto the Aluminum "SuperTrough" is now possible without any drilling. Fast mounting of the E-Chain\* by clamping onto the aluminum trough

- Quick relocation of the stationary end
- No drilling necessary

Phone +49- (0) 22 03-96 49-800  
Fax +49- (0) 22 03-96 49-222

igus® GmbH  
51147 Cologne

Internet: www.igus.eu  
E-mail: info@igus.de