

For the electronic measurement of current: DC, AC, pulsed..., with galvanic separation between the primary and the secondary circuit.

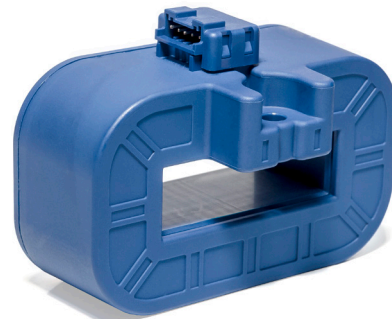

### Features

- Open loop multi-range current transducer
- Voltage output
- Single supply +5 V
- Overcurrent detect  $2.93 \times I_{PN}$  (peak value)
- Galvanic separation between primary and secondary circuit
- Low power consumption
- For busbar mounting
- Aperture: 40 × 13 mm
- Factory calibrated
- Mating JST connector:
  - housing PAP-05V-S
  - contact SPHD-00xT-P0.5.

### Advantages

- Low offset drift
- Over-drivable  $U_{ref}$
- Creepage / clearance > 10.5 mm
- Fast response
- Low profile 2 mm pitch connector for 22 to 28 AWG wire.

### Applications

- AC variable speed and servo motor drives
- Static converters for DC motor drives
- Battery supplied applications
- Uninterruptible Power Supplies (UPS)
- Switched Mode Power Supplies (SMPS)
- Power supplies for welding applications
- Combiner box
- Solar inverter on DC side of the inverter (MPPT).

### Standards

- IEC 61800-2: 2015
- IEC 61800-3: 2004
- IEC 61800-5-1: 2007
- IEC 62109-1: 2010
- UL 508: 2013.

### Application Domain

- Industrial.

## Absolute maximum ratings

Parameter	Symbol	Unit	Value
Maximum supply voltage (not destructive)	$U_{C \max}$	V	8
Maximum supply voltage (not entering non standard modes)	$U_{C \max}$	V	6.5
Maximum primary conductor temperature	$T_{B \max}$	°C	120
Electrostatic discharge voltage	$U_{ESD}$	kV	2

Stresses above these ratings may cause permanent damage. Exposure to absolute maximum ratings for extended periods may degrade reliability.

## UL 508: Ratings and assumptions of certification

File # E189713 Volume: 2 Section: 5

### Standards

- CSA C22.2 NO. 14-10 INDUSTRIAL CONTROL EQUIPMENT - Edition 12
- UL 508 STANDARD FOR INDUSTRIAL CONTROL EQUIPMENT - Edition 17

### Ratings

Parameter	Symbol	Unit	Value
Primary potential involved		V AC/DC	600
Max surrounding air temperature	$T_A$	°C	100
Primary current	$I_P$	A	According to series primary current
Secondary supply voltage	$U_C$	V DC	5
Output voltage	$U_{out}$	V	0 to 5

### Conditions of acceptability

- 1 - These devices have been evaluated for overvoltage category III and for use in pollution degree 2 environment.
- 2 - A suitable enclosure shall be provided in the end-use application.
- 3 - The terminals have not been evaluated for field wiring.
- 5 - Primary terminals shall not be straightened since assembly of housing case depends upon bending of the terminals.
- 6 - Any surface of polymeric housing have not been evaluated as insulating barrier.
- 7 - Low voltage control circuit shall be supplied by an isolating source (such as a transformer, optical isolator, limiting impedance or electro-mechanical relay).

### Marking

Only those products bearing the UR Mark should be considered to be Listed or Recognized and covered under UL's Follow-Up Service. Always look for the Mark on the product.

**Insulation coordination**

Parameter	Symbol	Unit	Value	Comment
RMS voltage for AC insulation test 50/60 Hz/1 min	$U_d$	kV	5.1	
Impulse withstand voltage 1.2/50 $\mu$ s	$U_{Ni}$	kV	9.6	
Partial discharge RMS test voltage ( $q_m < 10$ pC)	$U_t$	V	1650	Busbar/secondary. According to: IEC 61800-5-1 IEC 62109-1
Clearance (pri. - sec.)	$d_{Cl}$	mm	> 10.5	Shortest distance through air
Creepage distance (pri. - sec.)	$d_{Cp}$	mm	> 10.5	Shortest path along device body
Case material	-	-	V0	According to UL 94
Comparative tracking index	$CTI$		600	
Application example	-	V	600	Reinforced insulation according to IEC 61800-5-1 CAT III PD2
Application example	-	V	1000	Basic insulation, non uniform field according to IEC 61800-5-1 CAT III PD2
Application example	-	V	600	According to UL 508 CAT III PD2

**Environmental and mechanical characteristics**

Parameter	Symbol	Unit	Min	Typ	Max	Comment
Ambient operating temperature	$T_A$	$^{\circ}$ C	-40		105	
Ambient storage temperature	$T_S$	$^{\circ}$ C	-40		105	
Mass	$m$	g		232		

**Electrical data HOYL 200-S-0100**

 At  $T_A = 25\text{ °C}$ ,  $U_C = +5\text{ V}$ ,  $R_L = 10\text{ k}\Omega$  unless otherwise noted (see Min, Max, typ. definition paragraph in page 12).

Parameter	Symbol	Unit	Min	Typ	Max	Comment
Primary nominal RMS current	$I_{PN}$	A		200		
Primary current, measuring range	$I_{PM}$	A	-500		500	$2.5 \times I_{PN} @ U_C \geq 4.6\text{ V}$
Number of primary turns	$N_P$	-		1		Bus bar
Supply voltage <sup>1)</sup>	$U_C$	V	4.5	5	5.5	
Current consumption	$I_C$	mA		19	25	
Reference voltage (output)	$U_{ref}$	V	2.48	2.5	2.52	Internal reference
External reference voltage (input)	$U_{Eref}$	V	0.5		2.65	
Output voltage range @ $I_{PM}$	$U_{out} - U_{ref}$	V	-2		2	Over operating temperature range
Internal series resistance of reference voltage	$R_{ref}$	$\Omega$	130	200	300	Series
Output internal resistance	$R_{out}$	$\Omega$		2	5	Series
Load capacitance	$C_L$	nF	0		6	
OCD output on resistance	$R_{onOCD}$	$\Omega$	70	95	150	Open drain, active low Over operating temperature range
OCD detection hold time	$t_{holdOCD}$	ms	0.7	1	1.4	Additional time after threshold has released
EEPROM control	$U_{out}$	mV	0		50	$U_{out}$ forced to GND when EEPROM in an error state <sup>2)</sup>
Electrical offset voltage @ $I_P = 0\text{ A}$ referred to primary	$U_{OE}$	mV	-5		5	$U_{out} - U_{ref} @ U_{ref} = 2.5\text{ V}$
Electrical offset current referred to primary	$I_{OE}$	A	-1.25		1.25	
Temperature coefficient of $U_{ref}$	$TCU_{ref}$	ppm/K	-170		170	-40 °C ... 105 °C
Temperature coefficient of $U_{OE}$ referred to primary	$TCU_{OE}$	mV/K	-0.075		0.075	-40 °C ... 105 °C
Temperature coefficient of $I_{OE}$ referred to primary	$TCI_{OE}$	mA/K	-18.75		18.75	-40 °C ... 105 °C
Nominal sensitivity	$S_N$	mV/A		4		800 mV @ $I_{PN}$
Sensitivity error @ $I_{PN}$	$\varepsilon_S$	%	-0.5		0.5	Factory adjustment
Temperature coefficient of $S$	$TCS$	ppm/K	-250		250	-40 °C ... 105 °C
Linearity error 0 ... $I_{PN}$	$\varepsilon_L$	% of $I_{PN}$	-0.5		0.5	
Linearity error 0 ... $I_{PM}$	$\varepsilon_L$	% of $I_{PM}$	-0.5		0.5	
Magnetic offset current (@ $10 \times I_{PN}$ ) referred to primary	$I_{OM}$	A	-1.27		1.27	One turn
Delay time @ 10 % of $I_{PN}$	$t_{D10}$	$\mu\text{s}$		3	3.5	@ 100 A/ $\mu\text{s}$
Delay time @ 90 % of $I_{PN}$	$t_{D90}$	$\mu\text{s}$		3	3.5	@ 100 A/ $\mu\text{s}$
Frequency bandwidth (-3 dB)	$BW$	kHz		140		Small signal
Noise voltage spectral density referred to primary 100 Hz ... 100 kHz	$u_{no}$	$\mu\text{V}/\sqrt{\text{Hz}}$		7.4		
RMS noise voltage referred to primary (DC ... 10 kHz) (DC ... 100 kHz) (DC ... 1 MHz)	$U_{no}$	mVpp		4.5 7.7 12.5		
Primary current, detection threshold	$I_{PTh}$	A	$2.64 \times I_{PN}$	$2.93 \times I_{PN}$	$3.22 \times I_{PN}$	Peak value $\pm 10\%$ , overcurrent detection OCD
Sum of sensitivity and linearity @ $I_{PN}$	$\varepsilon_{SL}$	% of $I_{PN}$	-1		1	
Sum of sensitivity and linearity @ $I_{PN} @ T_A = +105\text{ °C}$	$\varepsilon_{SL}$	% of $I_{PN}$	-3.8		3.8	
Sum of sensitivity and linearity @ $I_{PN} @ T_A = +85\text{ °C}$	$\varepsilon_{SL}$	% of $I_{PN}$	-3.1		3.1	See formula note <sup>3)</sup>

 Notes: <sup>1)</sup> 3.3 V SP version available

<sup>2)</sup> EEPROM in an error state makes the transducer behave like a reverse current saturation. Use of the OCD may help to differentiate the two cases.

$$\varepsilon_{SL}(T_A) = \varepsilon_{SL} L 25 + \left( TCS + \frac{TCI_{OE}}{I_{PN}} \right) \times |T_A - 25|$$

**Electrical data HOYL 400-S-0100**

 At  $T_A = 25\text{ °C}$ ,  $U_C = +5\text{ V}$ ,  $R_L = 10\text{ k}\Omega$  unless otherwise noted (see Min, Max, typ. definition paragraph in page 12).

Parameter	Symbol	Unit	Min	Typ	Max	Comment
Primary nominal RMS current	$I_{PN}$	A		400		
Primary current, measuring range	$I_{PM}$	A	-1000		1000	$2.5 \times I_{PN} @ U_C \geq 4.6\text{ V}$
Number of primary turns	$N_P$	-		1		Bus bar
Supply voltage <sup>1)</sup>	$U_C$	V	4.5	5	5.5	
Current consumption	$I_C$	mA		19	25	
Reference voltage (output)	$U_{ref}$	V	2.48	2.5	2.52	Internal reference
External reference voltage (input)	$U_{Eref}$	V	0.5		2.65	
Output voltage range @ $I_{PM}$	$U_{out} - U_{ref}$	V	-2		2	Over operating temperature range
Internal series resistance of reference voltage	$R_{ref}$	$\Omega$	130	200	300	Series
Output internal resistance	$R_{out}$	$\Omega$		2	5	Series
Load capacitance	$C_L$	nF	0		6	
OCD output on resistance	$R_{onOCD}$	$\Omega$	70	95	150	Open drain, active low Over operating temperature range
OCD detection hold time	$t_{holdOCD}$	ms	0.7	1	1.4	Additional time after threshold has released
EEPROM control	$U_{out}$	mV	0		50	$U_{out}$ forced to GND when EEPROM in an error state <sup>2)</sup>
Electrical offset voltage @ $I_P = 0\text{ A}$ referred to primary	$U_{OE}$	mV	-5		5	$U_{out} - U_{ref} @ U_{ref} = 2.5\text{ V}$
Electrical offset current referred to primary	$I_{OE}$	A	-2.5		2.5	
Temperature coefficient of $U_{ref}$	$TCU_{ref}$	ppm/K	-170		170	-40 °C ... 105 °C
Temperature coefficient of $U_{OE}$ referred to primary	$TCU_{OE}$	mV/K	-0.075		0.075	-40 °C ... 105 °C
Temperature coefficient of $I_{OE}$ referred to primary	$TCI_{OE}$	mA/K	-37.5		37.5	-40 °C ... 105 °C
Nominal sensitivity	$S_N$	mV/A		2		800 mV @ $I_{PN}$
Sensitivity error @ $I_{PN}$	$\varepsilon_S$	%	-0.5		0.5	Factory adjustment
Temperature coefficient of $S$	$TCS$	ppm/K	-250		250	-40 °C ... 105 °C
Linearity error 0 ... $I_{PN}$	$\varepsilon_L$	% of $I_{PN}$	-0.5		0.5	
Linearity error 0 ... $I_{PM}$	$\varepsilon_L$	% of $I_{PM}$	-0.5		0.5	
Magnetic offset current (@ $10 \times I_{PN}$ ) referred to primary	$I_{OM}$	A	-1.27		1.27	One turn
Delay time @ 10 % of $I_{PN}$	$t_{D10}$	$\mu\text{s}$		3	3.5	@ 100 A/ $\mu\text{s}$
Delay time @ 90 % of $I_{PN}$	$t_{D90}$	$\mu\text{s}$		3	3.5	@ 100 A/ $\mu\text{s}$
Frequency bandwidth (-3 dB)	$BW$	kHz		140		Small signal
Noise voltage spectral density referred to primary 100 Hz ... 100 kHz	$u_{no}$	$\mu\text{V}/\sqrt{\text{Hz}}$		6.1		
RMS noise voltage referred to primary (DC ... 10 kHz) (DC ... 100 kHz) (DC ... 1 MHz)	$U_{no}$	mVpp		4.3 6.4 9.7		
Primary current, detection threshold	$I_{PTh}$	A	$2.64 \times I_{PN}$	$2.93 \times I_{PN}$	$3.22 \times I_{PN}$	Peak value $\pm 10\%$ , overcurrent detection OCD
Sum of sensitivity and linearity @ $I_{PN}$	$\varepsilon_{SL}$	% of $I_{PN}$	-1		1	
Sum of sensitivity and linearity @ $I_{PN} @ T_A = +105\text{ °C}$	$\varepsilon_{SL}$	% of $I_{PN}$	-3.8		3.8	See formula note <sup>3)</sup>
Sum of sensitivity and linearity @ $I_{PN} @ T_A = +85\text{ °C}$	$\varepsilon_{SL}$	% of $I_{PN}$	-3.1		3.1	

**Notes:** <sup>1)</sup> 3.3 V SP version available

<sup>2)</sup> EEPROM in an error state makes the transducer behave like a reverse current saturation. Use of the OCD may help to differentiate the two cases.

$$\varepsilon_{SL}(T_A) = \varepsilon_{SL} 25 + \left( TCS + \frac{TCI_{OE}}{I_{PN}} \right) \times |T_A - 25|$$

**Electrical data HOYL 600-S-0100**

 At  $T_A = 25\text{ °C}$ ,  $U_C = +5\text{ V}$ ,  $R_L = 10\text{ k}\Omega$  unless otherwise noted (see Min, Max, typ. definition paragraph in page 12).

Parameter	Symbol	Unit	Min	Typ	Max	Comment
Primary nominal RMS current	$I_{PN}$	A		600		
Primary current, measuring range	$I_{PM}$	A	-1500		1500	$2.5 \times I_{PN} @ U_C \geq 4.6\text{ V}$
Number of primary turns	$N_P$	-		1		Bus bar
Supply voltage <sup>1)</sup>	$U_C$	V	4.5	5	5.5	
Current consumption	$I_C$	mA		19	25	
Reference voltage (output)	$U_{ref}$	V	2.48	2.5	2.52	Internal reference
External reference voltage (input)	$U_{Eref}$	V	0.5		2.65	
Output voltage range @ $I_{PM}$	$U_{out} - U_{ref}$	V	-2		2	Over operating temperature range
Internal series resistance of reference voltage	$R_{ref}$	$\Omega$	130	200	300	Series
Output internal resistance	$R_{out}$	$\Omega$		2	5	Series
Load capacitance	$C_L$	nF	0		6	
OCD output on resistance	$R_{on\text{OCD}}$	$\Omega$	70	95	150	Open drain, active low Over operating temperature range
OCD detection hold time	$t_{hold\text{OCD}}$	ms	0.7	1	1.4	Additional time after threshold has released
EEPROM control	$U_{out}$	mV	0		50	$U_{out}$ forced to GND when EEPROM in an error state <sup>2)</sup>
Electrical offset voltage @ $I_P = 0\text{ A}$	$U_{OE}$	mV	-5		5	$U_{out} - U_{ref} @ U_{ref} = 2.5\text{ V}$
Electrical offset current referred to primary	$I_{OE}$	A	-3.75		3.75	
Temperature coefficient of $U_{ref}$	$TCU_{ref}$	ppm/K	-170		170	-40 °C ... 105 °C
Temperature coefficient of $U_{OE}$ referred to primary	$TCU_{OE}$	mV/K	-0.075		0.075	-40 °C ... 105 °C
Temperature coefficient of $I_{OE}$ referred to primary	$TCI_{OE}$	mA/K	-56.25		56.25	-40 °C ... 105 °C
Nominal sensitivity	$S_N$	mV/A		1.333		800 mV @ $I_{PN}$
Sensitivity error @ $I_{PN}$	$\varepsilon_S$	%	-0.5		0.5	Factory adjustment
Temperature coefficient of $S$	$TCS$	ppm/K	-250		250	-40 °C ... 105 °C
Linearity error 0 ... $I_{PN}$	$\varepsilon_L$	% of $I_{PN}$	-0.5		0.5	
Linearity error 0 ... $I_{PM}$	$\varepsilon_L$	% of $I_{PM}$	-0.5		0.5	
Magnetic offset current (@ $10 \times I_{PN}$ ) referred to primary	$I_{OM}$	A	-1.27		1.27	One turn
Delay time @ 10 % of $I_{PN}$	$t_{D10}$	$\mu\text{s}$		3	3.5	@ 100 A/ $\mu\text{s}$
Delay time @ 90 % of $I_{PN}$	$t_{D90}$	$\mu\text{s}$		3	3.5	@ 100 A/ $\mu\text{s}$
Frequency bandwidth (-3 dB)	$BW$	kHz		140		Small signal
Noise voltage spectral density referred to primary 100 Hz ... 100 kHz	$u_{no}$	$\mu\text{V}/\sqrt{\text{Hz}}$		5.7		
RMS noise voltage referred to primary (DC ... 10 kHz) (DC ... 100 kHz) (DC ... 1 MHz)	$U_{no}$	mVpp		4.3 6.0 8.8		
Primary current, detection threshold	$I_{PTh}$	A	$2.64 \times I_{PN}$	$2.93 \times I_{PN}$	$3.22 \times I_{PN}$	Peak value $\pm 10\%$ , overcurrent detection OCD
Sum of sensitivity and linearity @ $I_{PN}$	$\varepsilon_{SL}$	% of $I_{PN}$	-1		1	
Sum of sensitivity and linearity @ $I_{PN} @ T_A = +105\text{ °C}$	$\varepsilon_{SL}$	% of $I_{PN}$	-3.8		3.8	See formula note <sup>3)</sup>
Sum of sensitivity and linearity @ $I_{PN} @ T_A = +85\text{ °C}$	$\varepsilon_{SL}$	% of $I_{PN}$	-3.1		3.1	

 Notes: <sup>1)</sup> 3.3 V SP version available

<sup>2)</sup> EEPROM in an error state makes the transducer behave like a reverse current saturation. Use of the OCD may help to differentiate the two cases.

$$^3) \varepsilon_{SL}(T_A) = \varepsilon_{SL} 25 + \left( TCS + \frac{TCI_{OE}}{I_{PN}} \right) \times |T_A - 25|$$

**Electrical data HOYL 800-S-0100**

 At  $T_A = 25\text{ °C}$ ,  $U_C = +5\text{ V}$ ,  $R_L = 10\text{ k}\Omega$  unless otherwise noted (see Min, Max, typ. definition paragraph in page 12).

Parameter	Symbol	Unit	Min	Typ	Max	Comment
Primary nominal RMS current	$I_{PN}$	A		800		
Primary current, measuring range	$I_{PM}$	A	-2000		2000	$2.5 \times I_{PN} @ U_C \geq 4.6\text{ V}$
Number of primary turns	$N_P$	-		1		Bus bar
Supply voltage <sup>1)</sup>	$U_C$	V	4.5	5	5.5	
Current consumption	$I_C$	mA		19	25	
Reference voltage (output)	$U_{ref}$	V	2.48	2.5	2.52	Internal reference
External reference voltage (input)	$U_{Eref}$	V	0.5		2.65	
Output voltage range @ $I_{PM}$	$U_{out} - U_{ref}$	V	-2		2	Over operating temperature range
Internal series resistance of reference voltage	$R_{ref}$	$\Omega$	130	200	300	Series
Output internal resistance	$R_{out}$	$\Omega$		2	5	Series
Load capacitance	$C_L$	nF	0		6	
OCD output on resistance	$R_{onOCD}$	$\Omega$	70	95	150	Open drain, active low Over operating temperature range
OCD detection hold time	$t_{holdOCD}$	ms	0.7	1	1.4	Additional time after threshold has released
EEPROM control	$U_{out}$	mV	0		50	$U_{out}$ forced to GND when EEPROM in an error state <sup>2)</sup>
Electrical offset voltage @ $I_P = 0\text{ A}$	$U_{OE}$	mV	-5		5	$U_{out} - U_{ref} @ U_{ref} = 2.5\text{ V}$
Electrical offset current referred to primary	$I_{OE}$	A	-5		5	
Temperature coefficient of $U_{ref}$	$TCU_{ref}$	ppm/K	-170		170	-40 °C ... 105 °C
Temperature coefficient of $U_{OE}$ referred to primary	$TCU_{OE}$	mV/K	-0.075		0.075	-40 °C ... 105 °C
Temperature coefficient of $I_{OE}$ referred to primary	$TCI_{OE}$	mA/K	-75		75	-40 °C ... 105 °C
Nominal sensitivity	$S_N$	mV/A		1		800 mV @ $I_{PN}$
Sensitivity error @ $I_{PN}$	$\varepsilon_S$	%	-0.5		0.5	Factory adjustment
Temperature coefficient of $S$	$TCS$	ppm/K	-250		250	-40 °C ... 105 °C
Linearity error 0 ... $I_{PN}$	$\varepsilon_L$	% of $I_{PN}$	-0.5		0.5	
Linearity error 0 ... $I_{PM}$	$\varepsilon_L$	% of $I_{PM}$	-0.5		0.5	
Magnetic offset current (@ $10 \times I_{PN}$ ) referred to primary	$I_{OM}$	A	-1.27		1.27	One turn
Delay time @ 10 % of $I_{PN}$	$t_{D10}$	$\mu\text{s}$		3	3.5	@ 100 A/ $\mu\text{s}$
Delay time @ 90 % of $I_{PN}$	$t_{D90}$	$\mu\text{s}$		3	3.5	@ 100 A/ $\mu\text{s}$
Frequency bandwidth (-3 dB)	$BW$	kHz		140		Small signal
Noise voltage spectral density referred to primary 100 Hz ... 100 kHz	$u_{no}$	$\mu\text{V}/\sqrt{\text{Hz}}$		5.5		
RMS noise voltage referred to primary (DC ... 10 kHz) (DC ... 100 kHz) (DC ... 1 MHz)	$U_{no}$	mVpp		4.2 5.8 8.4		
Primary current, detection threshold	$I_{PTh}$	A	$2.64 \times I_{PN}$	$2.93 \times I_{PN}$	$3.22 \times I_{PN}$	Peak value $\pm 10\%$ , overcurrent detection OCD
Sum of sensitivity and linearity @ $I_{PN}$	$\varepsilon_{SL}$	% of $I_{PN}$	-1		1	
Sum of sensitivity and linearity @ $I_{PN}$ @ $T_A = +105\text{ °C}$	$\varepsilon_{SL}$	% of $I_{PN}$	-3.8		3.8	
Sum of sensitivity and linearity @ $I_{PN}$ @ $T_A = +85\text{ °C}$	$\varepsilon_{SL}$	% of $I_{PN}$	-3.1		3.1	See formula note <sup>3)</sup>

 Notes: <sup>1)</sup> 3.3 V SP version available

<sup>2)</sup> EEPROM in an error state makes the transducer behave like a reverse current saturation. Use of the OCD may help to differentiate the two cases.

$$\varepsilon_{SL}(T_A) = \varepsilon_{SL} 25 + \left( TCS + \frac{TCI_{OE}}{I_{PN}} \right) \times |T_A - 25|$$

Measuring range versus external reference voltage

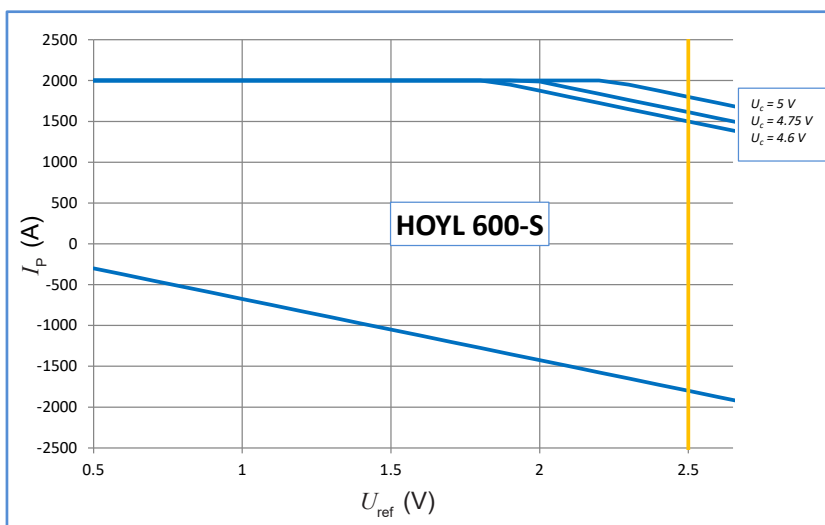
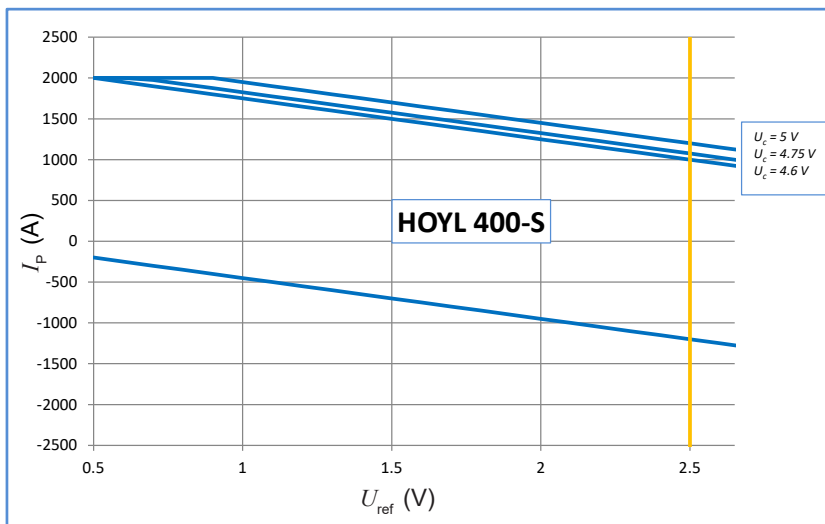
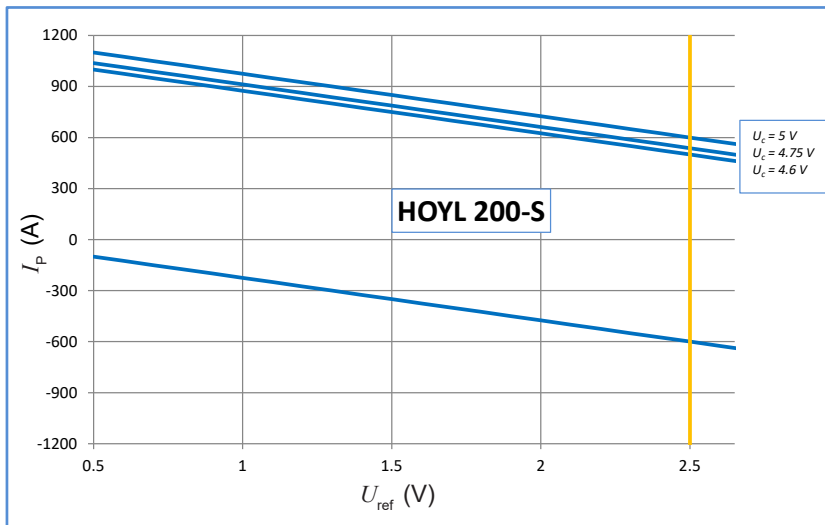

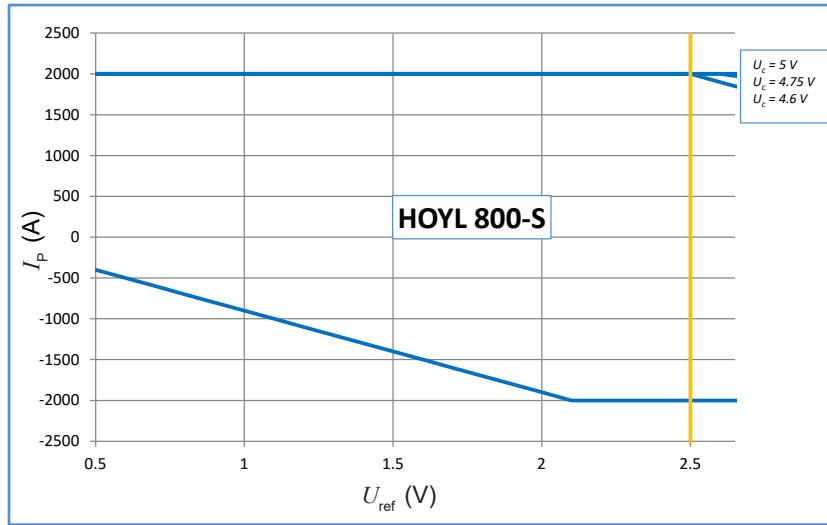

**Measuring range versus external reference voltage**

**Maximum continuous DC current**

For all ranges:

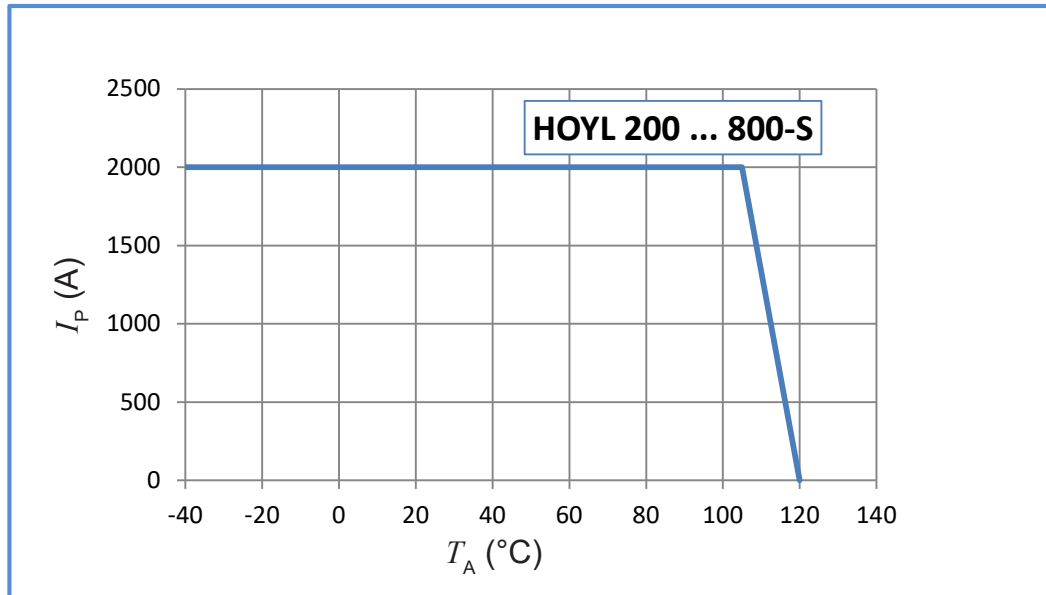

**Important notice:** whatever the usage and/or application, the transducer primary bar / jumper temperature shall not go above the maximum rating of 120 °C as stated in page 2 of this datasheet.

**HOYL-S series: name and codification**

HOYL-S family products may be ordered **on request**<sup>1)</sup> with a dedicated setting of the parameters as described below (standard products are delivered with the setting 0100 according to the table).

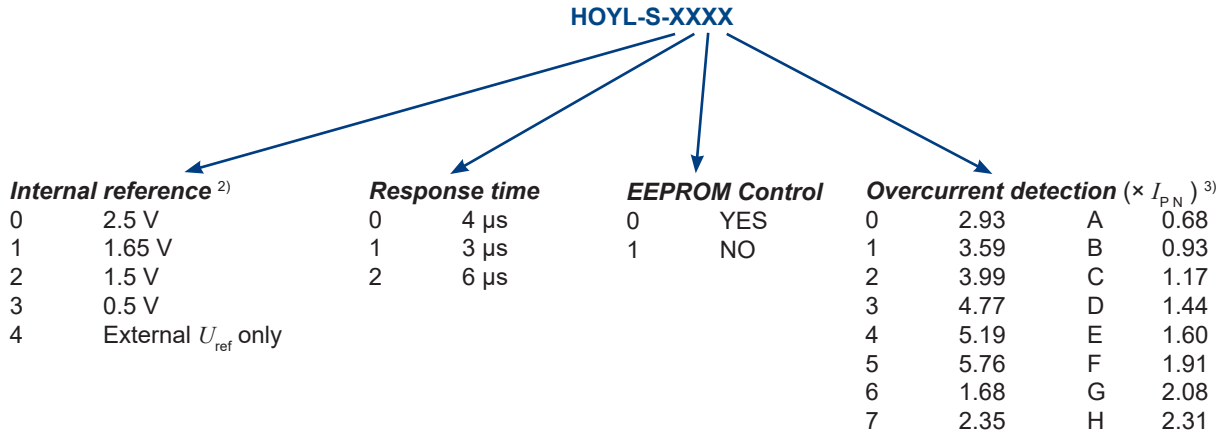

**Notes:** <sup>1)</sup> For dedicated settings, minimum quantities apply, please contact your local LEM support

<sup>2)</sup>  $U_{ref}$  electrical data

$U_{ref}$ parameter	$U_{ref}$ (V)			$TCU_{ref}$ (ppm/K)	
	min	typ	max	min	max
0	2.48	2.5	2.52	-170	170
1	1.63	1.65	1.67	-170	170
2	1.48	1.5	1.52	-170	170
3	0.49	0.5	0.51	-250	250

<sup>3)</sup> OCD ( $\times I_{PN}$ ) correction table versus range and temperature.  
All other values or empty cells: no change

HOYL-S-010x				
OCD Parameter	200	400	600	800
A				
B				
C				
D				
E				
6				
F				
G				
H				
7				
0				
1				
2				
3				7.06
4				-
5			6.03	-

Tolerance on OCD value	
$\pm 20\%$	
$\pm 15\%$	
$\pm 10\%$	No change
-	Do not use

## Application information

HOYL-S series is designed to be used with a bus-bar or cable <sup>1)</sup> to carry the current through the aperture with a maximum cross-section of 40 × 13 mm.

**Note:** <sup>1)</sup> The maximum magnetic offset referred to primary is inversely proportional to the number of turns, thus is divided by 2 with 2 turns.

## Definition of typical, minimum and maximum values

Minimum and maximum values for specified limiting and safety conditions have to be understood as such as well as values shown in "typical" graphs.

On the other hand, measured values are part of a statistical distribution that can be specified by an interval with upper and lower limits and a probability for measured values to lie within this interval.

Unless otherwise stated (e.g. "100 % tested"), the LEM definition for such intervals designated with "min" and "max" is that the probability for values of samples to lie in this interval is 99.73 %.

For a normal (Gaussian) distribution, this corresponds to an interval between -3 sigma and +3 sigma. If "typical" values are not obviously mean or average values, those values are defined to delimit intervals with a probability of 68.27 %, corresponding to an interval between -sigma and +sigma for a normal distribution. Typical, minimum and maximum values are determined during the initial characterization of the product.

## Remark

Installation of the transducer must be done unless otherwise specified on the datasheet, according to LEM Transducer Generic Mounting Rules. Please refer to LEM document N°ANE120504 available on our Web site: <https://www.lem.com/en/file/3137/download/>.

## Safety

This transducer must be used in limited-energy secondary circuits according to IEC 61800-5-1.



This transducer must be used in electric/electronic equipment with respect to applicable standards and safety requirements in accordance with the manufacturer's operating instructions.



Caution, risk of electrical shock

When operating the transducer, certain parts of the module can carry hazardous voltage (eg. primary busbar, power supply). Ignoring this warning can lead to injury and/or cause serious damage. This transducer is a build-in device, whose conducting parts must be inaccessible after installation. A protective housing or additional shield could be used. Main supply must be able to be disconnected.

**Insulation distance (nominal values):**

	$d_{cp}$	$d_{cl}$
Between primary busbar and secondary pins	24.3 mm	24.3 mm
Between primary busbar and core	21.1 mm	-
Between core and secondary terminal	12.3 mm	12.3 mm

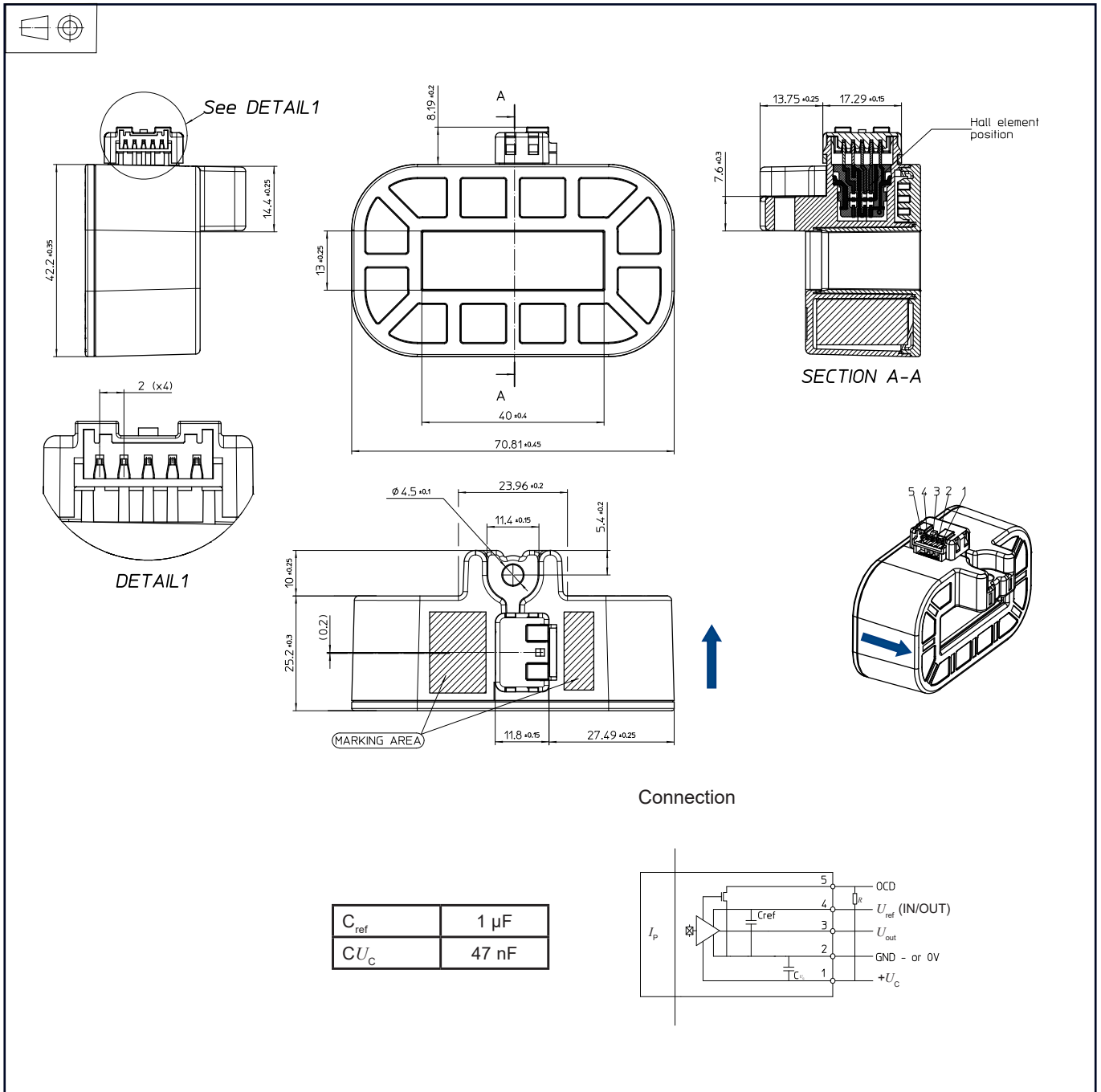
**Dimensions** (mm, general linear tolerance  $\pm 0.3$  mm)

**Remarks:**

- $U_{out}$  is positive with respect to  $U_{ref}$  when positive  $I_p$  flows in direction of the arrow shown on the drawing above.
  - Connection system equivalent to JST B05B-PASK.
  - Transducer fastening
    - 1 hole  $\varnothing$  4.5 mm
    - 1 steel screw M4
- Recommended fastening torque      4 N·m