

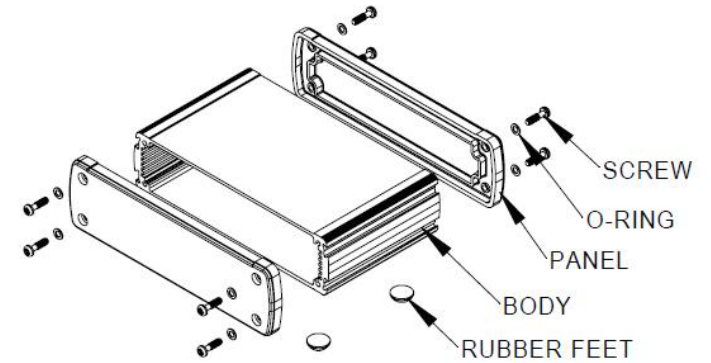

RS Stock No.13689330001
RS Stock No.13689340001
RS Stock No.13689350001
RS Stock No.13689360001
RS Stock No.13689370001
RS Stock No.13689380001
RS Stock No.13689390001
RS Stock No.13689400001

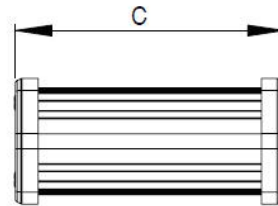

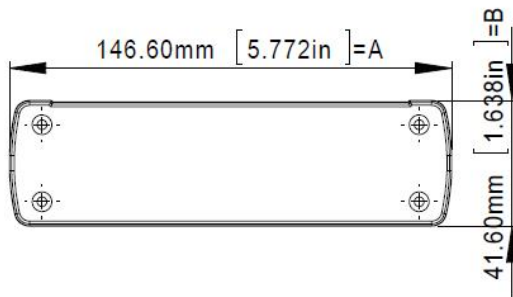
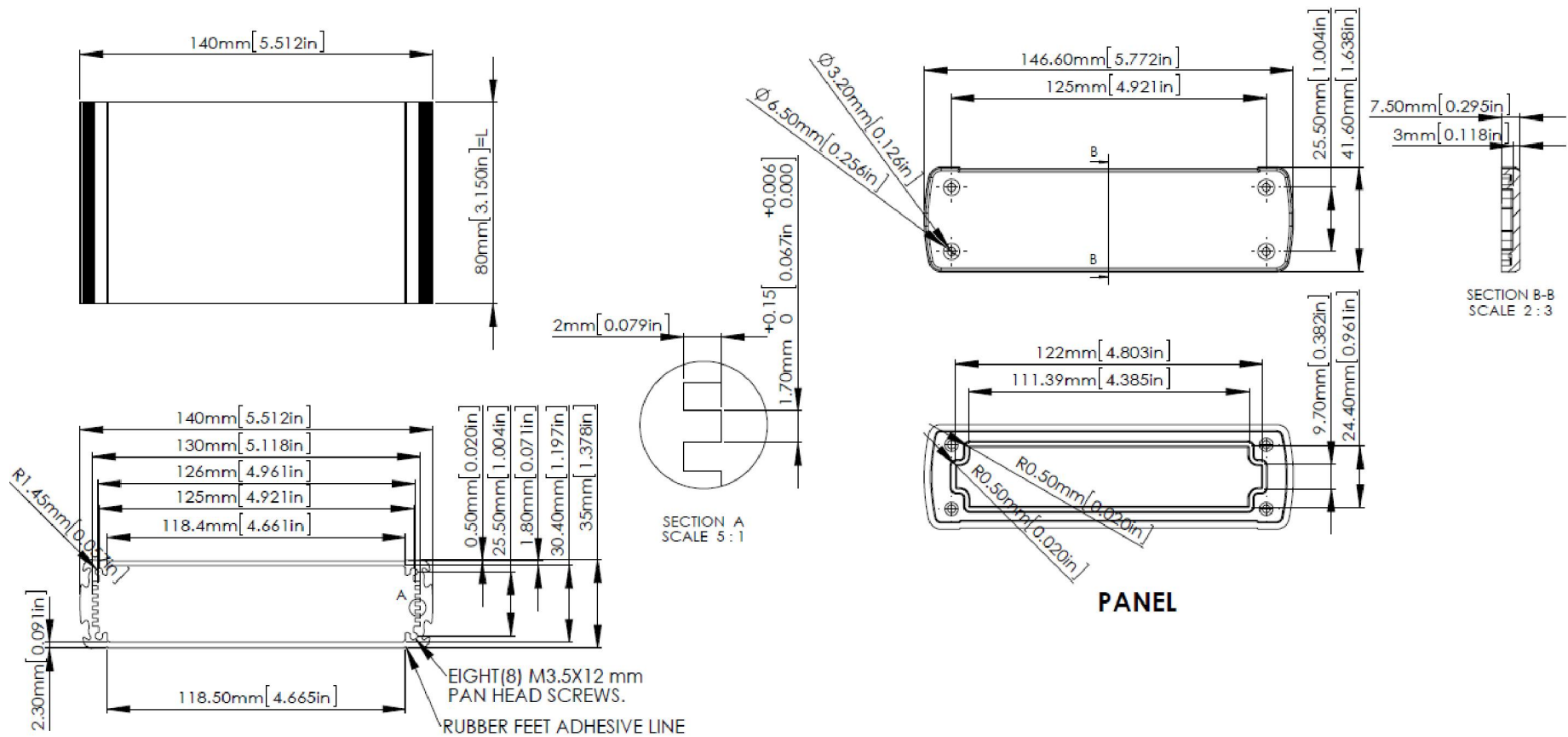

ITEM NO.	L(mm)
13689330001	80mm
13689340001	120mm
13689350001	160mm
13689360001	200mm
13689370001	80mm
13689380001	120mm
13689390001	160mm
13689400001	200mm

According to ISO 2768-m	
Measuring DIM=L	Tolerances
0.5<L<=3.0mm	±0.1mm
3.0<L<=6.0 mm	±0.1mm
6.0<L<=30.0 mm	±0.2mm
30.0<L<=120.0 mm	±0.3mm
120.0<L<=400.0 mm	±0.5mm
400.0<L<=1000.0 mm	±0.8mm