

# 868MHz LORA/LPWA/ISM WHIP



AEACAQ190012-S868



190.0 x Ø12.9 mm  
RoHS/RoHS II Compliant

MSL = N/A: NOT APPLICABLE

## FEATURES

- Gain of 3.5dBi
- 10W input power
- Designed for 868 MHz
- $VSWR \leq 2.0$
- 190 x Ø12.9mm form factor

## APPLICATIONS

- LPWA
- LoRA
- Sigfox
- ISM Applications
- Remote Technology/Monitoring
- Network devices
- Smart buildings
- Smart cities
- M2M
- Agriculture / Environment
- Consumer tracking

## EXTERNAL ANTENNA

Parameters	Min.	Typ.	Max.	Units	Note
Frequency Range		868		MHz	
Bandwidth		CF ± 8MHz			
VSWR			2.0		
Polarization Model		Linear			
Impedance		50		Ω	
Gain		3.5		dBi	
Operating Temperature	-40		+85	°C	
Input Power			10	W	

## RETURN - LOSS CHARACTERSTICS

### S11 Return-Loss

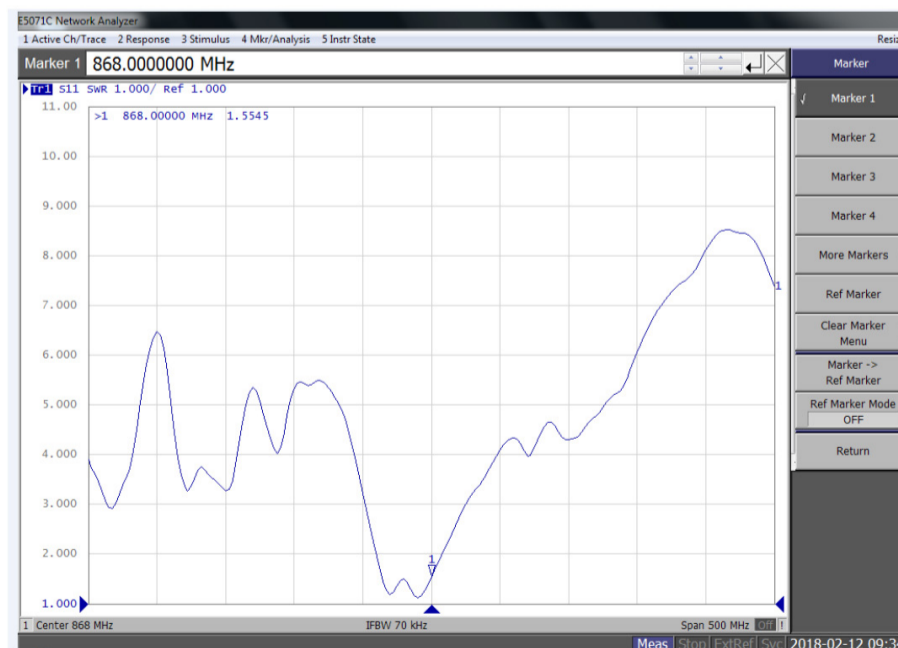

# 868MHz LORA/LPWA/ISM WHIP

AEACAQ190012-S868



190.0 x Ø12.9 mm



RoHS/RoHS II Compliant

MSL = N/A: NOT APPLICABLE

## RADIATION PATTERNS

### Antenna 2D Patterns

Vertical Plane

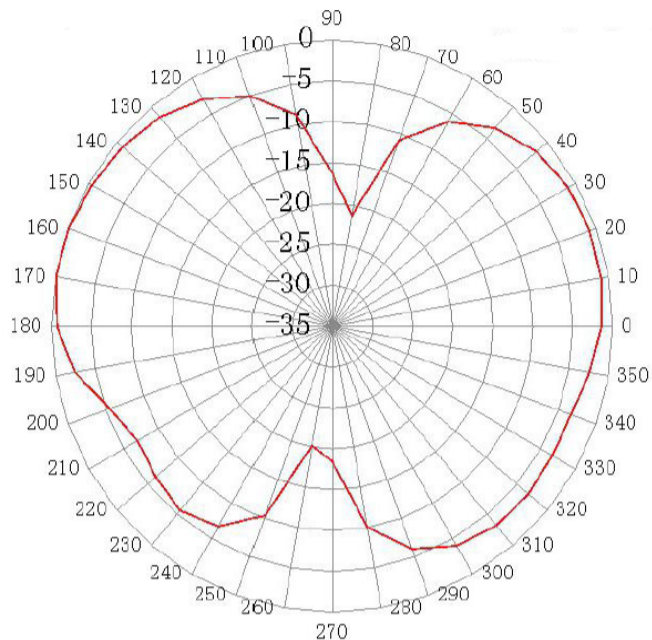

Horizontal Plane

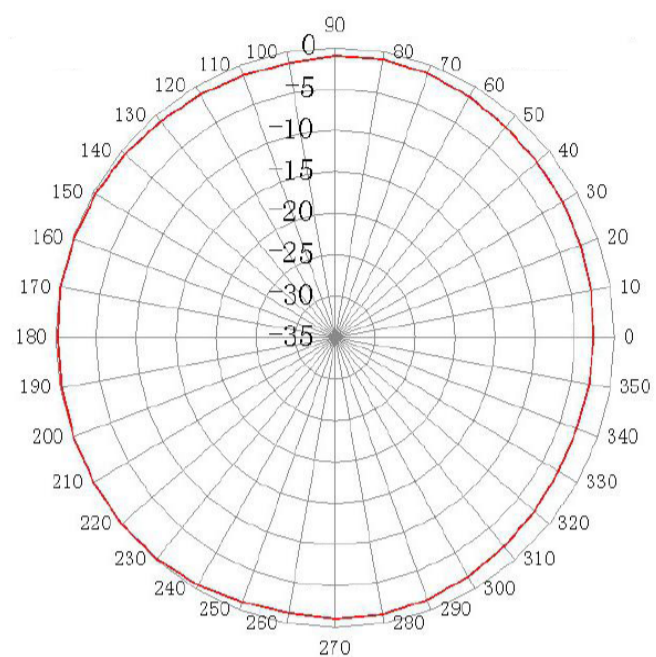

### Antenna 3D Pattern

868 MHz

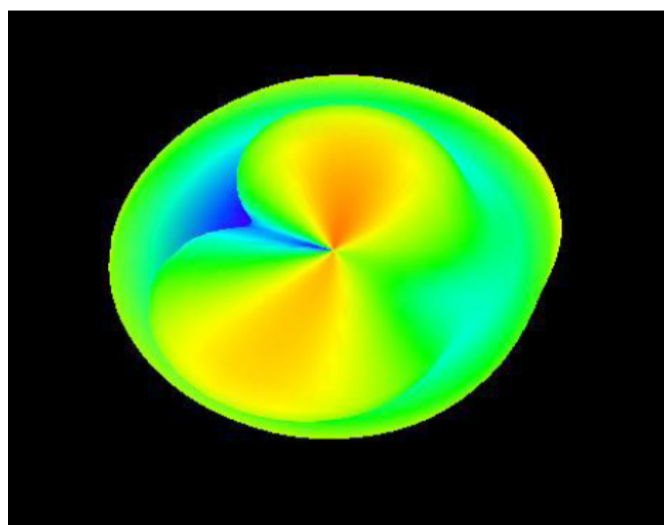

Frequency (MHz)	868
Peak Gain (dBi)	3.50
Efficiency (%)	56

# 868MHz LORA/LPWA/ISM WHIP

AEACAQ190012-S868



190.0 x Ø12.9 mm  
RoHS/RoHS II Compliant

MSL = N/A: NOT APPLICABLE

## DIMENSIONS

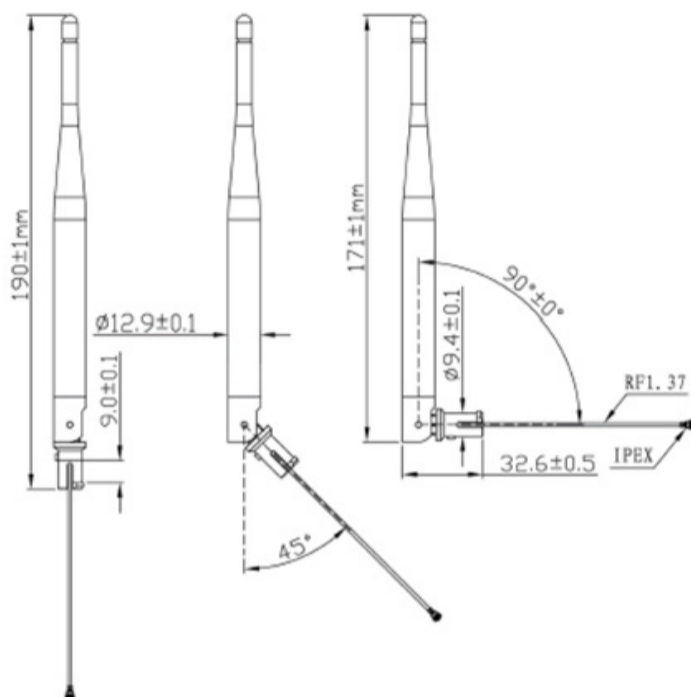

Parameters	Description
Cable Length	10.0 cm
RF Cable	RG178/RF1.37 or others
RF Connector	IPEX or others
Mounting Type	Knuckle

## PACKAGING:

Each 495 x 225 x 270 mm size carton includes 500 pcs antenna, 13kgs/carton.

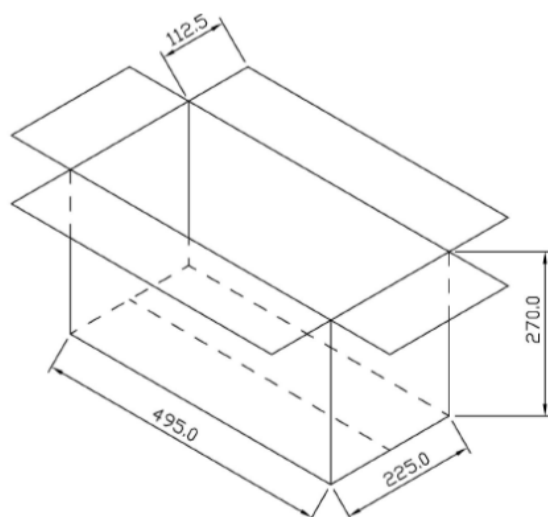

Unit: mm

