

- DIN Rail mounting enclosure to suit varying electronic and electrical applications
- The enclosure has two high shoulders offering increased volume for components
- Openings for inputs/outputs can be cost effectively machined to customer specific requirements.
- Top panel is produced as part of the mould (non-removeable)
- Customisation options are available including machining and/or printing to customer specific requirements

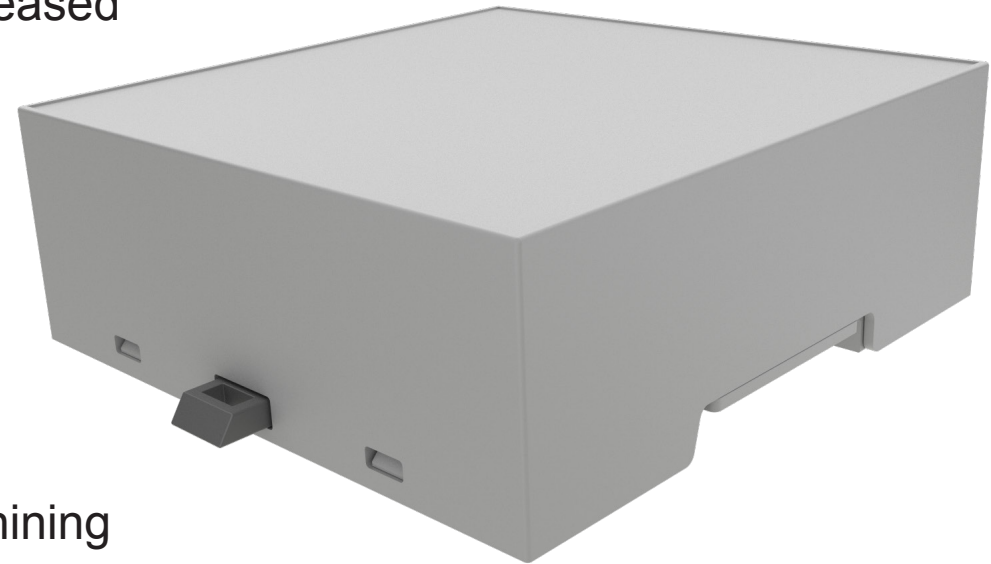

Dimension of PCB



B-B (1 : 1)

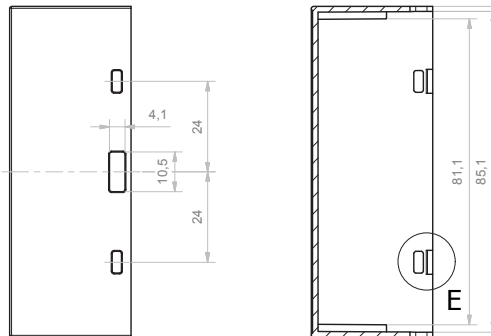

Body enclosure

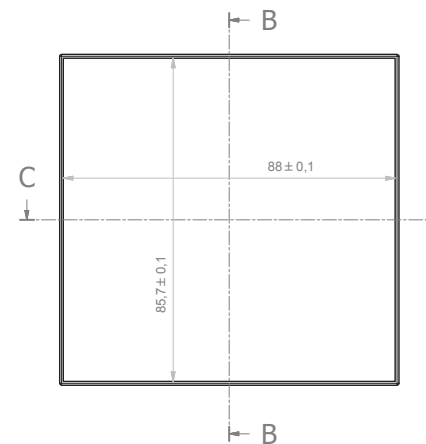

Assembly

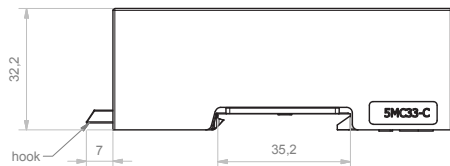

E (2 : 1)

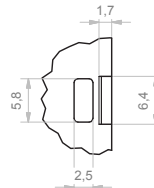

C-C (1 : 1)

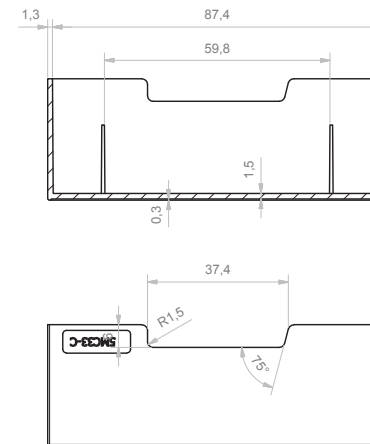

A

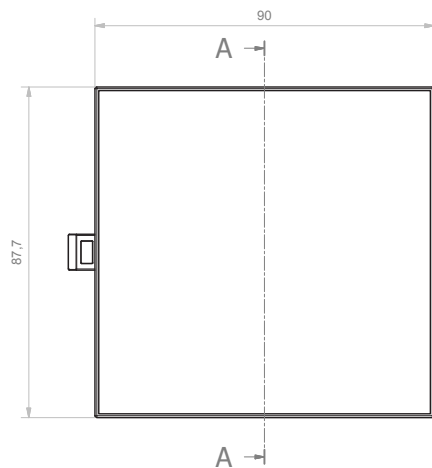

A-A (1 : 1)

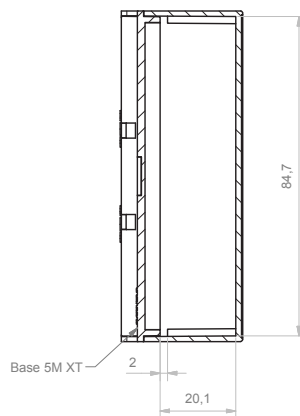

Da 0,5 a 3	Oltre 3 fino a 6	Oltre 6 fino a 30	Oltre 30 fino a 120	Oltre 120	
± 0,1	± 0,1	± 0,2	± 0,3	± 0,5	
RESERVED PROPERTY The present drawing cannot be reproduced or communicated to 3d parties, even partially, without the authorization of ITALTRONIC S.p.A. Italtronic reserves to protect its own rights according to the law.		Dimension in mm	SHEET NR. 1 / 1	DRAWING BY Manual modification are not allowed	GENERAL TOLERANCE UNI EN 22768/1 Media (m)
Date:	19/05/2014		Replace nr.	Revision description	
Drawed:	Rigato N.	Checked:	Dalla Montà D.	Scale:	

Hitalttech
A group of connecting technologies
Italtronic S.p.A.
...the value container

Denomination:
Contenitore Modulbox XTS 5MC33-C chiuso compact
Enclosure Modulbox XTS 5MC33-C closed compact

ITALTRONIC S.R.L.
VIA AUSTRIA 25/D 35127
PADOVA - ITALY
www.italtronic.com

Drawing nr.
M-05178-00

5 4 3 2 1