

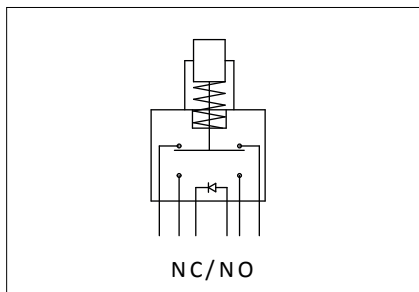

AV series

Security pushbutton switches Ø19mm (.748) With illuminated ring - momentary (NC/NO) - Black Chrome Finish



ORDER FORMAT

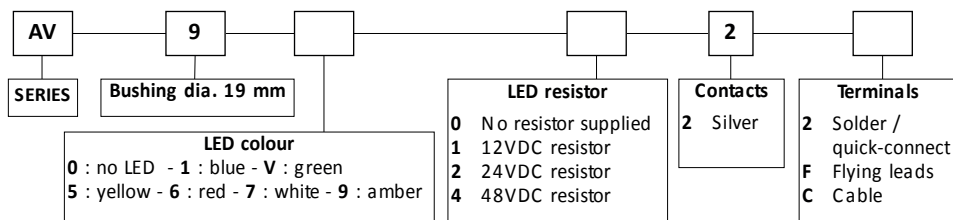

SPECIFICATIONS

- Travel : 2 mm ± 0,3 mm (.003)
- Max. current/ voltage rating with resistive load : 1A 30VDC
- LED voltage : 12VDC, 24VDC or 48VDC
(If not supplied by APEM, a resistor must be series-connected by the user)**
- Initial contact resistance : 100 mΩ max.
- Insulation resistance : 10 MΩ min. at 500VDC
- Dielectric strength : 500 Vrms 50 Hz min. between terminals
1.000 Vrms 50 Hz min. between terminals and frame
- Electrical life : 250.000 cycles at full load
- Operating force : 5 N ± 2N
- Torque : 5 Nm min.- 14 Nm max. applied to nut
- Panel thickness : 1 (.039) to 6 mm (.236) max.
- Low level or mechanical life : 1.000.000 cycles
- Operating temperature : -30°C to +85°C
- Hand soldering : 350°C, 5 seconds max.
- Packaging unit : flying lead/cable models : 1 piece - other models : 40 pieces

** Resistor value = $\frac{\text{supply voltage} - \text{LED forward voltage}}{\text{LED forward current}}$

MATERIALS

- Case : polyamide, glass filled
- Contacts : silver
- Bushing : see next page
- Actuator : see next page
- Elastomeric membrane : silicone
- LED

CUT-OUT

- Panel cut-out : Ø 19,2 mm (.755)
- Min. pitch for matrix mounting : 30 mm x 30 mm (1.181x1.181)

To order a product, select a basic model below and add the desired LED colour and voltage. Then select the desired options on next page.

Flat actuator - solder lug terminals

Hex nut 22 (.866) across flats



Illuminated (select LED colour above) *
AV9•022 ON - MOM

Non-illuminated
AV90022 ON - MOM

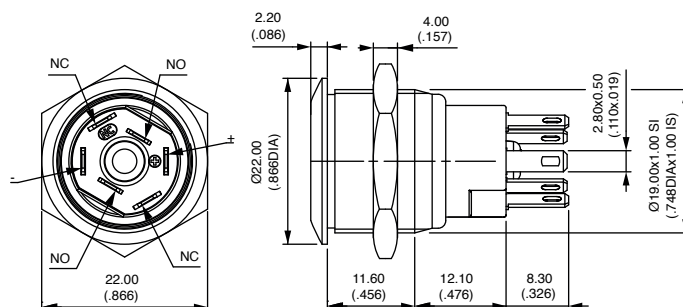

* No LED resistor supplied on this model.

Flat actuator - flying lead terminals

Hex nut 22 (.866) across flats

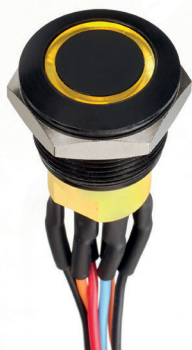

Illuminated (select LED colour & resistor above)
AV9••2F ON - MOM

Non-illuminated
AV9002F ON - MOM

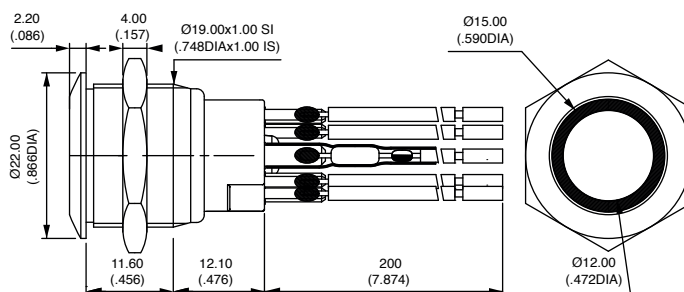

Wire colours : black : NC, orange : NO, red : LED anode (+), blue : LED cathode (-)

AV series

Security pushbutton switches Ø19mm (.748)

With illuminated ring - momentary (NC/NO) - Black Chrome Finish



Flat actuator - cable terminals

Hex nut 22 (.866) across flats



Illuminated (select colour & resistor)
AV9••2C ON - MOM

Non-illuminated
AV9002C ON - MOM

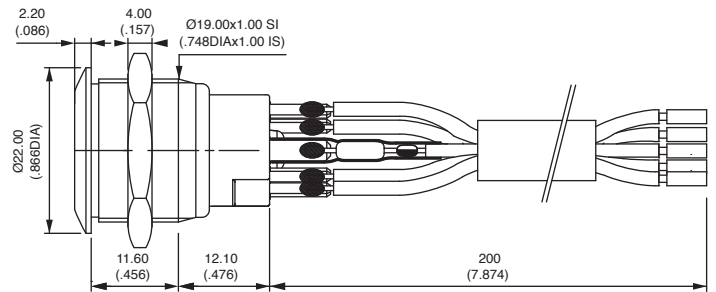

After selecting basic model No.,
 fill in last 5 boxes
 with desired options.

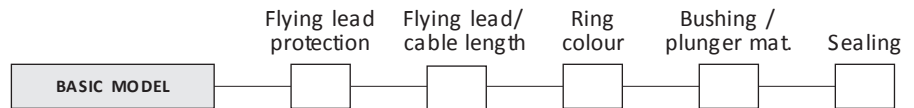

FLYING LEAD PROTECTION

- 0 No protection and/or no flying leads
- 1 Heat-shrink sleeves
- 2 Tube + epoxy

FLYING LEAD/CABLE LENGTH

- 000 No flying leads / no cable
- 020 Length 20 cm (standard)
- XXX Length in centimeters

RING COLOURS

CODE	COLOUR	CODE	COLOUR
1	Blue	6	Red
2	Black *	7	Opal white (std)
3	Green	8	Translucent
4	Grey *	9	Orange
5	Yellow		

* non-illuminated only

BUSHING/PLUNGER MATERIALS

CODE	BUSHING	ACTUATOR
70	Chrome pl. brass, black	Chrome pl. brass, black

Other : on request

SEALING

Blank No sealing



K Front panel sealing (IP67)

- ① internal membrane
- ② external gasket