

# Datasheet

## Connector Assembly

RS Stock 877-1141



### Dimensions: (mm)

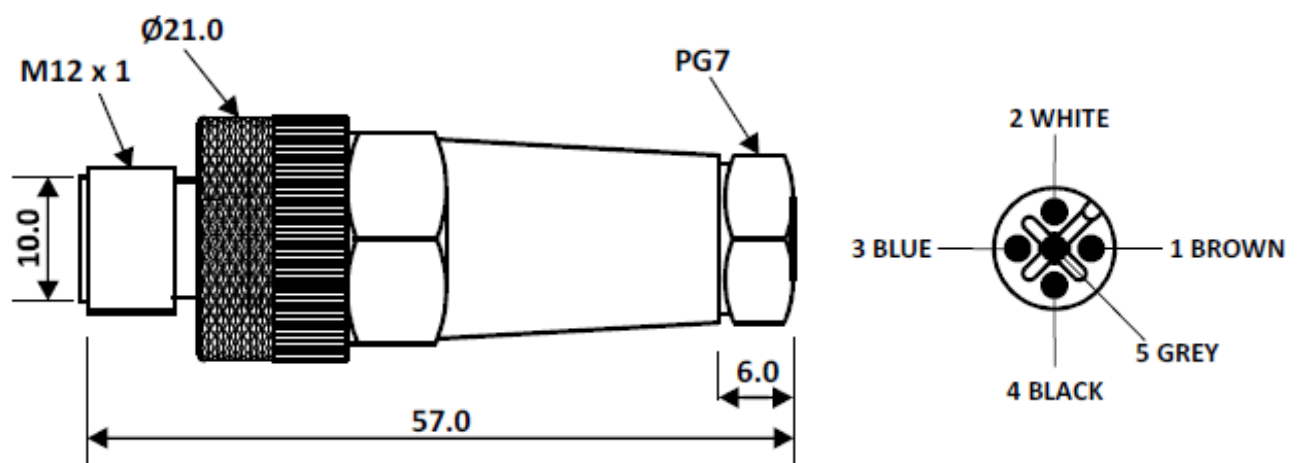

## Specifications

### General Specification

Rated Operational Voltage	60 V
Current Rating	4A
Insulation Resistance	$\geq 100 \text{ M}\Omega$
Temperature Range	-25°C ... +75°C
Degree of Protection	IP67

### Material Specification

Grip Material	Nylon 66
Contact	Cu-Zn
Contact Plating	Gold Plated
Contact Carrier	Nylon 66
O-Ring	Neoprene
Grip Colour	Black
Termination	Screw Type
Pole	5
Cable Gland	PG7
Coupling Nut	Brass Nickel-plated