

One-way flow control valves VFOF





One-way flow control valves VFOF

Key features and product range overview

Features

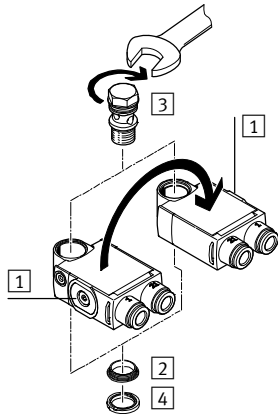
- Minimal height
- High flow rate
- Can be rotated horizontally through 360° in assembled state
- Actuation direction **1** can be changed by repositioning the housing
- Greater functionality thanks to function combinations





 Note

The following sequence must be observed when assembling the individual components:

- 1) Press thrust ring **2** into the housing until it fits tightly.
- 2) Insert hollow bolt **3** into the opening.
- 3) Push sealing ring OK **4** over the thread of the hollow bolt.

Product range overview

Function	Valve function	Design	Type	Pneumatic connection 1	Pneumatic connection 2	qnN ¹⁾ [l/min]	Adjusting element	→ Page/ Internet
One-way flow control valves	Standard							
	Exhaust air one-way flow control function		VFOF	QS-6, QS-8	G1/8, G1/4	250 ... 650	Internal hex	3
	Function combination							
	Exhaust air one-way flow control function		VFOF	QS-6, QS-8	G1/8, G1/4	240 ... 590	Internal hex	6

1) Standard nominal flow rate in flow control direction.

One-way flow control valves VFOF

Type codes

VFOF - L E - H - G18 - Q6



Type	
VFOF	One-way flow control valve, flat design
Design	
L	L-shaped outlet
Valve function	
E	Exhaust air one-way flow control function
Adjusting element	
H	Internal hex
Pneumatic connection 2	
G18	Thread G $\frac{1}{8}$
G14	Thread G $\frac{1}{4}$
Pneumatic connection 1	
Q6	Push-in connector QS-6
Q8	Push-in connector QS-8

One-way flow control valves VFOF

Technical data

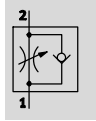
One-way flow control function
Exhaust air



-  - Standard nominal flow rate
250 ... 650 l/min
-  - Temperature range
-10 ... +60 °C
-  - Operating pressure
0.2 ... 10 bar



One-way flow control valves are used to adjust the flow rate and produce a specific change in the piston speed during the advance and return stroke

when used with pneumatic drives. This is done through suitable restriction of the flow rate of

compressed air. The flow control function is realised by means of an adjustable annular gap in

the housing. This gap can be increased or decreased by turning the regulating screw with internal hex.

General technical data		
Valve function	Exhaust air one-way flow control function	
Pneumatic connection 2	G1/8	G1/4
Pneumatic connection 1	QS-6	QS-8
Adjusting element	Internal hex	
Actuation type	Manual	
Type of mounting	Screw-in	
Mounting position	Any	
Nominal tightening torque [Nm]	3 ±20%	11 ±20%
Perm. actuation torque for regulating screw [Nm]	1	1.5
Rotatability [°]	360 (continuous rotation not permitted)	

Operating and environmental conditions		
Operating pressure [bar]	0.2 ... 10	
Operating/pilot medium	Compressed air according to ISO 8573-1:2010 [7:4:4]	
Note on operating/pilot medium	Lubricated operation possible (in which case lubricated operation will always be required)	
Ambient temperature [°C]	-10 ... +60	
Temperature of medium [°C]	-10 ... +60	
Storage temperature [°C]	-20 ... +70	
Corrosion resistance class CRC ¹⁾	2	

1) Corrosion resistance class CRC 2 to Festo standard FN 940070
Moderate corrosion stress. Indoor applications in which condensation may occur. External visible parts with primarily decorative requirements for the surface and which are in direct contact with the ambient atmosphere typical for industrial applications.

Materials

Sectional view

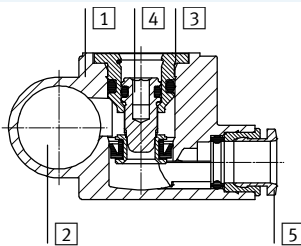

One-way flow control valve		
1	Housing	PBT
2	Hollow bolt	Wrought aluminium alloy
3	Sleeve	Wrought aluminium alloy
4	Regulating screw	Brass
5	Releasing ring	POM
-	Seals	NBR
Note on materials		RoHS-compliant

One-way flow control valves VFOF

Technical data

Standard nominal flow rate q_{nN} [l/min] and standard flow rate q_n [l/min] as a function of turns of the adjusting screw n

VFOF-...-G18-Q6

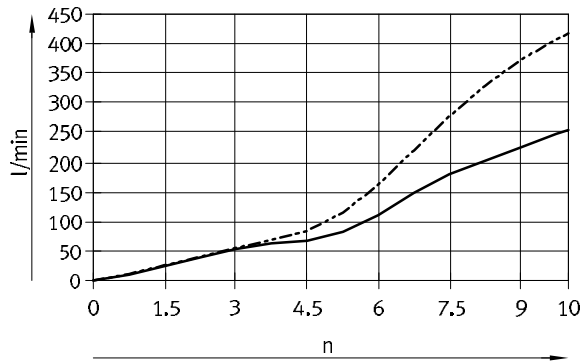

VFOF-...-G14-Q8

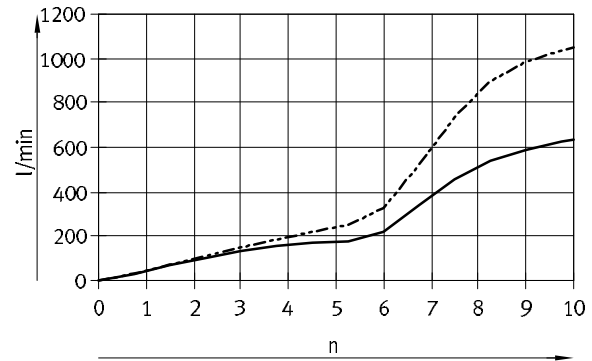

— q_{nN} Flow rate value tolerance: $\pm 20\%$
 - - - q_n

Dimensions

Download CAD data → www.festo.com

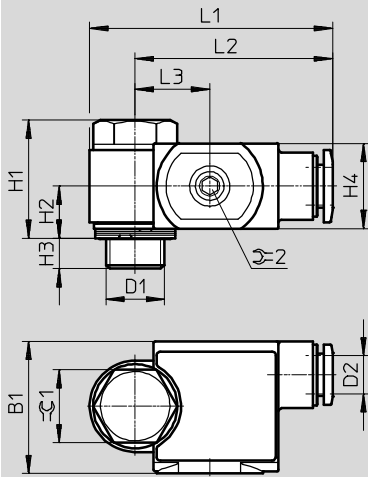

Type	Connection D1	Tubing O.D. D2	B1	H1	H2	H3	H4	L1	L2	L3	⌀1	⌀2
VFOF-...-G18-Q6	G1/8	QS-6	21.7	19.4	8.6	5	14	39.9	32.4	12.2	12	2.5
VFOF-...-G14-Q8	G1/4	QS-8	24.7	28.4	12.6	5.4	19.6	56.3	46.1	15.5	15	2.5

Ordering data – Exhaust air one-way flow control function

	Pneumatic connection		Standard nominal flow rate q_{nN} at 6 bar → 5 bar		Standard flow rate q_n at 6 bar → 0 bar		Weight [g]	Part No.	Type
			In flow control direction	In non-return direction	In flow control direction	In non-return direction			
			2	1	[l/min]	[l/min]			
	G1/8	QS-6	250	150 ... 260	420	460 ... 540	13.9	1526931	VFOF-LE-H-G18-Q6
	G1/4	QS-8	650	300 ... 650	1,100	840 ... 1,100	32.9	1505391	VFOF-LE-H-G14-Q8

One-way flow control valves VFOF, function combination

Type codes

VFOF - L E - BA H - G18 - Q6



Type	
VFOF	One-way flow control valve, flat design
Design	
L	L-shaped outlet
Valve function	
E	Exhaust air one-way flow control function
Additional function	
BA	Piloted non-return function, manual exhaust function
Adjusting element	
H	Internal hex
Pneumatic connection 2	
G18	Thread G1/8
G14	Thread G1/4
Pneumatic connection 1	
Q6	Push-in connector QS-6
Q8	Push-in connector QS-8

One-way flow control valves VFOF, function combination

Technical data

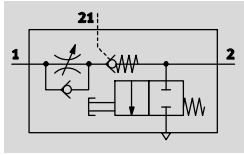
One-way flow control function
Exhaust air



-  - Standard nominal flow rate
240 ... 590 l/min
-  - Temperature range
-10 ... +60 °C
-  - Operating pressure
0.2 ... 10 bar



The one-way flow control valve VFOF-LE-BAH is a valve with a function combination consisting of an exhaust air one-way flow control function and a piloted non-return function with manual exhaust function.

The exhaust air one-way flow control

function is used to manually adjust the advance/return speed of the piston rod of a pneumatic drive. The flow control function is realised by means of an adjustable annular gap in the housing. This gap can be

increased or decreased by turning the regulating screw with internal hex. The piloted non-return function can be used for a temporary intermediate stop. If a pilot signal is applied, exhaust air flow control is no

pilot signal is applied, the valve shuts off the exhaust air from the drive and the drive stops temporarily. The integrated manual exhaust function can be used to manually vent a pneumatic drive.

General technical data			
Valve function		Exhaust air one-way flow control function	
Pneumatic connection 2		G1/8	G1/4
Pneumatic connection 1		QS-6	QS-8
Pilot air connection 21		QS-6	QS-8
Adjusting element		Internal hex	
Actuation type		Manual	
Type of actuation, piloted non-return function		Pneumatic	
Manual exhaust function		Non-detenting	
Type of mounting		Screw-in	
Mounting position		Any	
Switching time	Off	[ms]	9
	On	[ms]	6
Nominal tightening torque		[Nm]	3 ±20%
			11 ±20%
Perm. actuation torque for regulating screw		[Nm]	1
Rotatability		[°]	360 (continuous rotation not permitted)

Operating and environmental conditions			
Operating pressure for entire temperature range	[bar]	0.2 ... 10	
Pilot pressure	[bar]	2 ... 10	
Operating/pilot medium		Compressed air according to ISO 8573-1:2010 [7:4:4]	
Note on operating/pilot medium		Lubricated operation possible (in which case lubricated operation will always be required)	
Ambient temperature	[°C]	-10 ... +60	
Temperature of medium	[°C]	-10 ... +60	
Storage temperature	[°C]	-20 ... +70	
Corrosion resistance class CRC ¹⁾		2	

1) Corrosion resistance class CRC 2 to Festo standard FN 940070
Moderate corrosion stress. Indoor applications in which condensation may occur. External visible parts with primarily decorative requirements for the surface and which are in direct contact with the ambient atmosphere typical for industrial applications.

One-way flow control valves VFOF, function combination

Technical data

Materials

Sectional view

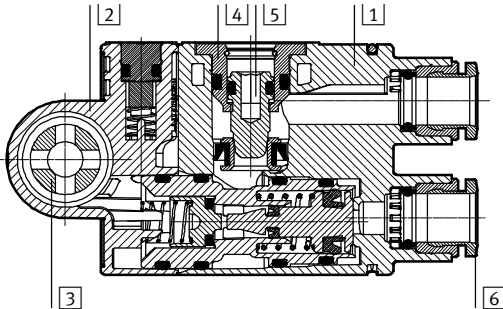

One-way flow control valve

1	Housing	PBT
2	End cap	PBT
3	Hollow bolt	Wrought aluminium alloy
4	Sleeve	Wrought aluminium alloy
5	Regulating screw	Brass
6	Releasing ring	POM
-	Cover	ES-BE
-	Seals	NBR
Note on materials		RoHS-compliant

Standard nominal flow rate q_{nN} in flow control direction at 6 \rightarrow 5 bar as a function of turns of the adjusting screw n

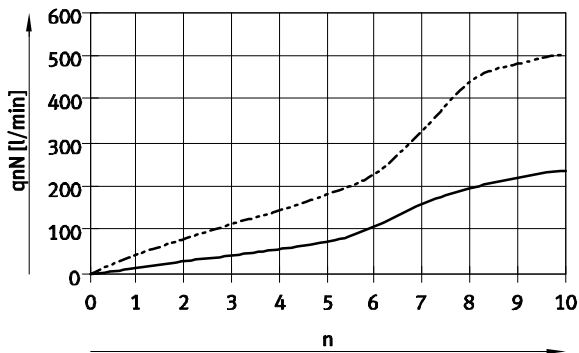

— VFOF-...-G18-Q6 Flow rate value tolerance: $\pm 20\%$
 - - - VFOF-...-G14-Q8

Standard flow rate q_n in flow control direction at 6 \rightarrow 0 bar as a function of turns of the adjusting screw n

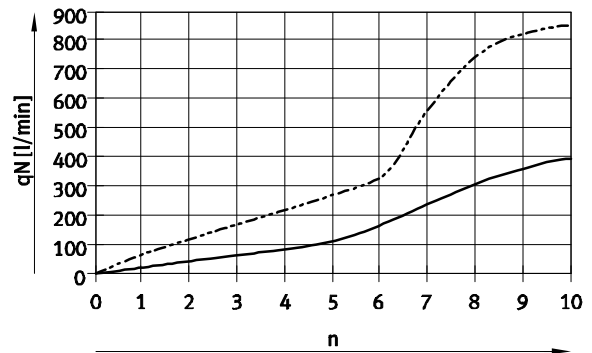

— VFOF-...-G18-Q6 Flow rate value tolerance: $\pm 20\%$
 - - - VFOF-...-G14-Q8

Minimum pilot pressure p_{21} as a function of operating pressure p_1



One-way flow control valves VFOF, function combination

Technical data

Dimensions

Download CAD data → www.festo.com

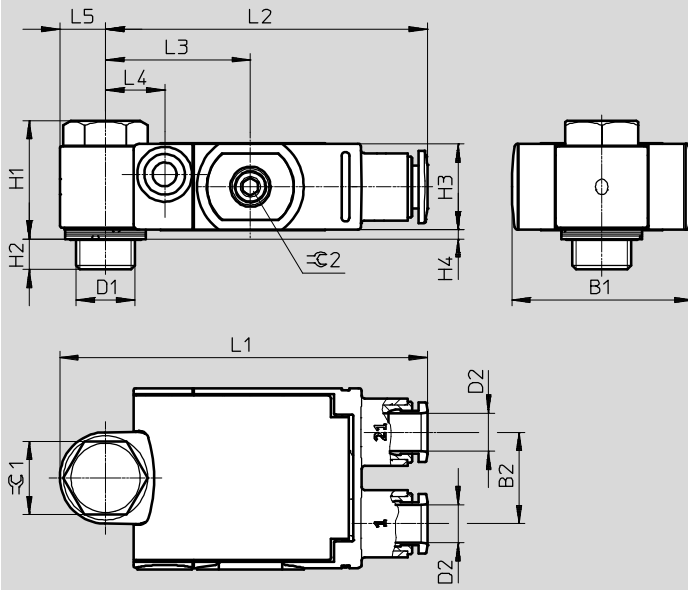

Type	Connection D1	Tubing O.D. D2	B1	B2	H1	H2	H3	H4	L1	L2	L3	L4	L5	⌀ 1	⌀ 2
VFOF...-G18-Q6	G1/8	QS-6	29.5	15	19.4	5	14.1	1.5	60.3	52.8	23.8	9.7	7.5	12	2.5
VFOF...-G14-Q8	G1/4	QS-8	39.5	20.5	28.2	5.6	21	2	76.8	66.8	30	11.1	10	15	2.5

Ordering data – Exhaust air one-way flow control function

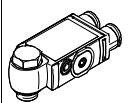
	Pneumatic connection		Pilot air connection	Standard nominal flow rate q _N at 6 bar → 5 bar		Standard flow rate q _n at 6 bar → 0 bar		Weight [g]	Part No.	Type
	2	1		In flow control direction	In non-return direction	In flow control direction	In non-return direction			
				[l/min]	[l/min]	[l/min]	[l/min]			
	G1/8	QS-6	QS-6	240	150 ... 230 120 ... 220 ¹⁾	420	400 ... 460 400 ... 460 ¹⁾	28.6	8001459	VFOF-LE-BAH-G18-Q6
	G1/4	QS-8	QS-8	590	315 ... 540 310 ... 540 ¹⁾	940	830 ... 1,000 840 ... 1,000 ¹⁾	73.9	1927030	VFOF-LE-BAH-G14-Q8

1) Unactuated