

FEATURES

- Compact Mounting
- High Performance
- Single Phase Input
- Reliable
- Led Indicators

RS PRO DIN Rail Power Supply - 230V ac Input Voltage, 24V dc Output Voltage, 5A Output Current, 120W

RS Stock No.: 136-8320



RS Professionally Approved Products bring to you professional quality parts across all product categories. Our product range has been tested by engineers and provides a comparable quality to the leading brands without paying a premium price.

Product Description

From RS Pro a range of high-performance power supplies in a compact 35mm DIN rail mounting package for convenience and space saving. These DIN rail mount power supplies are available with a range of power ratings from 15W to 240W and accept single-phase AC input for conversion into a single DC output of either 12V, 15V, 24V or 48V DC.

General Specifications

Type	Switch Mode
AC or DC Input Voltage	230VAC
AC or DC Output Voltage	48VDC
Number of Outputs	1
Special Features	Compact Size, Cooling by Free Air Convection, LED Indicator for DC Low, LED Indicator for DC Power On, 3-Years Warranty, 100% Full Load Burn-In Test
Mounting Type	DIN Rail, Vertical Mount
Short Circuit Protection	Yes
Over Voltage Protection	Yes
Indication of Output Voltage	LED, Continuous Green Light
Applications	Sensors, Transmitters/receivers, Analyzers, PLCs Motors, Actuators, Solenoids, Relays

Electrical Specifications

RS Stock#	Input Voltage	Output Voltage	Output Current	Output Wattage	Efficiency (Typ)
136-8317	100VAC-240VAC	+ 12VDC	8A	120W	82%
136-8318	100VAC-240VAC	+ 15VDC	7A	120W	82%
136-8319	100VAC-240VAC	+ 24VDC	5A	120W	85%
136-8320	100VAC-240VAC	+ 48VDC	2.5A	120W	86%

Input Specifications		
Input Electrical Phase	Single	
Input current	1.3A /230VAC	
Line Frequency	47 to 63Hz	
Inrush current at 25°C 230V	60A	
Efficiency (Typ.)	86%	
Output Specifications		
Output Voltage Adjustment	47VDC – 55VDC	
Ripple and Noise	240mV	
Hold Up Time	20ms/115VAC	
Line Regulation	2%	
Load Regulation	3%	
Voltage Isolation	Input-Output	3000VAC
	Input-Ground	1500VAC
	Output-Ground	1500VAC
Surge Voltage	2kV	
MTBF	200Khrs	

Mechanical Specifications

Height	130mm
Depth	125mm
Width	40mm
Weight	800g
Dimensions	40mm x 130mm x 125mm

Operation Environment Specifications

Operating Humidity	20% to 95% RH
Operating Temperature Range	-25 to 70°C
Storage Temperature Range	-40 to 85°C
Cooling	Free Air convection

Approvals

Standards Met	CB, CE, CUL, CULus Recognised, FCC, UL
---------------	--



Stock Number	Nominal Input Voltage	Output Voltage	Output Current	Ripple (Max.)	Efficiency (Typ.)	Certificate
136-8317	100-240VAC	12V	8A	100mV	82%	CE, FCC, CB, UL, CUL
136-8318	100-240VAC	15V	7A	120mV	82%	CE
136-8319	100-240VAC	24V	5A	120mV	85%	CE, FCC, CB, UL, CUL
136-8320	100-240VAC	48V	2.5A	240mV	86%	CE, FCC, CB, UL, CUL

Mechanical

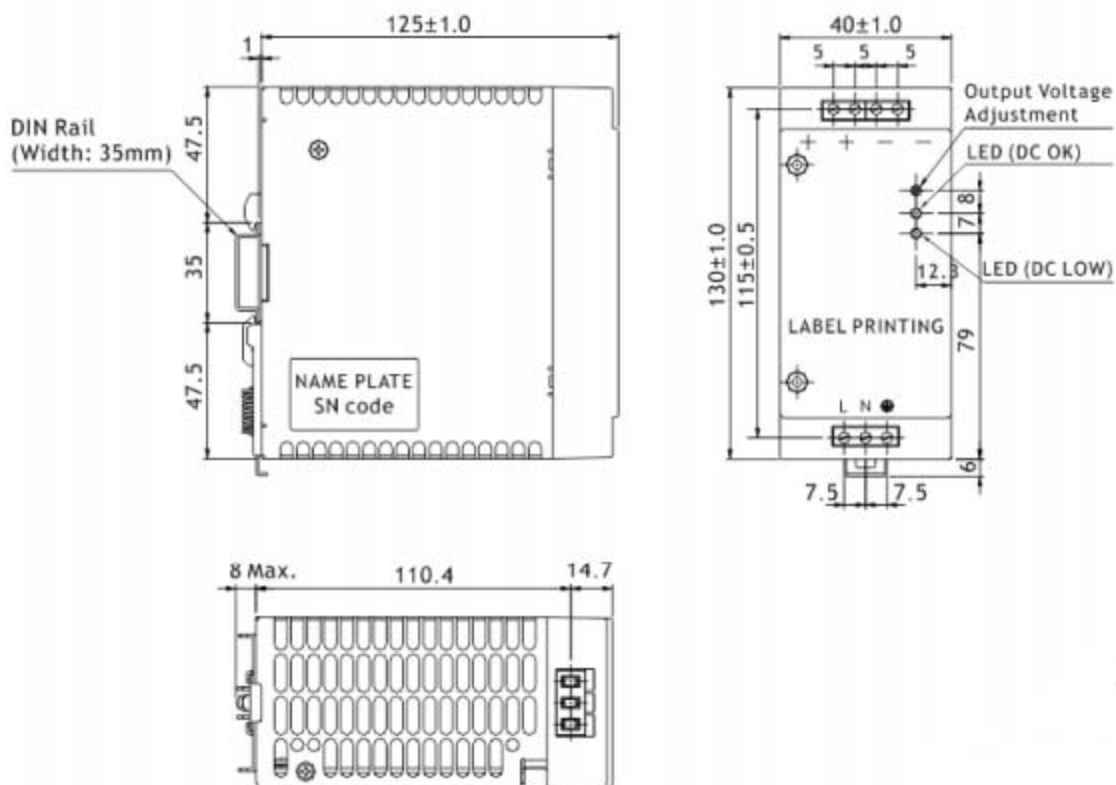



Marking	No.	Assignment
+	1	DC(+) Output Terminal
+	2	
-	3	DC(-) Output Terminal
-	4	
L	5	AC(L) Input Terminal
N	6	AC(N) Input Terminal
	7	AC Grounding Terminal
V-ADJ.	/	DC Output voltage adjustment trimmer
DC OK	/	DC Output OK indication LED(Green)
DC LOW	/	DC Output Low indication LED(Red)

Electrical Curve

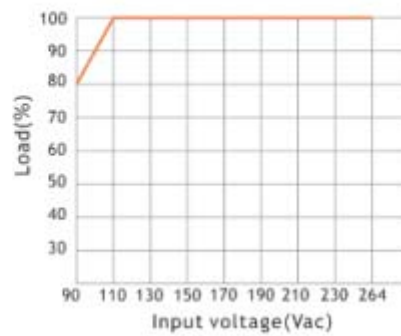
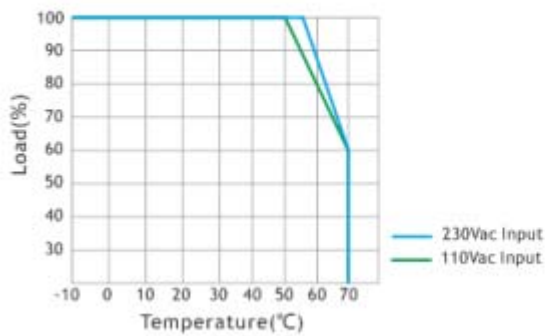

Block Diagram

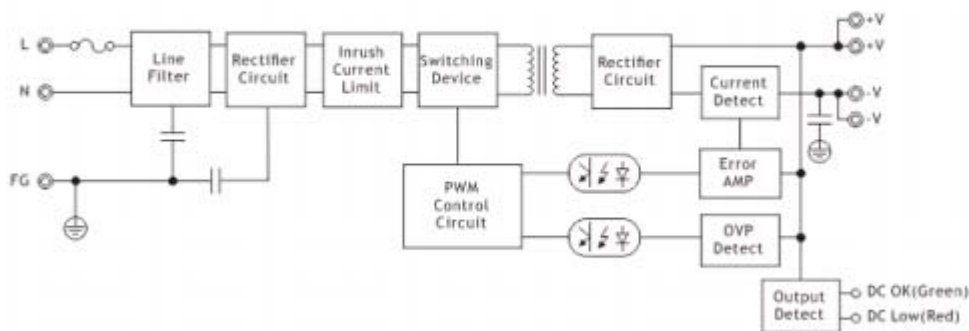

Series Operation

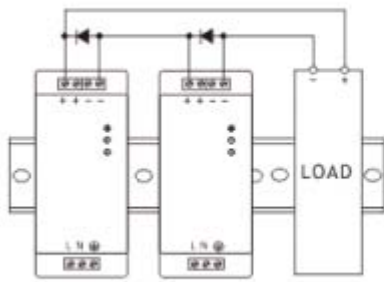

Series Operation A

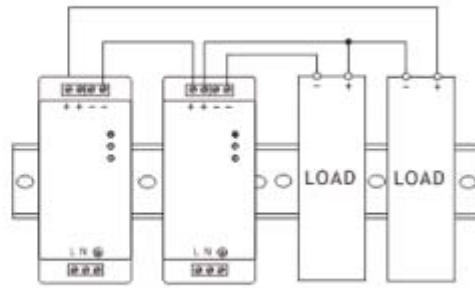

Series Operation B

Parallel Operation

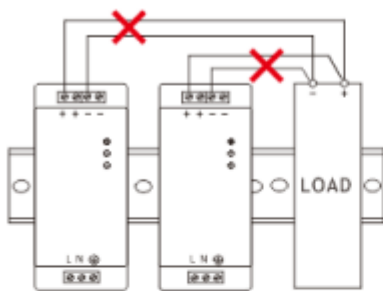

Parallel Operation A
(Unable to use)

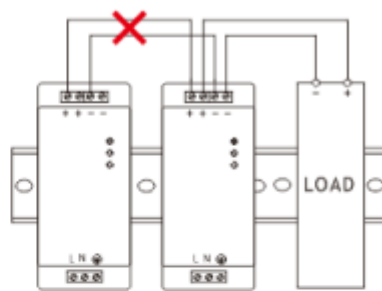

Parallel Operation B
(Unable to use)

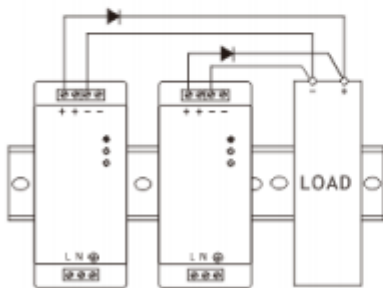

Parallel Operation C
(Backup)

Mounting Method

