

KW DMLN32.SB

SYNIOS® P2720

This compact LED device is part of the SYNIOS P2720 family. Given the scalability of this product family, it provides full performance and flexibility with just one footprint. The KW DMLN32.SB product is meant to provide superior light quality in ¼ mm² chip size class.



Applications

- Head-Up Display LED & Laser
- Interior Illumination (e.g. Ambient Map)

Features:

- Package: SMD epoxy package
- Chip technology: UX:3
- Typ. Radiation: 120° (Lambertian emitter)
- Color: Cx = 0.27, Cy = 0.25 acc. to CIE 1931 (• white)
- Corrosion Robustness Class: 3B
- Qualifications: The product qualification test plan is based on the guidelines of IEC60810, Lamps for road vehicles – Performance requirements – Requirements and test conditions for LED packages.
- ESD: 8 kV acc. to ANSI/ESDA/JEDEC JS-001 (HBM, Class 3B)

Ordering Information

Type	Luminous Flux ¹⁾ $I_F = 200 \text{ mA}$ Φ_V	Ordering Code
KW DMLN32.SB-7H6K-H5S7-PU-15B5	35.5 ... 90.0 lm	Q65112A4006

Maximum Ratings

Parameter	Symbol		Values
Operating Temperature	T_{op}	min. max.	-40 °C 125 °C
Storage Temperature	T_{stg}	min. max.	-40 °C 125 °C
Junction Temperature	T_j	max.	150 °C
Forward Current $T_s = 25\text{ °C}$	I_F	min. max.	5 mA 300 mA
Surge Current $t \leq 10\text{ }\mu\text{s}$; $D = 0.005$; $T_s = 25\text{ °C}$	I_{FS}	max.	750 mA
ESD withstand voltage acc. to ANSI/ESDA/JEDEC JS-001 (HBM, Class 3B)	V_{ESD}		8 kV
Reverse current ²⁾	I_R	max.	200 mA

Characteristics

$I_F = 200 \text{ mA}$; $T_s = 25 \text{ °C}$

Parameter	Symbol		Values
Chromaticity Coordinate ³⁾	C_x	typ.	0.27
	C_y	typ.	0.25
Peak Wavelength $I_F = 200 \text{ mA}$	λ_{peak}	min.	437.0 nm
		max.	456.0 nm
Viewing angle at 50 % I_v	2ϕ	typ.	120 °
Forward Voltage ⁴⁾ $I_F = 200 \text{ mA}$	V_F	min.	2.75 V
		typ.	2.99 V
		max.	3.50 V
Reverse voltage (ESD device)	V_{RESD}	min.	45 V
Reverse voltage ²⁾ $I_R = 20 \text{ mA}$	V_R	max.	1.2 V
Real thermal resistance junction/solderpoint ⁵⁾	$R_{\text{thJS real}}$	typ.	18 K / W
		max.	20 K / W
Electrical thermal resistance junction/solderpoint ⁵⁾ with efficiency $\eta_e = 30 \%$	$R_{\text{thJS elec.}}$	typ.	13 K / W
		max.	14 K / W

Brightness Groups

Group	Luminous Flux ¹⁾ $I_F = 200 \text{ mA}$ min. Φ_V	Luminous Flux ¹⁾ $I_F = 200 \text{ mA}$ max. Φ_V	Luminous Intensity ⁶⁾ $I_F = 200 \text{ mA}$ typ. I_v
7H	35.5 lm	40.0 lm	12.5 cd
8H	40.0 lm	45.0 lm	14.0 cd
5J	45.0 lm	50.0 lm	15.7 cd
6J	50.0 lm	56.0 lm	17.5 cd
7J	56.0 lm	63.0 lm	19.6 cd
8J	63.0 lm	71.0 lm	22.1 cd
5K	71.0 lm	80.0 lm	24.9 cd
6K	80.0 lm	90.0 lm	28.1 cd

Forward Voltage Groups

Group	Forward Voltage ⁴⁾ $I_F = 200 \text{ mA}$ min. V_F	Forward Voltage ⁴⁾ $I_F = 200 \text{ mA}$ max. V_F
15	2.75 V	3.00 V
65	3.00 V	3.25 V
B5	3.25 V	3.50 V

Peak Wavelength

Group	Peak Wavelength ⁷⁾ $I_F = 200 \text{ mA}$ min. λ_{peak}	Peak Wavelength ⁷⁾ $I_F = 200 \text{ mA}$ max. λ_{peak}
P	437.0 nm	442.0 nm
Q	439.5 nm	444.5 nm
R	442.0 nm	447.0 nm
S	445.0 nm	450.0 nm
T	448.0 nm	453.0 nm
U	451.0 nm	456.0 nm

Chromaticity Coordinate Groups ³⁾

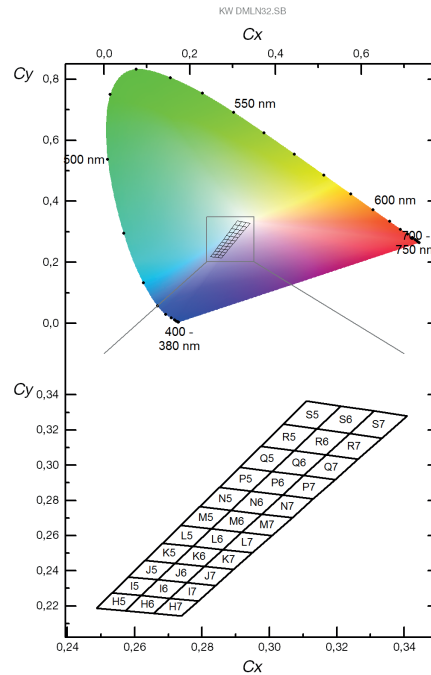

Color Chromaticity Groups ³⁾

Group	Cx	Cy	Group	Cx	Cy	Group	Cx	Cy
H5	0.2487	0.2188	I6	0.2620	0.2259	J7	0.2755	0.2332
	0.2572	0.2173		0.2705	0.2244		0.2840	0.2316
	0.2620	0.2259		0.2755	0.2332		0.2894	0.2407
	0.2533	0.2275		0.2669	0.2349		0.2807	0.2424
H6	0.2572	0.2173	I7	0.2705	0.2244	K5	0.2631	0.2459
	0.2656	0.2159		0.2789	0.2229		0.2720	0.2442
	0.2705	0.2244		0.2840	0.2316		0.2773	0.2538
	0.2620	0.2259		0.2755	0.2332		0.2683	0.2557
H7	0.2656	0.2159	J5	0.2581	0.2365	K6	0.2720	0.2442
	0.2739	0.2144		0.2669	0.2349		0.2807	0.2424
	0.2789	0.2229		0.2720	0.2442		0.2862	0.2520
	0.2705	0.2244		0.2631	0.2459		0.2773	0.2538
I5	0.2533	0.2275	J6	0.2669	0.2349	K7	0.2807	0.2424
	0.2620	0.2259		0.2755	0.2332		0.2894	0.2407
	0.2669	0.2349		0.2807	0.2424		0.2949	0.2502
	0.2581	0.2365		0.2720	0.2442		0.2862	0.2520

Group	Cx	Cy	Group	Cx	Cy	Group	Cx	Cy
L5	0.2683	0.2557	N6	0.2886	0.2743	Q7	0.3102	0.2942
	0.2773	0.2538		0.2977	0.2722		0.3195	0.2919
	0.2828	0.2638		0.3039	0.2830		0.3263	0.3034
	0.2737	0.2658		0.2946	0.2852		0.3169	0.3058
L6	0.2773	0.2538	N7	0.2977	0.2722	R5	0.2975	0.3108
	0.2862	0.2520		0.3068	0.2702		0.3073	0.3083
	0.2918	0.2619		0.3130	0.2808		0.3141	0.3207
	0.2828	0.2638		0.3039	0.2830		0.3042	0.3233
L7	0.2862	0.2520	P5	0.2851	0.2874	R6	0.3073	0.3083
	0.2949	0.2502		0.2946	0.2852		0.3169	0.3058
	0.3007	0.2600		0.3008	0.2965		0.3239	0.3180
	0.2918	0.2619		0.2912	0.2989		0.3141	0.3207
M5	0.2737	0.2658	P6	0.2946	0.2852	R7	0.3169	0.3058
	0.2828	0.2638		0.3039	0.2830		0.3263	0.3034
	0.2886	0.2743		0.3102	0.2942		0.3334	0.3154
	0.2793	0.2764		0.3008	0.2965		0.3239	0.3180
M6	0.2828	0.2638	P7	0.3039	0.2830	S5	0.3042	0.3233
	0.2918	0.2619		0.3130	0.2808		0.3141	0.3207
	0.2977	0.2722		0.3195	0.2919		0.3212	0.3336
	0.2886	0.2743		0.3102	0.2942		0.3111	0.3364
M7	0.2918	0.2619	Q5	0.2912	0.2989	S6	0.3141	0.3207
	0.3007	0.2600		0.3008	0.2965		0.3239	0.3180
	0.3068	0.2702		0.3073	0.3083		0.3311	0.3308
	0.2977	0.2722		0.2975	0.3108		0.3212	0.3336
N5	0.2793	0.2764	Q6	0.3008	0.2965	S7	0.3239	0.3180
	0.2886	0.2743		0.3102	0.2942		0.3334	0.3154
	0.2946	0.2852		0.3169	0.3058		0.3409	0.3280
	0.2851	0.2874		0.3073	0.3083		0.3311	0.3308

Group Name on Label

Example: 5J-H5-P-15

Brightness	Color Chromaticity	Peak Wavelength	Forward Voltage
5J	H5	P	15

Relative Spectral Emission ⁶⁾

$\Phi_{rel} = f(\lambda); I_F = 200 \text{ mA}; T_S = 25 \text{ }^\circ\text{C}$

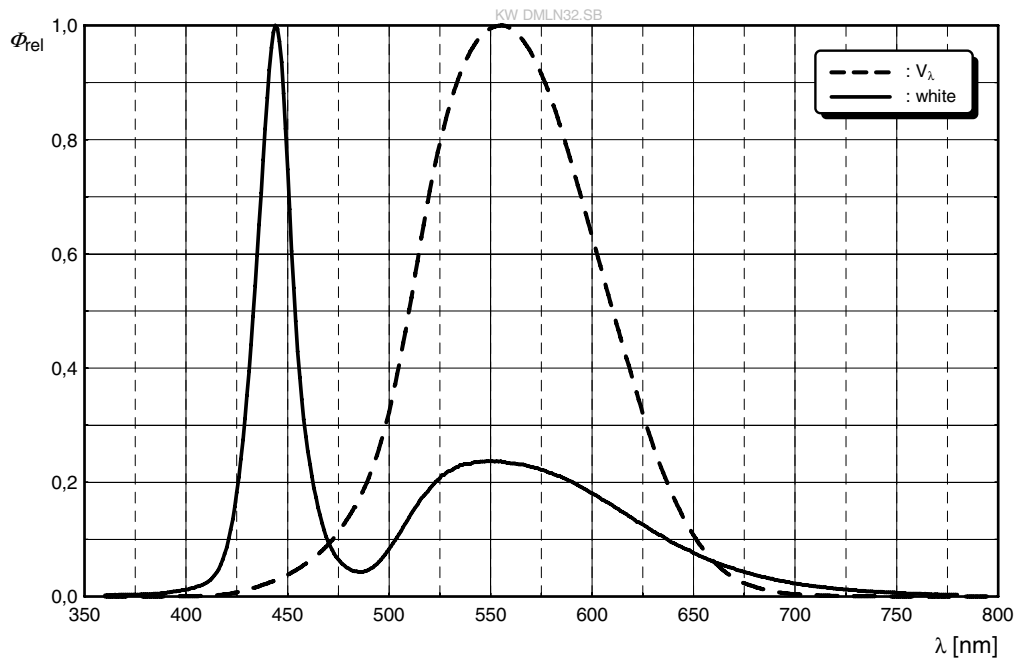

Radiation Characteristics ⁶⁾

$I_{rel} = f(\phi); T_S = 25 \text{ }^\circ\text{C}$

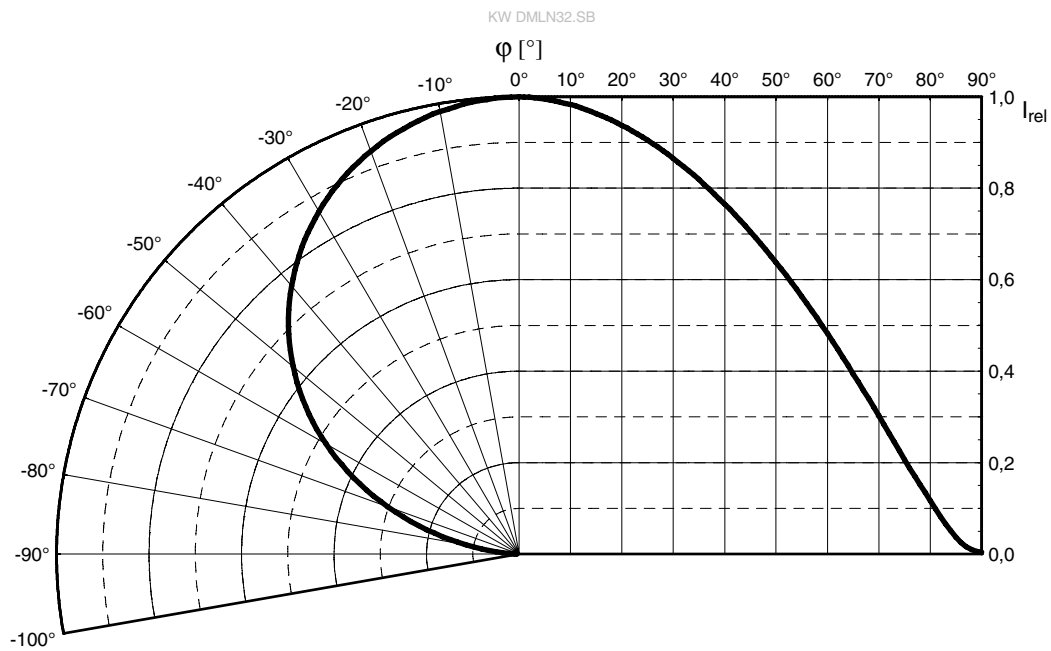

Forward current 6), 8)

$I_F = f(V_F); T_S = 25\text{ °C}$

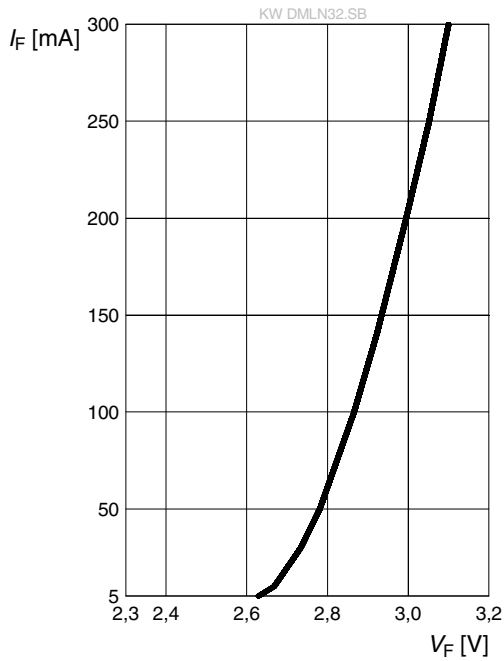

Relative Luminous Flux 6), 8)

$\Phi_V / \Phi_V(200\text{ mA}) = f(I_F); T_S = 25\text{ °C}$

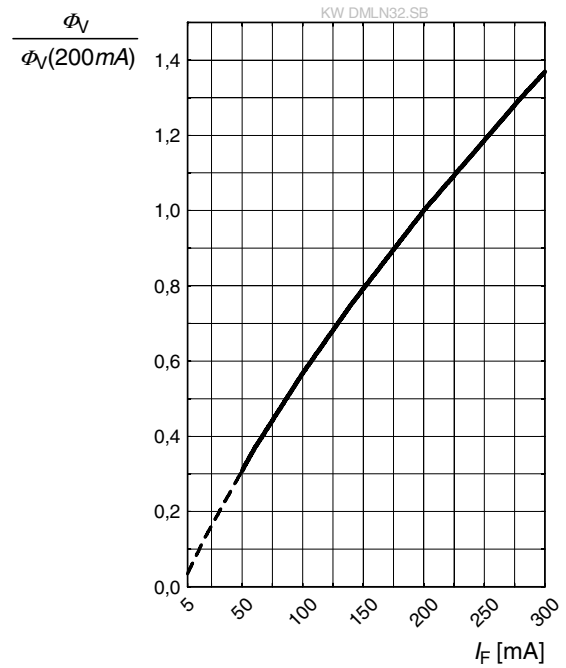

Chromaticity Coordinate Shift 6)

$\Delta C_x, \Delta C_y = f(I_F); T_S = 25\text{ °C}$

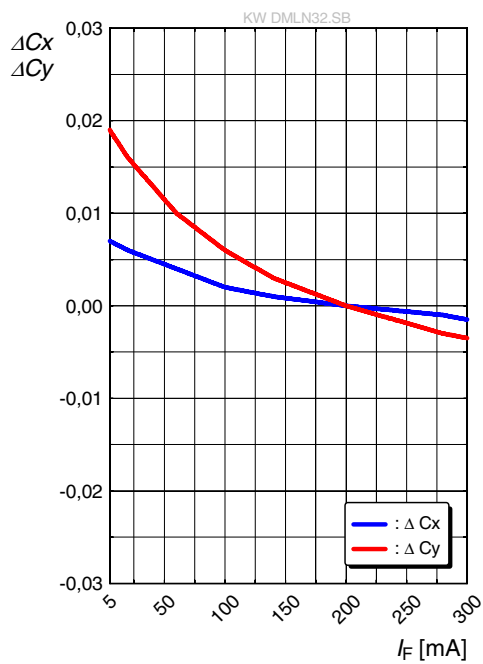

Forward Voltage ⁶⁾

$$\Delta V_F = V_F - V_F(25\text{ °C}) = f(T_j); I_F = 200\text{ mA}$$

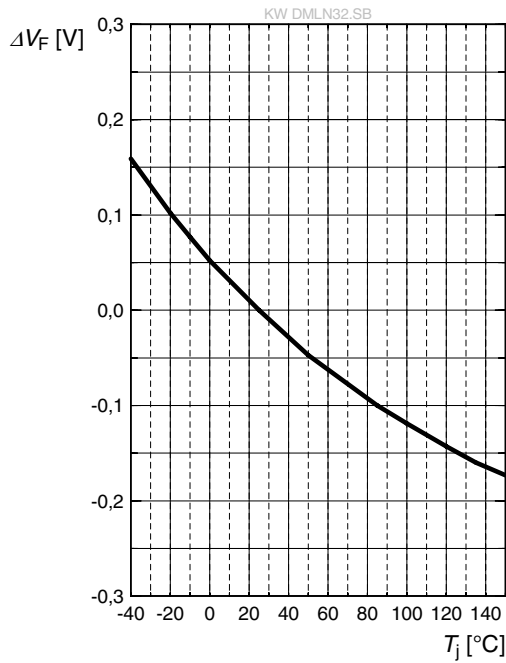

Relative Luminous Flux ⁶⁾

$$\Phi_V / \Phi_V(25\text{ °C}) = f(T_j); I_F = 200\text{ mA}$$

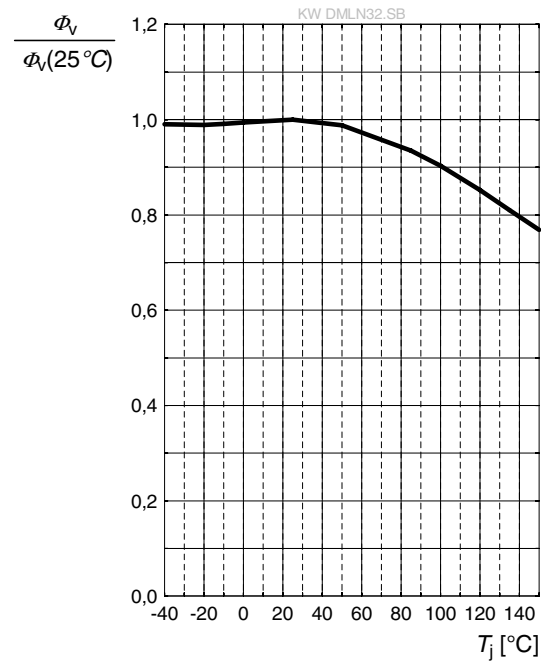

Chromaticity Coordinate Shift ⁶⁾

$$\Delta C_x, \Delta C_y = f(T_j); I_F = 200\text{ mA}$$

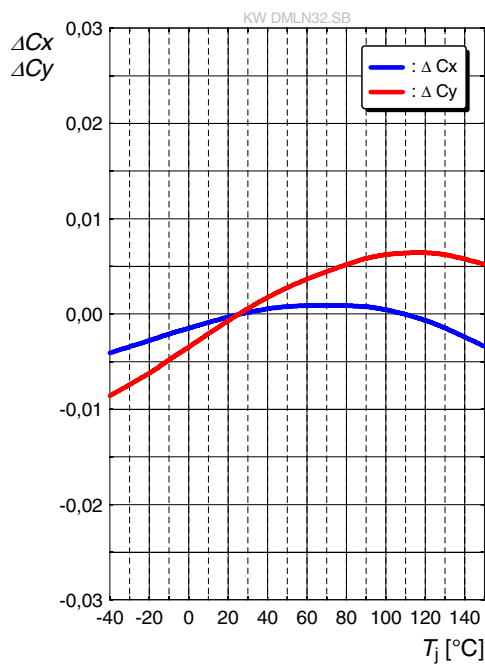

Max. Permissible Forward Current

$$I_F = f(T)$$

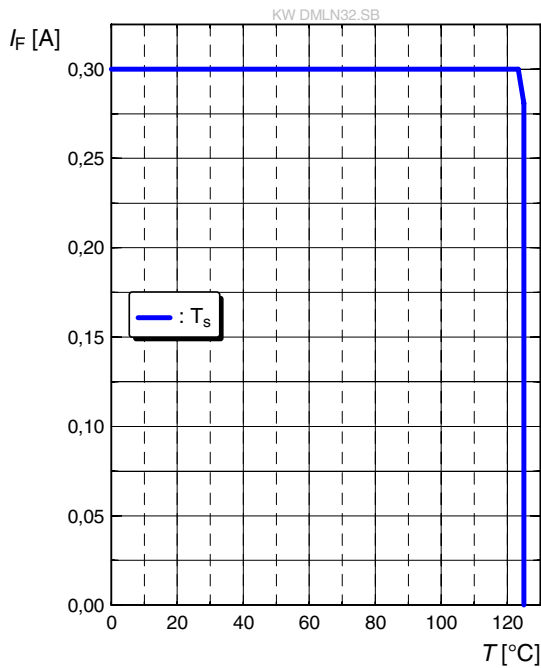

Permissible Pulse Handling Capability

$$I_F = f(t_p); D: \text{Duty cycle}$$

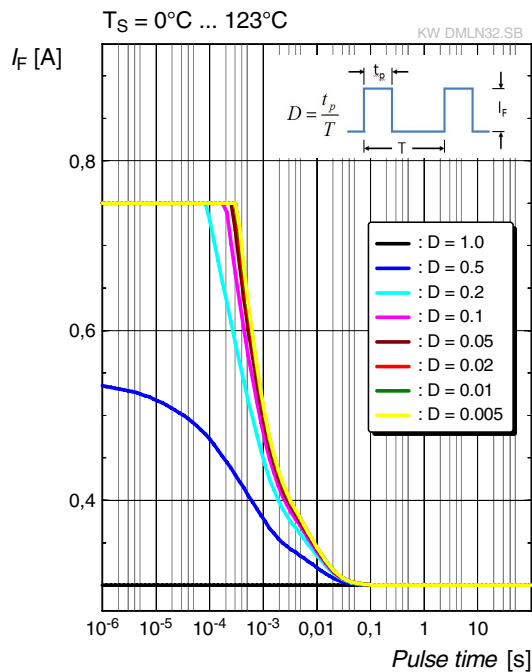

Permissible Pulse Handling Capability

$$I_F = f(t_p); D: \text{Duty cycle}$$

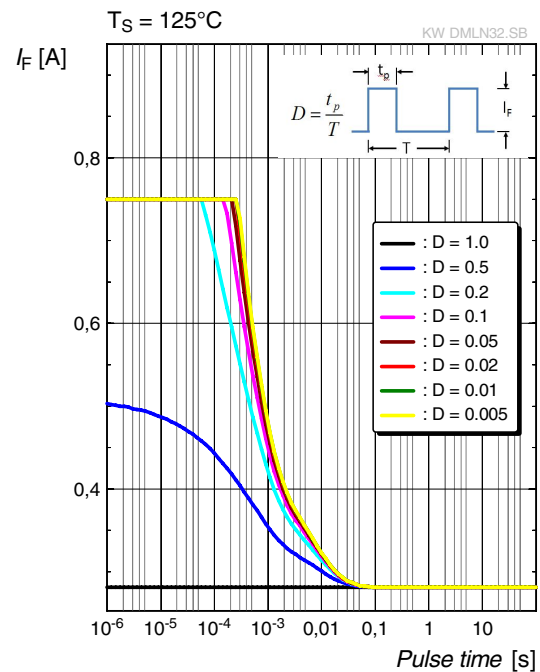

Dimensional Drawing ⁹⁾

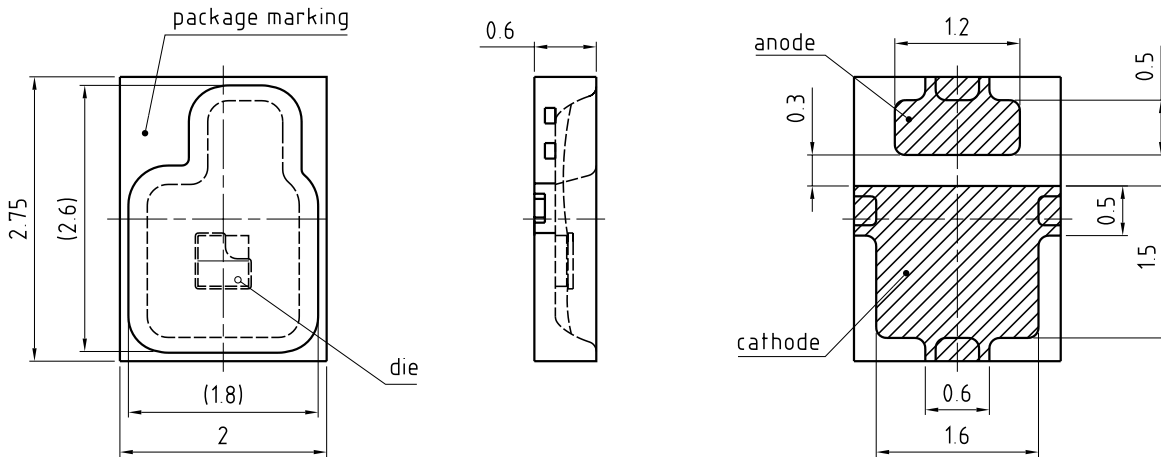

General tolerance ± 0.1

Lead finish Au 

C67062-A0116-A17-01

Approximate Weight: 12.0 mg

Corrosion test: Class: 3B
 Test condition: 40°C / 90 % RH / 15 ppm H₂S / 14 days (stricter than IEC 60068-2-43)

ESD advice: The device is protected by ESD device which is connected in parallel to the Chip.

Electrical internal circuit

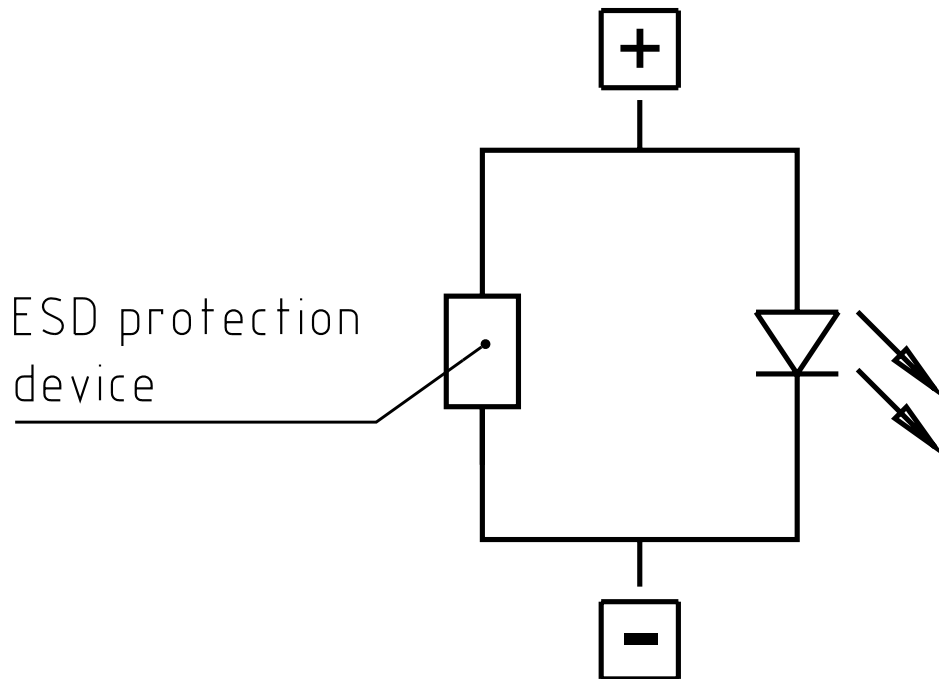

Recommended Solder Pad ⁹⁾

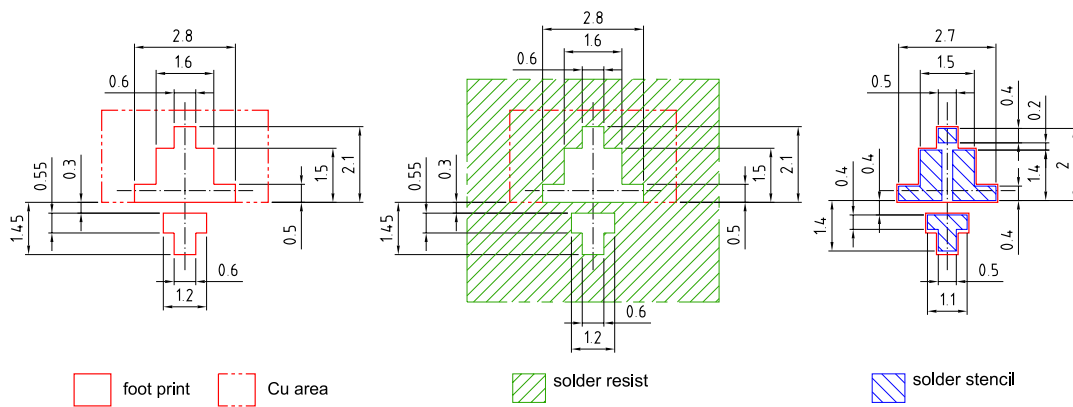

Component Location on Pad

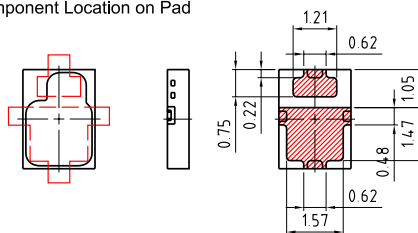

E062.3010.181 -02

For superior solder joint connectivity results we recommend soldering under standard nitrogen atmosphere. Package not suitable for ultra sonic cleaning.

Reflow Soldering Profile

Product complies to MSL Level 2 acc. to JEDEC J-STD-020E

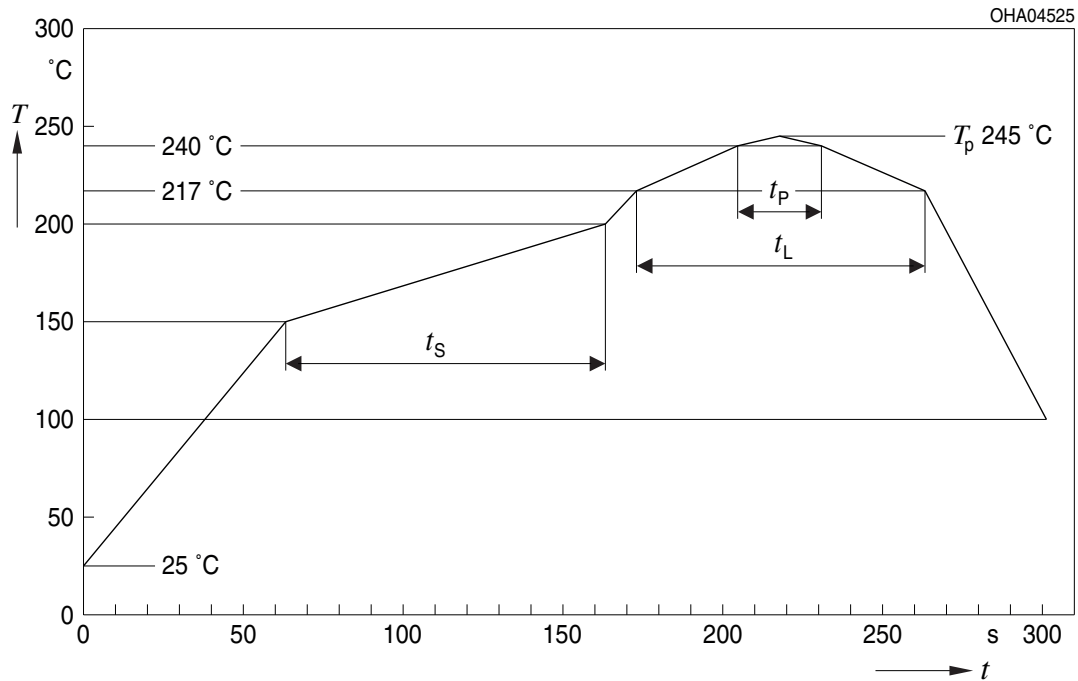

Profile Feature	Symbol	Pb-Free (SnAgCu) Assembly			Unit
		Minimum	Recommendation	Maximum	
Ramp-up rate to preheat ^{*)} 25 °C to 150 °C			2	3	K/s
Time t_s T_{Smin} to T_{Smax}	t_s	60	100	120	s
Ramp-up rate to peak ^{*)} T_{Smax} to T_p			2	3	K/s
Liquidus temperature	T_L		217		°C
Time above liquidus temperature	t_L		80	100	s
Peak temperature	T_p		245	260	°C
Time within 5 °C of the specified peak temperature $T_p - 5$ K	t_p	10	20	30	s
Ramp-down rate* T_p to 100 °C			3	6	K/s
Time 25 °C to T_p				480	s

All temperatures refer to the center of the package, measured on the top of the component

* slope calculation DT/Dt : Dt max. 5 s; fulfillment for the whole T-range

Taping ⁹⁾

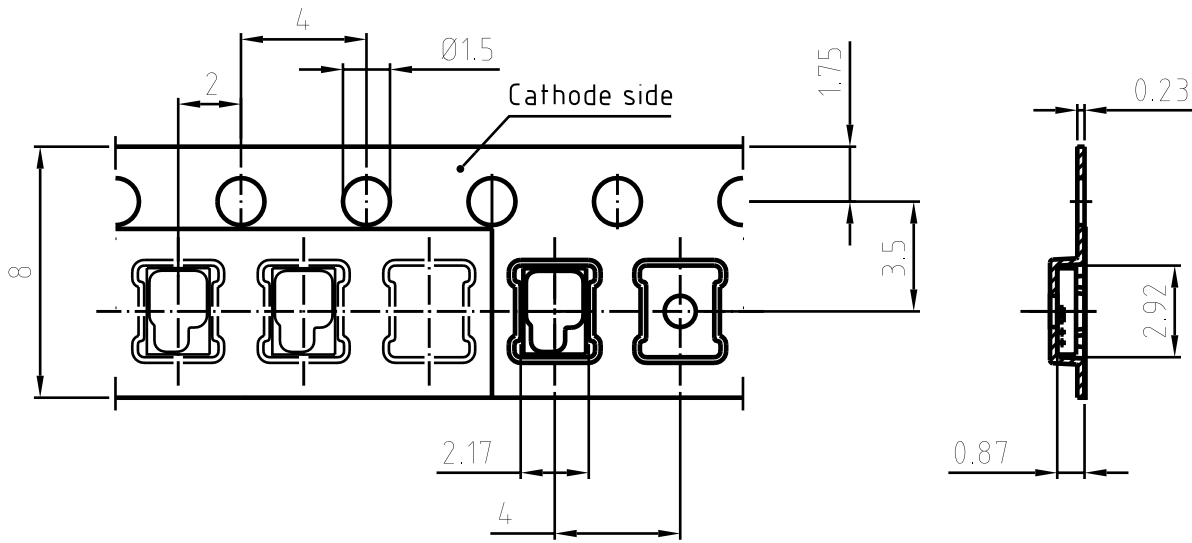

C67062-A0116-B9-04

Tape and Reel ¹⁰⁾

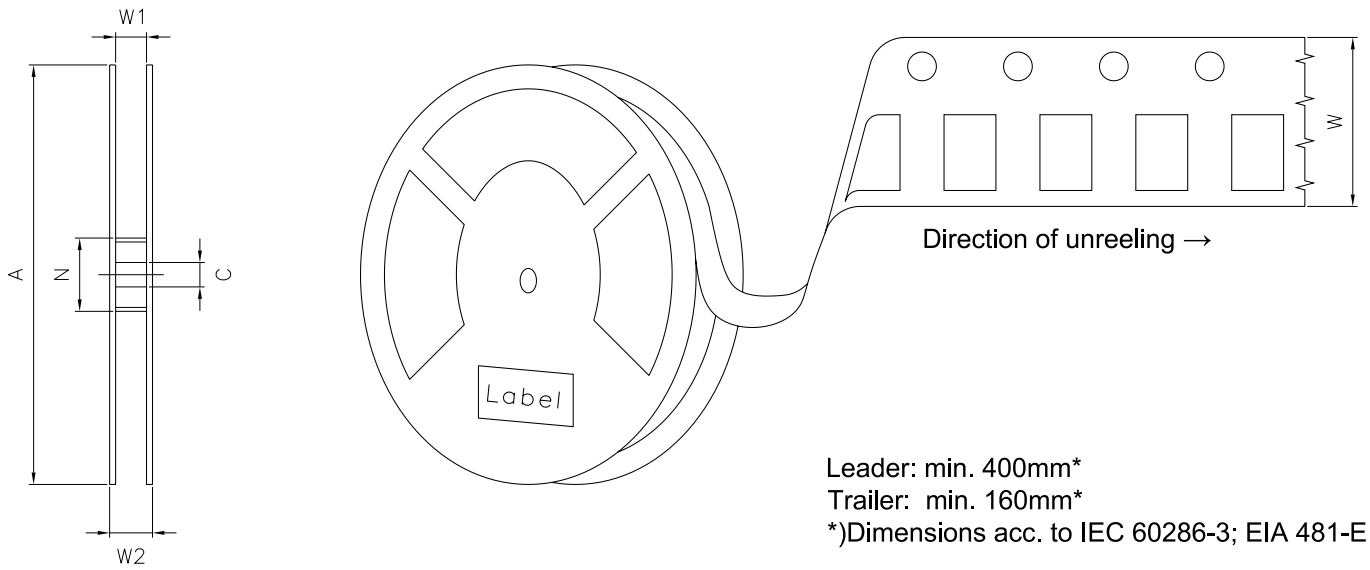

Reel dimensions [mm]

A	W	N _{min}	W ₁	W _{2 max}	Pieces per PU
180 mm	8 + 0.3 / - 0.1	60	8.4 + 2	14.4	1000

Barcode-Product-Label (BPL)

OSRAM Opto Semiconductors LX XXXX BIN1: XX-XX-X-XXX-X

RoHS Compliant

(6P) BATCH NO: 1234567890 ML Temp ST
X XXX °C X

(1T) LOT NO: 1234567890 (9D) D/C: 1234

(X) PROD NO: 123456789(Q)QTY: 9999 (G) GROUP: XX-XX-X-X

Pack: RXX
DEMY XXX
X_X123_1234.1234 X



OHA04563

Dry Packing Process and Materials ⁹⁾

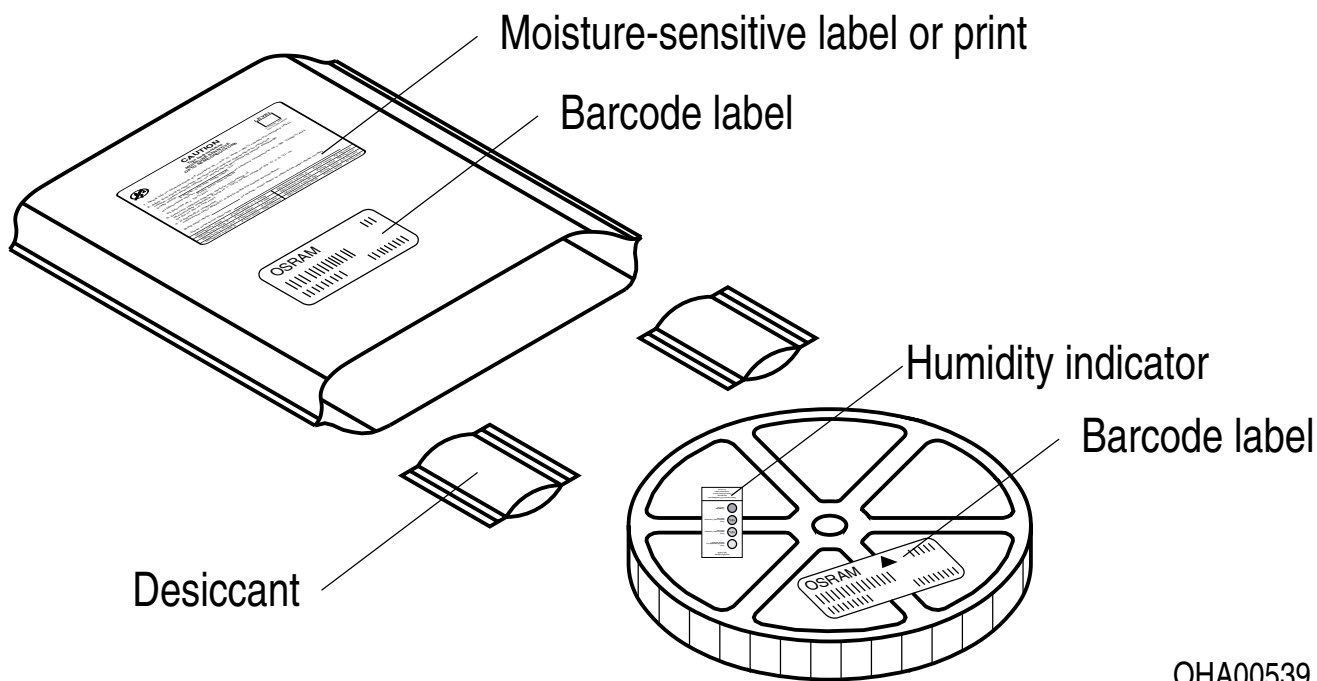

OHA00539

Moisture-sensitive product is packed in a dry bag containing desiccant and a humidity card according JEDEC-STD-033.

Transportation Packing and Materials ⁹⁾

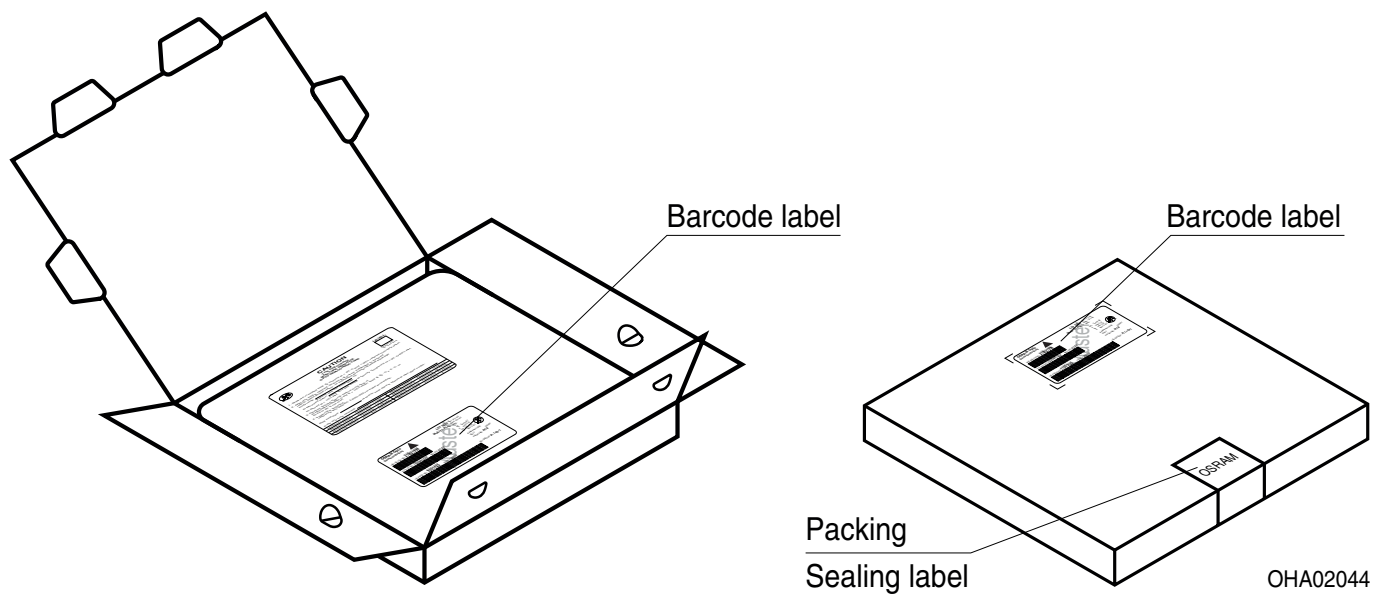

Dimensions of transportation box in mm

Width	Length	Height
200 ± 5 mm	195 ± 5 mm	30 ± 5 mm

Notes

The evaluation of eye safety occurs according to the standard IEC 62471:2006 (photo biological safety of lamps and lamp systems). Within the risk grouping system of this IEC standard, the device specified in this data sheet falls into the class **moderate risk (exposure time 0.25 s)**. Under real circumstances (for exposure time, conditions of the eye pupils, observation distance), it is assumed that no endangerment to the eye exists from these devices. As a matter of principle, however, it should be mentioned that intense light sources have a high secondary exposure potential due to their blinding effect. When looking at bright light sources (e.g. headlights), temporary reduction in visual acuity and afterimages can occur, leading to irritation, annoyance, visual impairment, and even accidents, depending on the situation.

Subcomponents of this device contain, in addition to other substances, metal filled materials including silver. Metal filled materials can be affected by environments that contain traces of aggressive substances. Therefore, we recommend that customers minimize device exposure to aggressive substances during storage, production, and use. Devices that showed visible discoloration when tested using the described tests above did show no performance deviations within failure limits during the stated test duration. Respective failure limits are described in the IEC60810.

For further application related informations please visit www.osram-os.com/appnotes

Disclaimer

Disclaimer

Language english will prevail in case of any discrepancies or deviations between the two language wordings.

Attention please!

The information describes the type of component and shall not be considered as assured characteristics. Terms of delivery and rights to change design reserved. Due to technical requirements components may contain dangerous substances.

For information on the types in question please contact our Sales Organization.

If printed or downloaded, please find the latest version on the OSRAM OS website.

Packing

Please use the recycling operators known to you. We can also help you – get in touch with your nearest sales office.

By agreement we will take packing material back, if it is sorted. You must bear the costs of transport. For packing material that is returned to us unsorted or which we are not obliged to accept, we shall have to invoice you for any costs incurred.

Product safety devices/applications or medical devices/applications

OSRAM OS components are not developed, constructed or tested for the application as safety relevant component or for the application in medical devices.

In case Buyer – or Customer supplied by Buyer– considers using OSRAM OS components in product safety devices/applications or medical devices/applications, Buyer and/or Customer has to inform the local sales partner of OSRAM OS immediately and OSRAM OS and Buyer and /or Customer will analyze and coordinate the customer-specific request between OSRAM OS and Buyer and/or Customer.

Glossary

- 1) **Brightness:** Brightness values are measured during a current pulse of typically 25 ms, with an internal reproducibility of $\pm 8\%$ and an expanded uncertainty of $\pm 11\%$ (acc. to GUM with a coverage factor of $k = 3$).
- 2) **Reverse Operation:** Reverse Operation of 10 hours is permissible in total. Continuous reverse operation is not allowed.
- 3) **Chromaticity coordinate groups:** Chromaticity coordinates are measured during a current pulse of typically 25 ms, with an internal reproducibility of ± 0.005 and an expanded uncertainty of ± 0.01 (acc. to GUM with a coverage factor of $k = 3$).
- 4) **Forward Voltage:** The forward voltage is measured during a current pulse of typically 8 ms, with an internal reproducibility of $\pm 0.05\text{ V}$ and an expanded uncertainty of $\pm 0.1\text{ V}$ (acc. to GUM with a coverage factor of $k = 3$).
- 5) **Thermal Resistance:** $R_{th\ max}$ is based on statistic values (6σ).
- 6) **Typical Values:** Due to the special conditions of the manufacturing processes of semiconductor devices, the typical data or calculated correlations of technical parameters can only reflect statistical figures. These do not necessarily correspond to the actual parameters of each single product, which could differ from the typical data and calculated correlations or the typical characteristic line. If requested, e.g. because of technical improvements, these typ. data will be changed without any further notice.
- 7) **Wavelength:** The wavelength is measured at a current pulse of typically 25 ms, with an internal reproducibility of $\pm 0.5\text{ nm}$ and an expanded uncertainty of $\pm 1\text{ nm}$ (acc. to GUM with a coverage factor of $k = 3$).
- 8) **Characteristic curve:** In the range where the line of the graph is broken, you must expect higher differences between single devices within one packing unit.
- 9) **Tolerance of Measure:** Unless otherwise noted in drawing, tolerances are specified with ± 0.1 and dimensions are specified in mm.
- 10) **Tape and Reel:** All dimensions and tolerances are specified acc. IEC 60286-3 and specified in mm.

Published by OSRAM Opto Semiconductors GmbH EU RoHS and China RoHS compliant product
Leibnizstraße 4, D-93055 Regensburg
www.osram-os.com © All Rights Reserved.



此产品符合欧盟 RoHS 指令的要求；
按照中国的相关法规和标准，不含有毒有害物质或元素。